





























Architectural Collection 2022















INDOOR







(N) Produktneuheit
Prodotto novità

(E) Essenzielles Produkt
Prodotto essenziale

<p>Modulare Systeme Sistemi modulari</p>	 <p>(N)</p> <p>Iris</p> <p>041</p>	 <p>(N)</p> <p>Apex</p> <p>053</p>		
<p>Strahler Proiettori</p>	 <p>Atom</p> <p>073</p>	 <p>(N)</p> <p>Iris</p> <p>101</p>	 <p>(N) (E)</p> <p>Tak</p> <p>107</p>	 <p>Track</p> <p>111</p>
<p>Niederspannung Bassa tensione</p>	 <p>Atom Low Voltage</p> <p>127</p>	 <p>Kiva Low Voltage</p> <p>127</p>	 <p>(N)</p> <p>Iris Low Voltage</p> <p>128</p>	 <p>(N)</p> <p>Bento Low Voltage</p> <p>128</p>
	 <p>Infinite Low Voltage</p> <p>129</p>	 <p>Vela Low Voltage</p> <p>129</p>	 <p>Punto Low Voltage</p> <p>130</p>	 <p>Veneto Low Voltage</p> <p>130</p>

	 <p>(N) Track Low Voltage 131</p>			
Downlights Downlights	 <p>Sia 159</p>	 <p>Biwa 176</p>	 <p>(N) (E) Veo 181</p>	 <p>Vo1 187</p>
	 <p>(N) Play 191</p>	 <p>(E) Lite 231</p>	 <p>Out 234</p>	 <p>(E) Dome 236</p>
	 <p>(E) Split 239</p>	 <p>(E) Ges 240</p>	 <p>(N) Bento 245</p>	 <p>Luno 269</p>
	 <p>Finelight 281</p>	 <p>(N) Multidir Evo 287</p>		

















Pendelleuchten Sospensioni	 (N) Iris 297	 Pek 300	 Luno 302	
Wandleuchten/ Deckenleuchten Lampade da parete/ Plafoniere	 (N) Iris 307	 Maaï 312	 Leco 314	 Luno 317
	 Ges 322	 (N) Play 323	 Exit 324	
Module Moduli	 In 328			
Signalisierung Segnaletica	 Paso 332	 Bat 336	 Sign 340	 Secret 341















	 <p>Step 342</p>			
<p>Lineare Beleuchtungssysteme Sistemi lineari d'illuminazione</p>	 <p>(N) Infinite Pro 345</p>	 <p>(N) Apex 371</p>	 <p>Lineal 388</p>	 <p>Taglio Di Luce 393</p>
<p>LED-Bänder Strisce LED</p>	 <p>Asai 415</p>	 <p>On 425</p>		

OUTDOOR



 **Produktneuheit**
Prodotto novità















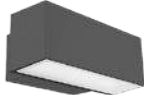

 **Esenzielles Produkt**
Prodotto essenziale















<p>Modulare Systeme Sistemi modulari</p>	 <p> Max 451</p>	 <p> Modis 471</p>		
<p>Lineare Beleuchtungssysteme Sistemi lineari d'illuminazione</p>	 <p>Vercle 487</p>	 <p> Taglio 493</p>	 <p> Convert 517</p>	 <p>Tron 522</p>
	 <p>Afrodita 527</p>	 <p>Mex 533</p>		
<p>Strahler Proiettori</p>	 <p>Cube Pro 539</p>	 <p>Blade 547</p>	 <p>Hubble 551</p>	<p> Max 561</p>

	 <p>(N)</p> <p>Modis</p> <p>567</p>	 <p>Thor</p> <p>573</p>	 <p>(N)</p> <p>Zoom</p> <p>579</p>	 <p>Micro</p> <p>583</p>
	 <p>(E)</p> <p>Helio</p> <p>586</p>	 <p>Esparta</p> <p>588</p>	 <p>(N) (E)</p> <p>Suv</p> <p>589</p>	
<p>Unterwasser- leuchten Lucisommergibili</p>	 <p>Aqua</p> <p>592</p>			
<p>Deckenein- bauleuchten Incassi a soffitto</p>	 <p>(N)</p> <p>Max</p> <p>597</p>	 <p>Dako</p> <p>603</p>	 <p>Gea</p> <p>608</p>	
<p>Wandeinbau- leuchten Incassi a parete</p>	 <p>Bat</p> <p>613</p>	 <p>Tiny</p> <p>618</p>	 <p>Pixel</p> <p>620</p>	 <p>Rim</p> <p>623</p>

	 <p>Arc 627</p>	 <p>Micenas 631</p>	 <p>Gea 635</p>	
Bodeneinbau- leuchten Incassi a pavimento	 <p>(N) Max 639</p>	 <p>Gea 645</p>	 <p>(E) Kay 663</p>	 <p>Ios 667</p>
	 <p>Pixel 671</p>	 <p>Xena 674</p>	 <p>Rim 677</p>	
Uplights für Aufsatzmontage Uplight di superficie	 <p>(N) Soul 683</p>	 <p>Roxel 686</p>	 <p>Xena LED 688</p>	
Pollerleuchten Faretti	 <p>(N) Rek 693</p>	 <p>Compact 700</p>	 <p>Row 703</p>	 <p>Simenti 706</p>

	 <p>(N)</p> <p>Modis</p> <p>708</p>	 <p>(N)</p> <p>Newton</p> <p>711</p>	 <p>Cilin</p> <p>717</p>	 <p>(E)</p> <p>Dan</p> <p>719</p>
	 <p>Lyon</p> <p>723</p>	 <p>Cubik</p> <p>724</p>	 <p>Nott</p> <p>728</p>	 <p>(E)</p> <p>Balizas</p> <p>730</p>
	 <p>Diago</p> <p>732</p>	 <p>Priap</p> <p>733</p>	 <p>Helion</p> <p>734</p>	 <p>Cubus</p> <p>734</p>
	 <p>Way</p> <p>735</p>	 <p>Invisible</p> <p>736</p>	 <p>Juncus</p> <p>739</p>	
Mastleuchten Lampioni	 <p>(N)</p> <p>Modis</p> <p>742</p>	 <p>Juncus</p> <p>744</p>	 <p>Zigzag</p> <p>747</p>	 <p>Citizen</p> <p>752</p>

	 <p>Lyon 753</p>	 <p>Proud 754</p>		
Wandleuchten Lampade da parete	 <p>(N) Max 759</p>	 <p>(N) Sam 765</p>	 <p>Cosmos 769</p>	 <p>(N) Afrodita 773</p>
	 <p>(E) Nemesis 786</p>	 <p>Wilson 788</p>	 <p>Clous 790</p>	 <p>Cubus 791</p>
	 <p>Finestra 793</p>	 <p>Moal 797</p>	 <p>Arc 800</p>	 <p>(E) Kössel 802</p>
	 <p>(N) Modis 807</p>	 <p>Blade 812</p>	 <p>Skat 815</p>	 <p>Mega 818</p>

	 <p>Venus 820</p>	 <p>Diago 820</p>	 <p>Simenti 821</p>	 <p>Darwin 821</p>
	 <p>(N) (E) Basic 823</p>	 <p>Curie 830</p>		
Deckenleuchten Plafoniere	 <p>(N) Modis 835</p>	 <p>Mega 841</p>	 <p>Max 845</p>	 <p>(N) Cosmos 848</p>
	 <p>(N) Soul 850</p>	 <p>Solid 852</p>	 <p>(N) Afrodita 854</p>	 <p>(E) Kössel 855</p>
	 <p>(N) (E) Basic 856</p>			

Chillout
Chillout



Rack

861



Moal

881



Cisne

884



Barcino















887



Moonlight

887

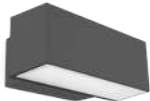
EMERGENCY

<p>Notfallbe- leuchtung Apparecchi di emergenza</p>	 <p>Redo 897</p>	 <p>Deco 903</p>	 <p>Flag 909</p>	 <p>Star 909</p>
	 <p>Deco Track 910</p>	 <p>Line 912</p>	 <p>Leco 914</p>	
<p>Technische Notbeleuchtung Illuminazione tecnica di emergenza</p>	 <p>Play 916</p>	 <p>Infinite Pro 917</p>	 <p>Sia 918</p>	 <p>Bento 919</p>
	 <p>Ⓝ Veo 919</p>	 <p>Afrodita 920</p>	 <p>Solid 920</p>	 <p>Emergency Kits 921</p>



Ein Katalog des Lichts

Un catalogo luminoso

Licht ist die harmonische und lautlose Komposition, die einem Ambiente den letztendlichen Eindruck gibt. Licht beeinflusst uns, löst Emotionen aus und begleitet uns in jedem Moment. Licht ist immer da als der elegante und dezente Hauptdarsteller in jedem Ambiente.

La luce è la composizione armonica e silenziosa che delinea la sensazione finale di uno scenario. La luce ci condiziona, ci provoca un'emozione, ci accompagna in ogni momento. La luce è quella presenza discreta che, con eleganza e senza chiedere, diventa protagonista di tutti gli scenari possibili.

Hochwertiges Licht für jeden Raum

Una luce di
qualità per
ogni spazio

LEDS C4 versteht diese natürliche Kraft des Lichts als Herausforderung. Wir wissen, wie wichtig gutes Licht für jeden Moment unseres Lebens ist und für die Räume, in denen es stattfindet: Wohnungen, Büros, Geschäfte, öffentliche Räume, Außenbereiche, Krankenhäuser und sogar Boote. Jeder Raum braucht eine strategisch geplante Beleuchtung, um seinen wichtigsten Zweck zu erfüllen: das Wohlbefinden der darin lebenden Menschen. Wir haben mehr als 50 Jahren Erfahrung mit Beleuchtung und arbeiten jeden Tag daran, das beste Licht anzubieten.

Per LEDS C4 questo potere naturale della luce diventa una sfida. Conosciamo l'importanza di una buona luce in ogni momento della nostra vita e degli spazi che la compongono: case, uffici, attività private, spazi pubblici, aree esterne, ospedali e persino barche. Ogni spazio richiede un'illuminazione strategicamente progettata per raggiungere il suo obiettivo più grande: prendersi cura delle persone che lo abitano. Con un'esperienza di oltre 50 anni dedicata all'illuminazione, lavoriamo ogni giorno per offrire sempre la luce migliore.



Design, Technologie und Service Design, tecnologia e servizio



LEDS C4 hat mehr als ein halbes Jahrhundert Erfahrung in der Entwicklung von kundenspezifischen Projekten, die im Kultur-, Hotel-, Bau- und Einrichtungssektor große Anerkennung finden. Dieses Wissen bildet die Grundlage für die kontinuierliche Erforschung der Möglichkeiten des Lichts. Dadurch haben wir ein Beleuchtungsangebot der neuesten Generation in Bezug auf Design (modulare Elemente, die sich an Räume anpassen), Technologie (fortschrittliche digitale Steuerung und Konnektivität) und Service (LEDS C4 begleitet Sie während des gesamten Prozesses und gestaltet diesen unkompliziert und agil).

LEDS C4 vanta un'esperienza di oltre mezzo secolo nello sviluppo di progetti su misura con grande riconoscimento sia nel settore della cultura, che nei settori alberghiero, contract e residenziale. Questa conoscenza ci fornisce le basi per indagare continuamente sulle possibilità della luce. Grazie a questo, realizziamo proposte illuminotecniche avanzate in termini di design (proposte modulari che si adattano agli spazi), tecnologia (con sviluppo digitale avanzato di controllo e connettività) e servizio (con la certezza che LEDS C4 accompagna l'intero processo, rendendolo facile e agile).

Nähe und Nachhaltigkeit

Vicinanza e sostenibilità



Die Geschichte und Entwicklung von LEDS C4 ist untrennbar verbunden mit La Segarra, einer Hochebene in der Provinz Lleida umgeben von Getreidefeldern, Kiefern und Steineichen. In dieser natürlichen Umgebung verstärken sich die Möglichkeiten eines Unternehmens, das seine Mitarbeiter mit einem nahbaren und inspirierenden Arbeitsumfeld motiviert. Wir engagieren uns auch für die Erfüllung der 17 Ziele für nachhaltige Entwicklung (SDGs), die 2015 von den Vereinten Nationen festgelegt wurden. Zu diesem Zweck ergreift LEDS C4 eine Reihe spezifischer Maßnahmen: Verringerung der CO₂-Bilanz durch Installation von Beleuchtungsanlagen mit LED-Sensoren zur Anwesenheitserkennung, Verwendung ökologischer und nachhaltiger Verpackungen, Verringerung des Papierverbrauchs bei Transaktionen, Sammelguttransporte für mehr Nachhaltigkeit, Simulation von natürlichem Licht in der Arbeitsumgebung, Implementierung der 5A, um die Arbeitsbedingungen zu verbessern, Verwendung nachhaltiger Materialien in unseren Produkten und soziales Engagement in Zusammenarbeit mit unabhängigen Einrichtungen.

La storia e lo sviluppo di LEDS C4 è legata all'ambientazione di La Segarra, un altopiano in provincia di Lleida, circondato da campi di cereali, pini e lecci. In questo ambiente naturale si rafforzano le fondamenta di un'azienda che coinvolge i propri lavoratori in una motivazione comune, favorendo un ambiente di lavoro vicino e stimolante. Lavoriamo anche per raggiungere i 17 obiettivi definiti dall'ONU nel 2015 che promuovono lo sviluppo sostenibile (OSS). In tal senso, LEDS C4 realizza una serie di azioni specifiche come la riduzione dell'impronta di carbonio con l'installazione di illuminazione con sensori di rilevamento di presenza a LED, l'utilizzo di imballaggi ecologici e sostenibili, la riduzione dell'uso di carta nelle transazioni, la condivisione dei carichi nei trasporti per renderli più sostenibili, simulare la luce naturale nell'ambiente di lavoro, promuovere il rispetto delle 5S per migliorare le condizioni di lavoro, utilizzare materiali sostenibili nei nostri prodotti e sviluppare azioni socialmente impegnate con entità autonome.

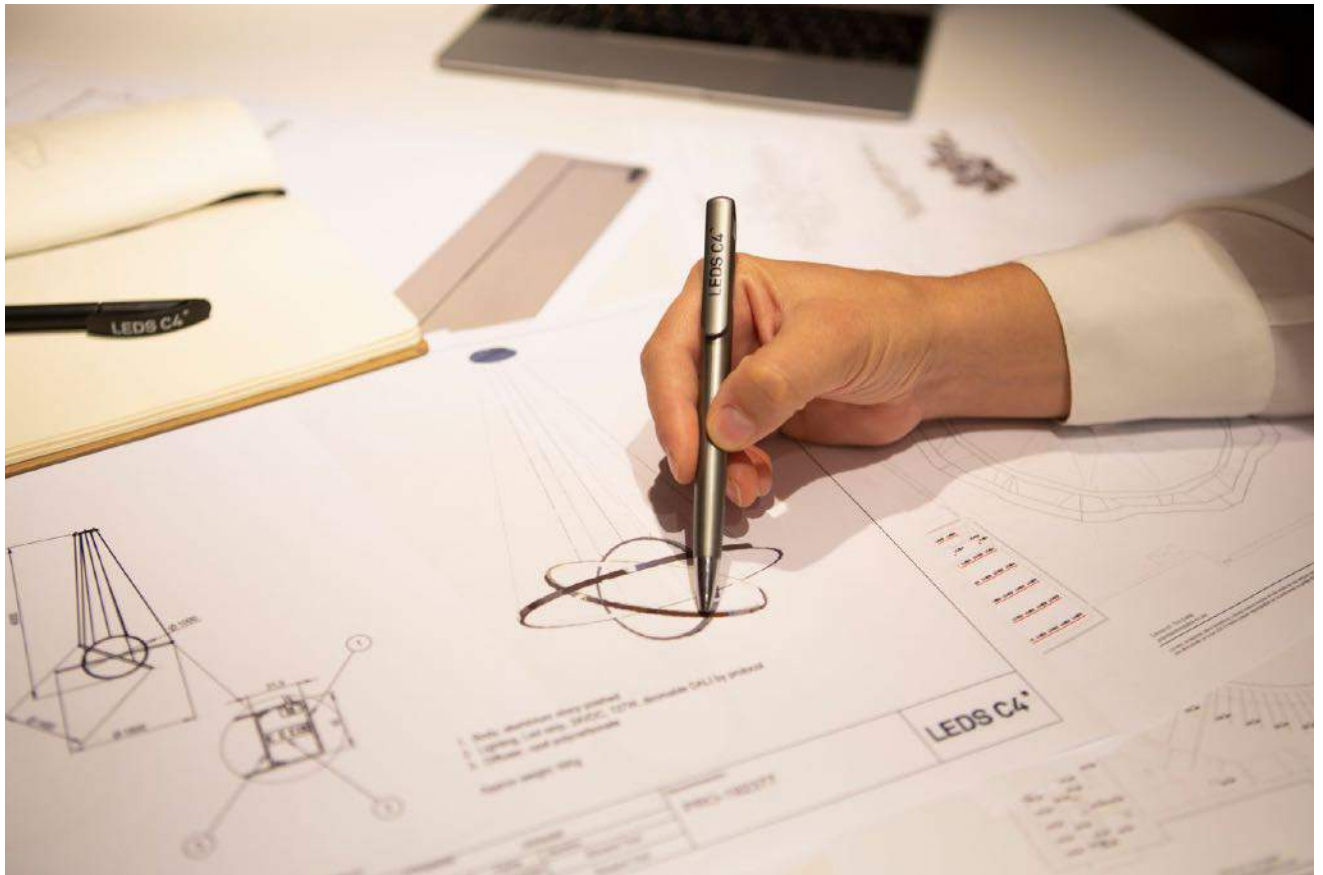

Das Team Il team

LEDS C4 besteht aus einem großartigen Team mit einer gemeinsamen Motivation: die Erforschung der unendlichen Möglichkeiten des Lichts und seiner Anwendungen zur Verbesserung unseres Lebens in allen Bereichen. Aus diesem Grund arbeiten wir nicht nur intern mit Fachleuten der Branche zusammen, sondern auch mit renommierten externen Partnern, die auf internationaler Ebene an der Gestaltung unserer Produkte sowie an der Strategie und Technologie unserer Projekte und unserer Marke mitwirken.

LEDS C4 è composta da un grande team umano che lavora per una motivazione comune: esplorare le infinite possibilità della luce e le sue applicazioni per migliorare la nostra vita da tutti i punti di vista. Per questo motivo, non solo lavoriamo internamente con professionisti del settore, ma abbiamo anche collaboratori di riconosciuto prestigio, che collaborano alla progettazione dei nostri prodotti e alla strategia e tecnologia dei nostri progetti e del nostro marchio a livello internazionale.

Smart Lighting

Vorteile von Steuerung und Konnektivität Vantaggi del controllo e della connettività

Die Beleuchtung ist ein Schlüsselement für die Aktivität und das Wohlbefinden des Menschen. Deshalb entwerfen wir bei LEDS C4 Leuchten und haben dabei stets im Blick, wie sie mit ihrer Umgebung interagieren. Die technologische Entwicklung ermöglicht es uns, den Nutzen für Menschen, Gebäude und Organisationen zu maximieren.

L'illuminazione è un elemento fondamentale per l'attività e il benessere delle persone. Per questo alla LEDS C4 disegniamo apparecchi di illuminazioni e sistemi di connettività pensando a come questi interagiscono con il loro ambiente. L'evoluzione della tecnologia ci consente di massimizzare i vantaggi per le persone, gli edifici e le organizzazioni.



Leuchten
Luminarie



Sensoren und Schnittstellen
Sensori e interfacce



Steuerungs- und Konnektivitätssystem
Sistema di controllo e connettività



Cloud/Plattform
Cloud / Piattaforma



Digitale dienste
Servizi digitali



Gesteigertes Wohlbefinden der Menschen Potenza il benessere delle persone

Passt die Beleuchtung an den Biorhythmus des Menschen und an die funktionalen Anforderungen des Raums an.
Adatta l'illuminazione in base ai ritmi biologici delle persone, o alle esigenze funzionali dello spazio.

Ermöglicht ein effizientes Raummanagement und Energieeinsparungen Favorisce una gestione efficiente dello spazio e il risparmio energetico

Sammelt Informationen über die Installation und ermöglicht so die Planung, Anpassung und Verbesserung der verfügbaren Ressourcen.
Raccoglie informazioni sull'impianto, consentendo di pianificare, adattare e migliorare le risorse disponibili.

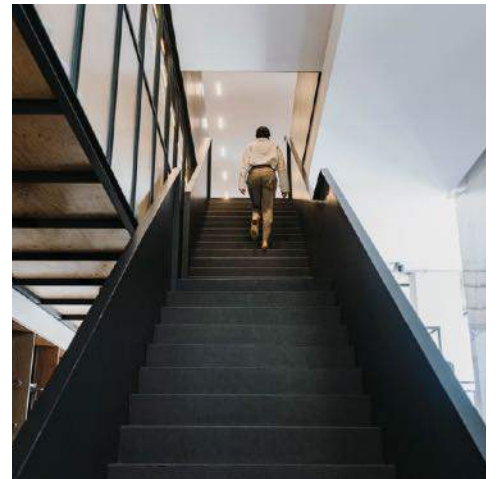

Bringt Ihr Unternehmen voran und steigert die Benutzerfreundlichkeit Stimola la tua organizzazione e migliora l'esperienza degli utenti

Schafft flexible und dynamische Räume, macht Sie so zu einem weiteren Instrument der Kommunikation und verbessert die Wahrnehmung der Nutzer im Raum.
Crea spazi flessibili e dinamici, che possano convertirsi in un ulteriore strumento di comunicazione, migliorando la percezione degli utenti nello spazio.

Funktionen und Dienste

Funzionalità e servizi

Wir machen Ihre Vorstellungen von Beleuchtung, Regelung und Konnektivität wahr und sorgen für einen reibungslosen Projektablauf.

Trasformiamo in realtà le tue idee di illuminazione, controllo e connettività, offrendo il processo completo nei tuoi progetti.



Atmosphären und Wohlbefinden Atmosfera e Well-being

Schaffen Sie unendliche Atmosphären und eine flexible und dynamische Umgebung.
Crea infinite atmosfere e ottieni un ambiente flessibile e dinamico.



Farbmanagement Gestione del colore

Vermitteln Sie mit dem Farbmanagement Emotionen über den Raum.
Trasmetti emozioni attraverso lo spazio grazie alla gestione del colore.

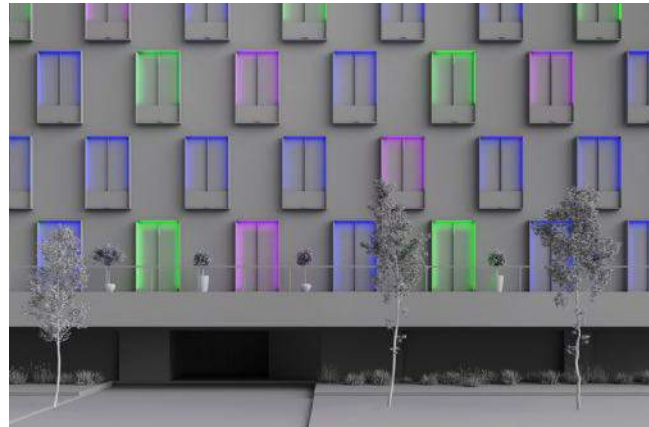

Energieeinsparung Risparmio energetico

Verstehen Sie die verschiedenen Strategien zur Maximierung der Energieeffizienz.
Comprendi le diverse strategie per massimizzare l'efficienza energetica.



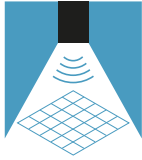

Raummanagement Gestione di spazi

Verbessern Sie Ihr Raumnutzungsmanagement und optimieren Sie alle Ressourcen.
Gestisci meglio l'uso dello spazio e ottimizza tutte le tue risorse.

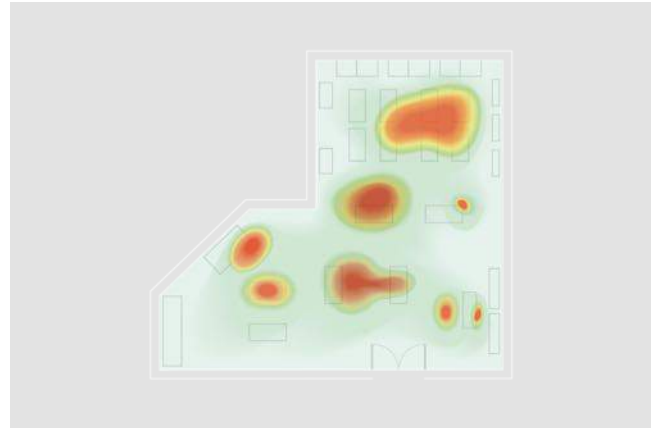

Vorbeugende Wartung Manutenzione preventiva

Überwachen Sie den Zustand der Leuchten, um einen einwandfreien Betrieb sicherzustellen und die Instandhaltung zu planen.

Conosci lo stato degli apparecchi per garantirne il buon funzionamento e la futura conservazione/conservation future.



Push notifications Push notifications

Ein intelligentes Instrument des Proximity-Marketing.

Uno strumento di marketing di prossimità intelligente.



IOL-Kommunikation IOL Communications

Verbesserter Internetzugang in Innenräumen durch Kommunikation zwischen der Beleuchtung und Ihrem mobilen Gerät.

Navigazione di interni grazie alla comunicazione dell'illuminazione con il tuo dispositivo mobile.

Beratung und Inbetriebnahme Servizi di assistenza e messa in funzione



Ready to

Werkskonfiguration der Leuchten und Anschlussgeräte.

Servizio di configurazione di fabbrica degli apparecchi di illuminazione e dei dispositivi connessi.

On site

Dieser Service umfasst die Beratung und Inbetriebnahme vor Ort. Installation der Leuchten nicht inbegriffen.

Servizio che include l'assistenza e la consulenza in presenza in cantiere. Installazione degli apparecchi di illuminazione non inclusa.

Digitale Dienste Servizi digitali

- Energieüberwachung
Monitoraggio energia
- Raummanagement (Space)
Gestione spazi (Space)
- Objektverfolgung
Controllo di oggetti



Atmosphären und Wohlbefinden

Atmosfera e Well-being



Mit einem Lichtsteuerungssystem und der Möglichkeit, die Intensität oder Farbtemperatur der Leuchten zu regulieren (Tunable White), wird der Raum flexibler und dynamischer, um sich den wechselnden Bedürfnissen anzupassen.

Con un sistema di controllo dell'illuminazione e la possibilità di regolare l'intensità o la temperatura di colore degli apparecchi (tunable White), lo spazio guadagna in flessibilità e dinamismo per adattarsi a esigenze mutevoli.



Strategien für einen flexiblen und dynamischen Raum:

Strategie per ottenere uno spazio flessibile e dinamico:

- Schaffen von Lichtatmosphären je nach vorgesehener Raumnutzung.
Creare atmosfere luminose in base all'uso che si vuole dare allo spazio.
- Anpassung des Lichts an den zirkadianen Rhythmus oder Tunable White um die Farbtemperatur an die Bedürfnisse und den Biorhythmus des Menschen anzupassen.
Adattare la luce in base al Ciclo circadiano o Tunable white, regolando la temperatura di colore in base alle necessità e a bioritmi delle persone.

Diese Strategien ermöglichen:

Queste strategie consentono di:

- Ein gesteigertes Wohlbefinden der Menschen.
Aumentare il benessere delle persone.
- Wecken von Gefühlen und Empfindungen.
Creare sensazioni ed emozioni.
- Weitaus flexiblere Räume.
Ottenere uno spazio molto più flessibile.

Wählen Sie die beste Option für Ihr Projekt aus
Scegli la soluzione più adatta al tuo progetto

Essential

- Standalone, Wifi oder Bluetooth
Standalone, Wifi o Bluetooth
- Statische Szenen und Wiedergabe von bewegten Szenen
Scene statiche e riproduzione di scene in movimento
- Farbbregelung der Leuchten mit den Optionen RGB oder RGBW
Controllo del colore in apparecchi con soluzioni RGB o RGBW
- Tunable White-Regelung
Regolazione Tunable White
- Uhrzeit- und Kalenderprogrammierungen
Programmazioni orarie e di calendario
- Fernbedienung der Anlage
Controllo remoto dell'impianto
- Kompatibilität mit Sprachassistenten
Compatibile con assistente vocale



Sevilla Fashion Outlet. Sevilla 2020.

Erforderliche Technologie / Tecnologia richiesta:
Light for Life oder Standalone / Light for Life o Standalone

Performance

- Standalone, Wifi oder Bluetooth
Standalone, Wifi o Bluetooth
- Statische Szenen und Wiedergabe von bewegten Szenen
Scene statiche e riproduzione di scene in movimento
- Farbbregelung der Leuchten mit den Optionen RGB oder RGBW
Controllo del colore in apparecchi con soluzioni RGB o RGBW
- Tunable White-Regelung
Regolazione Tunable White
- Uhrzeit- und Kalenderprogrammierungen
Programmazioni orarie e di calendario
- Fernbedienung der Anlage
Controllo remoto dell'impianto
- Individuelle zirkadiane Rhythmuskurve
Curva Ciclo Circadiano personalizzabile
- Belegungsabhängige Regelung
Regolazione in base all'occupazione
- Tageslichtabhängige Regelung
Regolazione in base al livello di luce naturale
- Integrierbar im DALI-System
Integrabile in Sistema DALI
- Integrierbar über API
Integrabile tramite API



Arts Buiding. London, 2020.
Fotografie / Fotografia: Ståle Eriksen

Erforderliche Technologie / Tecnologia richiesta:
Casambi oder DALI / Casambi o DALI

Farbmanagement Gestione del colore



Farbe ist das beste Mittel, um Emotionen zu vermitteln. Ein farbiger Raum kann Empfindungen auszulösen und den Menschen das Gefühl von Geborgenheit im Raum geben. Mit einer Lichtsteuerung von LEDS C4 bringen Sie Farbe und Flexibilität in die Räume, die zudem auf das jeweilige Kommunikationsziel oder den Anlagenkontext angepasst werden kann.

Il colore è il miglior mezzo per trasmettere emozioni. Uno spazio con colori è in grado di creare sensazioni e fare stare bene le persone che lo occupano. Dotare gli spazi di colore, li rende più flessibili, in grado di cambiare in base all'obiettivo di comunicazione o al contesto di installazione, e il tutto tramite un sistema di controllo della LEDS C4.

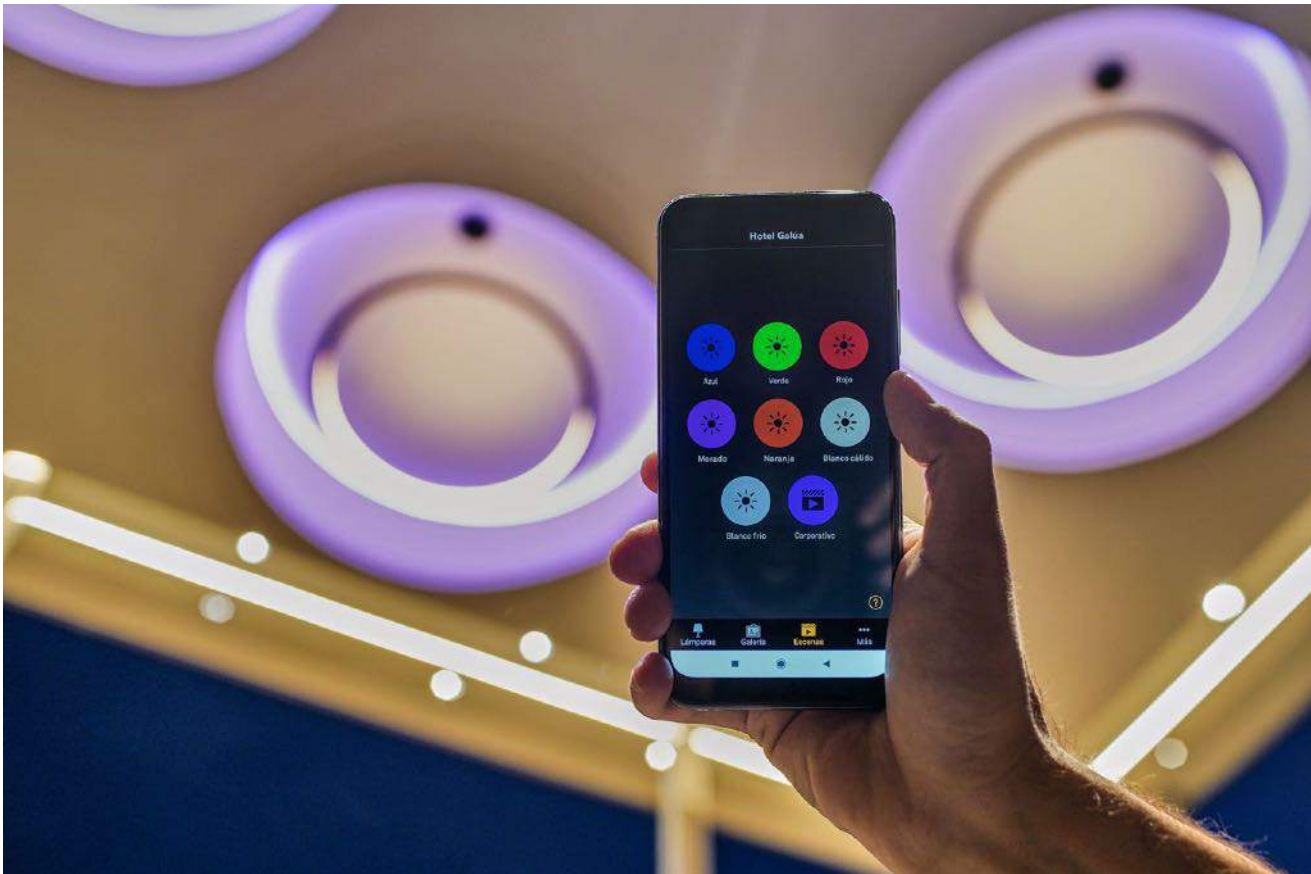

Hotel Galúa. Murcia 2021. Fotografía / Fotografia: Leafhopper

Wählen Sie die beste Option für Ihr Projekt aus
Scegli la soluzione più adatta al tuo progetto

Essential

- Farbregelung der Leuchten mit den Optionen RGB oder RGBW
Controllo del colore negli apparecchi con soluzioni RGB o RGBW
- Statische Szenen und Wiedergabe von bewegten Szenen
Scene statiche e riproduzione di scene in movimento

Erforderliche Technologie

Tecnologia richiesta:

Easy + Stand Alone



Banco Pichincha. Ecuador 2020

Fotografie / Fotografia: Diego Martínez - Zendero

Performance

- Farbregelung der Leuchten mit den Optionen RGB oder RGBW
Controllo del colore negli apparecchi con soluzioni RGB o RGBW
- Statische Szenen und Wiedergabe von bewegten Szenen
Scene statiche e riproduzione di scene in movimento
- Uhrzeit- und Kalenderprogrammierungen
Programmazioni orarie e di calendario
- Fernbedienung der Anlage
Controllo remoto dell'impianto

Erforderliche Technologie

Tecnologia richiesta:

Bluetooth Casambi oder DMX

Bluetooth Casambi o DMX



Urafiki. Festival Grec. Barcelona 2021

Fotografie / Fotografia: Jordi Anguera

Advanced

- Farbregelung der Leuchten mit den Optionen RGB oder RGBW
Controllo del colore negli apparecchi con soluzioni RGB o RGBW
- Statische Szenen und Wiedergabe von bewegten Szenen
Scene statiche e riproduzione di scene in movimento
- Uhrzeit- und Kalenderprogrammierungen
Programmazioni orarie e di calendario
- Fernbedienung der Anlage
Controllo remoto dell'impianto
- Präzise und individuelle Ansteuerung von Leuchten und LEDs
Controllo preciso e individuale di apparecchi e LED
- Video Mapping über die Leuchten
Video Mapping attraverso gli apparecchi
- Wechselwirkung von Licht und Umgebung
Interazione luce e ambiente

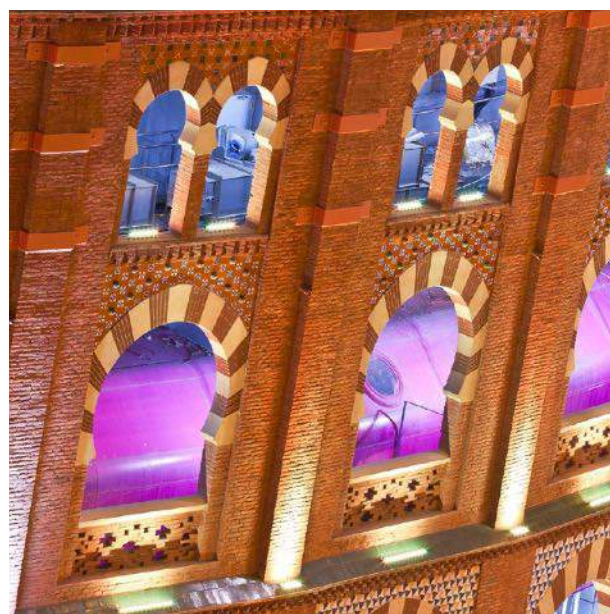

Las Arenas. Barcelona

Erforderliche Technologie / Tecnologia richiesta:

Digitale oder DMX-Steuerung / Controllo Digital o DMX

Energieeinsparung Risparmio energetico



Die Reduzierung des Energieverbrauchs wird durch die Kombination aus effizienter Beleuchtung und intelligenter Steuerung erreicht. Systeme, die Daten erfassen und Einsparstrategien auf Grundlage der Belegung und einer besseren Nutzung des natürlichen Lichts sowie der verfügbaren Ressourcen entwickeln.

La riduzione del consumo energetico è ottenuta grazie al binomio di illuminazione efficiente e sistema di controllo. Sistemi che consentono di raccogliere dati e stabilire strategie di risparmio basate sull'occupazione e un migliore sfruttamento della luce naturale e delle risorse disponibili.



Strategien zur Energieeinsparung:

Strategie di risparmio energetico:

- Regulierbare und auf die Erfordernisse von Personen oder Situationen anpassbare Beleuchtung. Einsparungen von bis zu 20 %.
Illuminazione regolabile e impostabile secondo le necessità della persona o della situazione. Fino al 20% di risparmio.
- Belegungssteuerung. Schalten verschiedener Regelstufen je nach Belegung oder Abwesenheit. Einsparungen von bis zu 30 %.
Controllo per occupazione Accensione di vari livelli di regolazione in funzione dell'occupazione o dell'assenza. Fino al 30% di risparmio.
- Regelung durch konstante Lichtsteuerung in Abhängigkeit vom Tageslichteinfall. Einsparungen von bis zu 30 %.
Regolazione tramite controllo costante della luce in funzione dell'ingresso di luce naturale. Fino al 30% di risparmio.

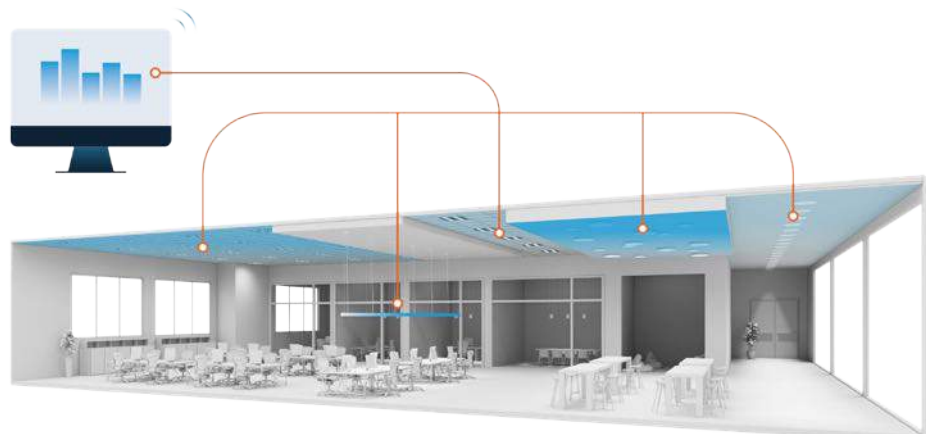

Wählen Sie die beste Option für Ihr Projekt aus
Scegli la soluzione più adatta al tuo progetto

Essential

- Belegungsabhängige Regelung
Regolazione in base all'occupazione
- Tageslichtabhängige Regelung
Regolazione in base al livello di luce naturale

Erforderliche Technologie
Tecnologia richiesta:
Standalone



Institut Vilablareix. Girona 2021.
Fotografie / Fotografia: Enric Badrinas

Performance

- Belegungsabhängige Regelung
Regolazione in base all'occupazione
- Tageslichtabhängige Regelung
Regolazione in base al livello di luce naturale
- Statische Szenen und Wiedergabe von bewegten Szenen
Scene statiche e riproduzione di scene in movimento
- Uhrzeit- und Kalenderprogrammierungen
Programmazioni orarie e di calendario
- Fernbedienung der Anlage
Controllo remoto dell'impianto
- BMS-Integration über BacNet
Integrabile BMS tramite BacNet
- Integration über API
Integrabile tramite API



CNTEC Girona. 2020
Fotografie / Fotografia: Jordi Anguera

Erforderliche Technologie / Tecnologia richiesta:
Bluetooth Casambi oder DALI / Bluetooth Casambi o DALI

Advanced

- Belegungsabhängige Regelung
Regolazione in base all'occupazione
- Tageslichtabhängige Regelung
Regolazione in base al livello di luce naturale
- Statische Szenen und Wiedergabe von bewegten Szenen
Scene statiche e riproduzione di scene in movimento
- Uhrzeit- und Kalenderprogrammierungen
Programmazioni orarie e di calendario
- Fernbedienung der Anlage
Controllo remoto dell'impianto
- BMS-Integration über BacNet
Integrabile BMS tramite BacNet
- Integration über API
Integrabile tramite API
- Erfassung von Belegungsdaten
Raccolta di dati sull'occupazione
- Vorbeugende Wartung
Manutenzione preventiva
- Energieeinspargrafiken
Grafici di risparmio energetico



Loom. Barcelona 2020
Fotografie / Fotografia: Jordi Anguera

Erforderliche Technologie / Tecnologia richiesta:
D4i

Raummanagement Gestione dello spazio

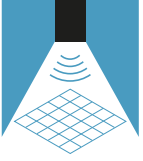

Um die Effizienz der Lichtinstallation und damit des Geschäfts zu steigern, ist ein sinnvolles Raummanagement unabdinglich.

Per aumentare l'efficienza di un impianto e così degli affari, è fondamentale gestire e controllare l'uso dello spazio.

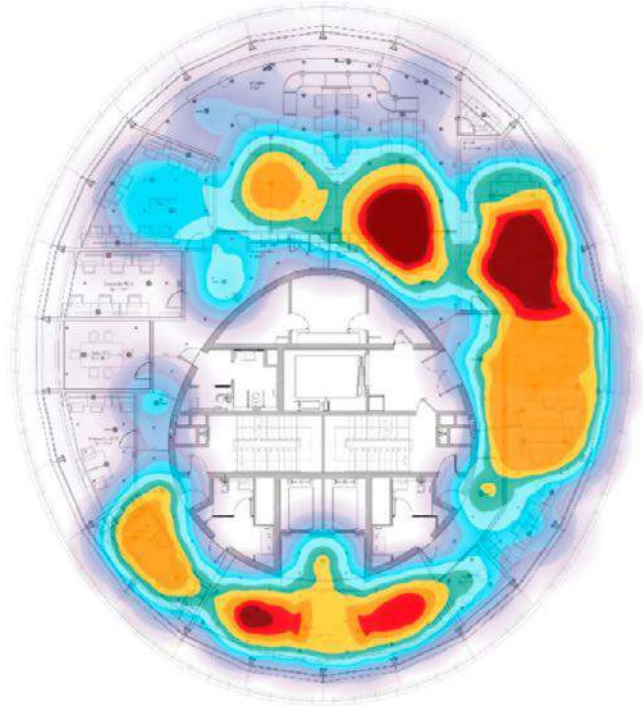

Strategien für ein sinnvolles Raummanagement:

Strategie per la gestione degli spazi:

- Erstellung von Heatmaps zur Ermittlung der am stärksten und am geringsten frequentierten Bereiche
Ottenerne mappe di calore per conoscere le zone più o meno transitate
- Visualisierung der am häufig genutzten Routen und der Nutzerbewegungen
Rendere visibili i percorsi più utilizzati e gli spostamenti degli utenti
- Kenntnis über die jeweilige Situation der Arbeitsplätze
Conoscere lo stato delle postazioni di lavoro

Diese Strategien ermöglichen:

Ces stratégies permettent de :

- Optimale Raumnutzung in der Organisation und Ermittlung des tatsächlichen Bedarfs
Sfruttare al massimo gli spazi di un'organizzazione e determinare le effettive necessità
- Kennenlernen der Nutzergewohnheiten
Conoscere le abitudini degli utenti
- Entwickeln von Aktionen oder Kommunikationsstrategien für die am stärksten frequentierten Bereiche.
Adottare campagne o strategie di comunicazione in funzione delle zone più transitate.

Wählen Sie die beste Option für Ihr Projekt aus
Scegli la soluzione più adatta al tuo progetto

Performance

- Statische Szenen und Wiedergabe von bewegten Szenen
Scene statiche e riproduzione di scene in movimento
- Belegungsabhängige Regelung
Regolazione in base all'occupazione
- Tageslichtabhängige Regelung
Regolazione in base al livello di luce naturale
- Tunable White-Regelung
Regolazione Tunable White
- Zirkadianer Rhythmus
Ciclo Circadiano
- Fernbedienung der Leuchten
Controllo remoto degli apparecchi
- Energieüberwachung
Monitoraggio dell'energia
- Vorbeugende Wartung
Manutenzione preventiva
- Erstellung von Heatmaps
Ottenimento di mappe di calore
- BMS-Integration über BacNet
Integrabile BMS tramite BacNet
- Integration über API
Integrabile tramite API



Oficinas LEDS C4. Lleida 2020
Fotografie / Fotografia: Nytt Studio

Erforderliche Technologie / Tecnologia richiesta:
D4i

Advanced

- Statische Szenen und Wiedergabe von bewegten Szenen
Scene statiche e riproduzione di scene in movimento
- Belegungsabhängige Regelung
Regolazione in base all'occupazione
- Tageslichtabhängige Regelung
Regolazione in base al livello di luce naturale
- Tunable White-Regelung
Regolazione Tunable White
- Zirkadianer Rhythmus
Ciclo Circadiano
- Fernbedienung der Leuchten
Controllo remoto degli apparecchi
- Energieüberwachung
Monitoraggio dell'energia
- Vorbeugende Wartung
Manutenzione preventiva
- Erstellung von Heatmaps
Ottenimento di mappe di calore
- BMS-Integration über BacNet
Integrabile BMS tramite BacNet
- Integration über API
Integrabile tramite API

Space-Service / Servizio Space:

- Nutzungswerte nach Zonen
Indice di utilizzo per zone
- Laufwegen der Nutzer
Percorsi di spostamento degli utenti

Where-Service / Servizio Where:

- Identifizierung und Ortung von Anlagenegegenständen
Servizio di identificazione e ubicazione di attivi

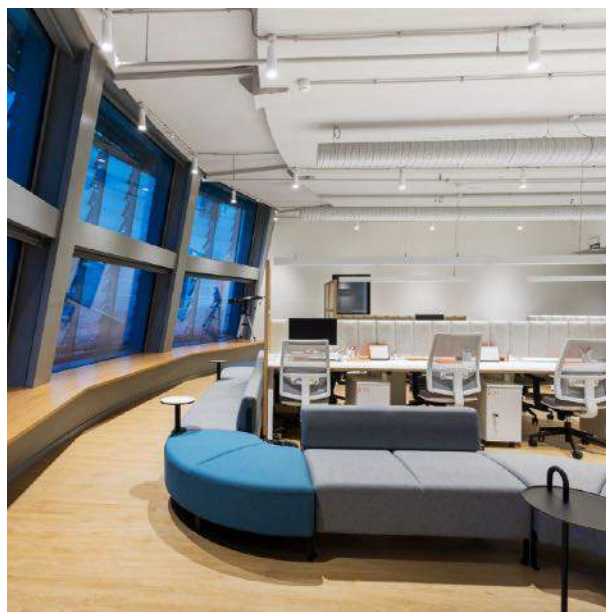

Loom. Barcelona 2020
Fotografie / Fotografia: Jordi Anguera

Erforderliche Technologie / Tecnologia richiesta:
D4i + Space Service + Where Service
D4i + Space Service + Where Service

Vorbeugende Wartung Manutenzione preventiva

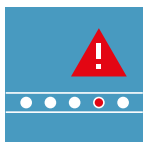

Durch die aktive Überwachung der von den Leuchten übermittelten Informationen ist der Zustand und die Lebensdauer der Leuchtmittel abrufbar, Störungen können erkannt und die Geräte und Anlagen überprüft werden, um den ordnungsgemäßen Betrieb und die Instandhaltung dauerhaft zu gewährleisten.

Un follow-up attivo delle informazioni ottenute dagli apparecchi ci consente di conoscere lo stato e la durata degli apparecchi, rilevare problemi e realizzare revisioni dei dispositivi e degli impianti, per garantire un buon funzionamento e la futura conservazione.

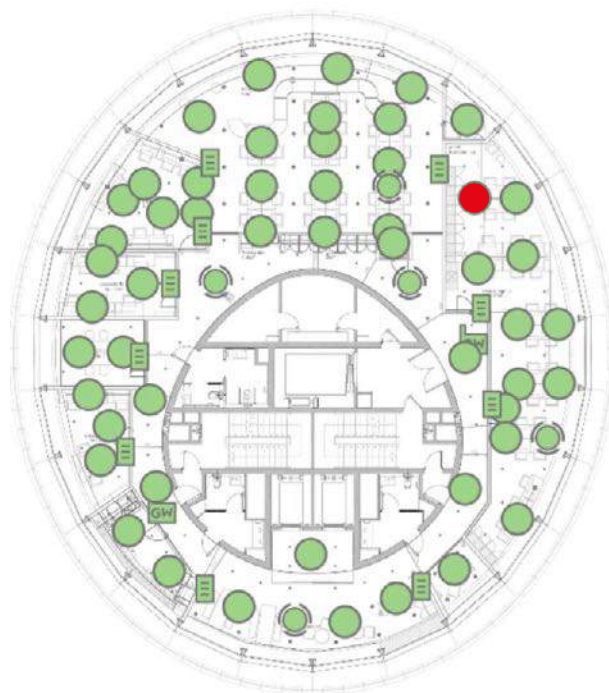

Wählen Sie die beste Option für Ihr Projekt aus
Scegli la soluzione più adatta al tuo progetto

Performance

- Überprüfung des Zustands der Leuchten
Verifica dello stato degli apparecchi
- Überprüfung der Geräte und Sensoren
Verifica di dispositivi e sensori
- Überprüfung des Zustands der Notleuchten
Revisione dello stato degli apparecchi di emergenza
- Sicherungskopie des Systems
Copia di sicurezza dell'impianto

Erforderliche Technologie
Tecnologia richiesta:
DALI oder Casambi / DALI o Casambi



CNTEC. Girona 2019
Loom. Barcelona 2020
Fotografie / Fotografia: Jordi Anguera

Advanced

- Überprüfung des Zustands der Leuchten
Verifica dello stato degli apparecchi
- Überprüfung der Geräte und Sensoren
Verifica di dispositivi e sensori
- Überprüfung des Zustands der Notleuchten
Revisione dello stato degli apparecchi di emergenza
- Sicherungskopie des Systems
Copia di sicurezza dell'impianto
- Alarmmeldungen bei Funktionsstörungen
Lancio di allarmi di funzionamento anomalo
- Kontrolle der Drivertemperatur
Conoscenza della temperatura dei driver
- Übersicht über die Betriebsstunden und den Verbrauch der Leuchten
Riassunto delle ore di funzionamento di apparecchi e loro consumo

Erforderliche Technologie
Tecnologia richiesta:
D4i



Loom. Barcelona 2020
Fotografie / Fotografia: Jordi Anguera

Beratung und Inbetriebnahme

Servizi di assistenza e messa in funzione

Mit unserem Inbetriebnahmeservice machen wir Ihre Vorstellungen von Beleuchtung, Regelung und Konnektivität schnell und einfach wahr.

Trasforma in realtà le tue idee di illuminazione, controllo e connettività in modo facile e rapido grazie ai servizi di messa in funzione.

Ready-to-Leistungen Servizi Ready to

Video
ansehen
Guarda
il video



Ready to use

Dieser Service beinhaltet eine grundlegende Werkskonfiguration zur Identifikation von Leuchten und Geräten.

Servizio che include la configurazione di base di fabbrica di identificazione di apparecchi e dispositivi.

Ready to play

Umfassender Werkskonfigurations-Service für alle Lichtfunktionen des Projekts: Lichtszenen, Zeitprogrammierungen, Sensoren und vieles mehr.

Servizio di configurazione totale di fabbrica, che include tutte le funzionalità illuminotecniche del progetto: scene luminose, programmazioni orarie, sensori e molto altro.



Anfrage für die persönlichen
Bedürfnisse Ihres Raums
Richiesta di esigenze
personalizzate del tuo spazio



Ready to Use
Programmierung und
Inbetriebnahme von
Geräten im Werk

Programmazione e messa
in servizio dei dispositivi
in fabbrica

Ready to Play
Programmierung von
Szenen, Zeitplänen,
zirkadianem Zyklus usw

Programmazione delle
scene, programmazioni
orarie, ciclo circadiano...



Einsatzberatung per Videokonferenz
Consulenza operativa mediante
videoconferenza



App herunterladen. Steuern Sie Ihren
Raum und haben Sie Spaß daran
Scarica App. Accedi al controllo del
tuo spazio e divertiti

On Site-Service Servizio On Site

Dieser Service umfasst die Beratung und Inbetriebnahme vor Ort. Installation der Leuchten nicht inbegriffen.

Servizio che include l'assistenza e la consulenza in presenza in cantiere.

Installazione degli apparecchi di illuminazione non inclusa.



Digitale Dienste

Servizi digitali

Mehrwert für Ihr Projekt durch digitale Funktionen
Apporta un valore aggiunto al tuo progetto grazie alle funzionalità digitali

Energieüberwachung

Monitoraggio energia

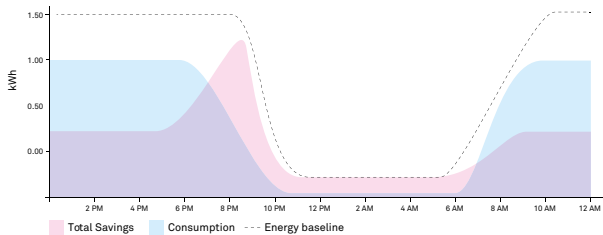

Dieser Dienst ermöglicht die Visualisierung von Daten zum Energiemanagement der Anlage, eine verbesserte Datenanalyse und die Entwicklung von Strategien zur Effizienzsteigerung. Enthalten sind:

Servizio che consente di visualizzare informazioni relative alla gestione energetica dell'impianto, migliorare l'analisi dei dati e adottare strategie che migliorino l'efficienza. Include:

- Beobachtung des Energieverbrauchs der Anlage über einen bestimmten Zeitraum hinweg.
Consente di osservare il consumo dell'impianto secondo un periodo di tempo determinato.
- Visualisierung der Einschaltzeiten einer Leuchte
Visualizzare le ore di accensione di un apparecchio

Raummanagement, Space-Service

Gestione spazi, servizio Space



Dieser Dienst ermöglicht eine ausführliche und präzise Visualisierung der Raumnutzungswerte nach Aufenthaltszeit oder untersuchtem Bereich. Erstellung von Berichten für eine verbesserte Analyse und besseres Datenverständnis. Enthalten sind:

Servizio che consente di visualizzare in maniera dettagliata e precisa gli indici di utilizzo dello spazio, analizzati in base al tempo di occupazione o alla zona esaminata. Creazione di report per una migliore analisi e comprensione dei dati. Include:

- Heatmaps
Mappe di calore
- Häufig genutzte Routen
Percorsi d'uso
- Ausführlicher Raumnutzungsbericht
Report dettagliato di uso dello spazio
- Genaue Erkennung durch Belegungssensoren nach Untersuchungszeitraum
Rilevamento preciso di sensori di presenza in funzione del periodo da analizzare

Objektverfolgung, Where-Service

Inseguimento di oggetti, servizio Where

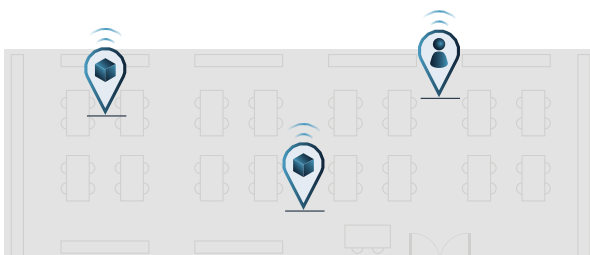









Dieser Service ermöglicht es, den Standort eines Anlagegegenstandes schnell und genau zu bestimmen, Warnmeldungen je nach Standort zu generieren oder einen Anlagegegenstand schnell zu identifizieren. Enthalten sind:

Servizio che consente di analizzare l'ubicazione di attivi in modo preciso, di lanciare allarmi in funzione dell'ubicazione o di identificare un attivo in modo rapido. Include:

- Visualisierung der Route und des Standorts von Objekten
Visualizzazione del percorso e ubicazione degli oggetti
- Alarmmanagement entsprechend der Bereiche mit Zugangsverbot
Gestione di allarmi in funzione di zone ad accesso vietato d'accesso

INDOOR

 <p>Modulare Systeme Sistemi modulari</p> <p>039</p>	 <p>Strahler Proiettori</p> <p>071</p>	<p>LV</p> <p>Niederspannung Bassa tensione</p> <p>121</p>	 <p>Downlights Downlights</p> <p>157</p>	 <p>Pendelleuchten Sospensioni</p> <p>295</p>
 <p>Wandleuchten /Deckenleuchten Lampade da parete /Plafoniere</p> <p>305</p>	 <p>Module Moduli</p> <p>327</p>	 <p>Signalisierung Segnaletica</p> <p>331</p>	 <p>Lineare Beleuchtungssysteme Sistemi lineari d'illuminazione</p> <p>343</p>	 <p>LED-Bänder Strisce LED</p> <p>413</p>



Modulare Systeme

Sistemi modulari



Iris

041

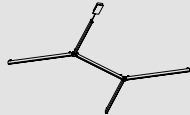

Apex

053



Iris

Spotlights

P. 047



Recessed Trim



Recessed Trimless



Surface



3-Phase Track

Low voltage

P. 049



Low voltage Track

Pendants

P. 050



Recessed Trim



Recessed Trimless



Recessed Surface

Wall fixtures/Ceilings

P. 051



Surface



Surface

Komponenten / Componenti



Hoop



Visual Comfort



Pipe



Cone



Glass

Iris

SUMMALAB 2022

BODY MAT		50000h	2
AL		L80 B20	MacAdam



Abzweigungen von einer perfekten Struktur Ramificazione da una struttura perfetta

Licht und Atmosphäre sprechen die gleiche Sprache. Nichts ist unmöglich für Iris, denn das System lässt sich in der exakten Form an der richtigen Stelle im Raum einpassen. Unendliche Kombinationsmöglichkeiten und die beispiellose Regelbarkeit der Lichtquelle sind die Unterscheidungsmerkmale dieser Kollektion, die hohes technisches Niveau in einer Hülle mit ausgeprägt dekorativem Charakter bietet.

Luce e ambiente che parlano la stessa lingua. Niente è impossibile per Iris, in quanto riesce a integrarsi negli spazi adottando la forma giusta nel luogo giusto. Le infinite possibilità di combinazione e la modularità della sorgente luminosa sono gli elementi distintivi di questa collezione, che offre un'elevata tecnicità in un corpo dal forte carattere decorativo.

Die Iris ist der ringförmige Kern des Auges, der den Lichteinfall reguliert und von dem aus sich die verschiedenen Fasern verzweigen und zu einer perfekten Struktur zusammenfügen, die es uns ermöglicht, Licht zu verarbeiten. Nach diesem Konzept entstand Iris, eine Leuchte, deren Hauptbestandteil ein Kern ist, der in zwei Größen und mit ausgeklügelten Optiken in verschiedenen Leistungsstufen erhältlich ist. Von diesem Kern ausgehend entstehen wie in einem unendlichen Gestaltungsspiel die Verästelungen der möglichen Kompositionen, die sich dem Raum dynamisch und flexibel anpassen.

L'iride è il nucleo circolare dell'occhio che controlla l'ingresso della luce e da cui si diramano le diverse fibre che lavorano insieme per formare una struttura perfetta, che ci permette di elaborare la luce. Questo è il concetto su cui è stato concepito Iris, un apparecchio di illuminazione la cui base principale è un nucleo con due dimensioni disponibili e un'ottica elaborata di diverse potenze. Da quel nucleo e, come se fosse un infinito gioco compositivo, emergono le ramificazioni delle sue possibili composizioni, per adattarsi allo spazio in modo elastico e flessibile.



2 Module mit verschiedenen Leistungen

2 moduli con varie potenze

Iris umfasst 2 Module mit verschiedenen Leistungen (6 W / 12 W / 18 W) zur Anpassung an die Projektanforderungen. Die Module können mit den verschiedenen Anwendungen der Kollektion und allen Diffusor-Optionen kombiniert werden.

Iris offre 2 moduli con varie potenze (6W / 12W / 18 W) per adattarsi alle esigenze del progetto. I moduli sono combinabili con le applicazioni possibili della collezione e con tutti i modelli di diffusori.



18W

12W

6W

Polycarbonatlinse

Lente in policarbonato

Die Basis der Produktfamilie Iris enthält eine Polycarbonat-Linse mit 3 verschiedenen Öffnungen, um das Licht ohne Abweichungen scharf und präzise projizieren zu können.

Il nucleo di Iris integra una lente in policarbonato con 3 diverse aperture in grado di proiettare la luce senza aberrazioni, in modo chiaro e preciso.



Maximale Vielseitigkeit Massima versatilità

Die Vorstellungskraft des Designers sollte bei der Gestaltung und Beleuchtung eines Raumes die einzige Grenze sein. Das ist das Ziel dieser kompakten Kollektion, die vor allem durch ihre Vielseitigkeit besticht. Iris kann dank der Kombination aus 9 Sockeln und 5 Diffusoren für verschiedene Anwendungen zusammengestellt werden: Pendelleuchte, Strahler (Dreileiter oder Niedervolt), Wand- oder Deckenleuchte, Auf- oder Unterputz, mit oder ohne Rahmen.

Che l'immaginazione di chi lo disegna sia l'unico limite nella composizione e nell'illuminazione di uno spazio. Ecco l'obiettivo di questa collezione compatta, lavorata pensando alla versatilità come una delle sue massime qualità. Iris può essere composta con varie applicazioni: a sospensione, proiettore (3 Phase o Low Voltage) e a parete/soffitto, con opzioni Surface, recessed, con cornice o senza cornice, grazie alla combinazione di 9 basi e 5 diffusori.



Ein Licht für jeden Augenblick Una luce per ogni momento

In allen Ausführungen ist Iris mit 5 verschiedenen Diffusoren erhältlich, mit denen die Silhouette und die Wahrnehmung der Leuchte verändert und an die Anforderungen jedes Projekts angepasst werden können. Die kegelförmigen, ovalen und zylindrischen Glasschirme sind ideal für eher dekorative Projekte, während die Ring- und Visual Comfort-Optionen besser zu technischen Umgebungen passen.

In tutte le sue versioni Iris offre la possibilità di scegliere tra 5 diffusori che cambiano la sagoma e la percezione della lampada, adattandola così alle esigenze di ogni progetto. Gli schermi di vetro, di forma conica, ovale e cilindrica, sono ideali per progetti più decorativi, mentre le opzioni anello e Comfort Visual sono perfette per ambienti più tecnici.

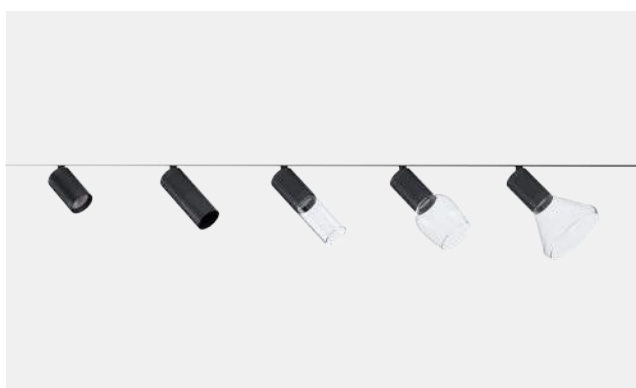

Vielfältiges Zubehör Varietà di accessori

Die Diffusor-Optionen können mit 5 Zubehörteilen ergänzt werden, die das Licht entweder auf einen Punkt fokussieren oder streuen, um eine homogenere Raumwirkung zu erzielen. Bei den Ausführungen ohne Glasdiffusor können alle Zubehörteile außer dem Ring eingesetzt werden.

Le opzioni di diffusore possono essere completate da 5 accessori, che modulano la luce o per focalizzarla su un punto o per sfumarla e ottenere un effetto più omogeneo nello spazio. Nelle opzioni senza diffusore di vetro è possibile usare tutti gli accessori tranne l'anello.



Modellierbares Licht Luz modelable

Ein und derselbe Raum kann sehr unterschiedliche Beleuchtungsansprüche stellen, denen mit modularen Kollektionen begegnet werden kann, die trotz gemeinsamer Gestaltungssprache mit unabhängigen Merkmalen konfigurierbar sind. Iris ist die Antwort auf diese Ansprüche. Der stark modulare Charakter der drei Steuerungselemente Linse, Schirm und Zubehör macht sie zur ersten Wahl für die Schaffung eines segmentierten und doch im Gesamtbild homogenen, ganz eigenen Stils.

In uno stesso spazio possono convivere esigenze di illuminazione molto diverse, che richiedono collezioni modulari che, pur parlando una stessa lingua, possano essere configurate con caratteristiche indipendenti. Iris è la risposta a questa necessità. L'elevata modularità dei suoi tre punti di controllo (lente, schermo e accessori) la trasforma nella scelta perfetta per ottenere uno stile giusto per segmenti e omogeneo nell'insieme.

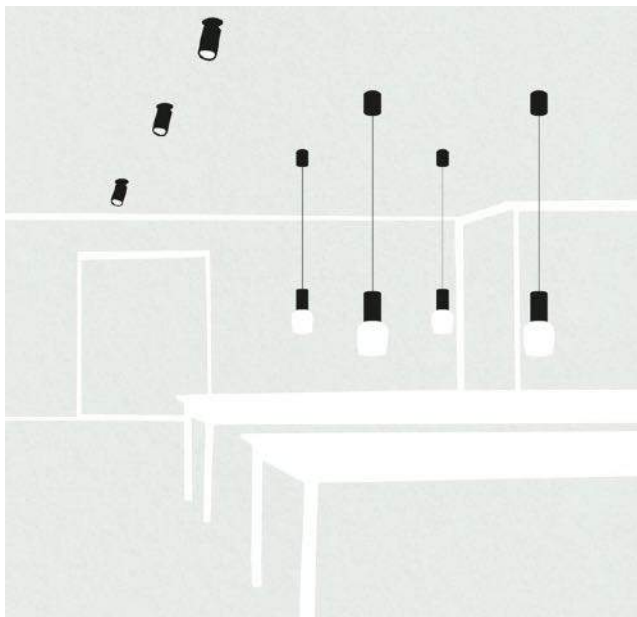
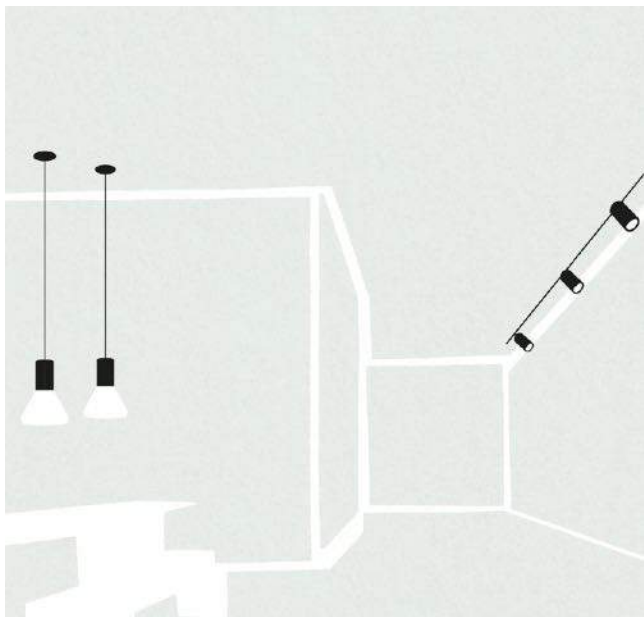

Online-Konfigurator Configuratore online



Konfigurieren Sie Ihre Leuchte
Configura il tuo apparecchio

Mit dem Online-Konfigurator von LEDES C4 lassen sich auf praktische und effektive Weise Leuchten zusammenstellen, die ganz auf das jeweilige Projekt zugeschnitten sind.

Grazie allo strumento di configurazione online di LEDES C4 è possibile creare, in modo pratico ed efficace, un apparecchio di illuminazione completamente adattato ad ogni progetto.

iris.leds-c4.com



1. Beleuchtungskonfiguration (Auswahl: Installation, Leistung, Diffusor, Zubehör, Farbtemperatur, Optik, Dimmung)
Configurazione dell'apparecchio (selezione: installazione, potenza, diffusore, accessorio, temperatura di colore, ottica, regolazione)

2. Dokumentation herunterladen
Scaricare documentazione

IRIS Spotlight



Codebeispiel / Esempio di codice: AV11-P6V9U10S60

Model	W	K/ CRI/ Real lm	Shade	Optics	Source	Finishes
 <p>AV11 - Strahler / Mit Rahmen Proiettori / Trim ⌀ 57</p> <p>Ø55</p> <p>Max. 120</p> 	P6 6W	V9 2700K/CRI90/ 692 lm	U Hoop	1 15°	OS ON-OFF/ 220-240V/ 50-60Hz DS DALI-2/ 110-277V/ 50-60Hz	60 ●
		W9 3000K/CRI90/ 692 lm	V Visual Comfort	2 35°		
		X9 4000K/CRI90/ 695 lm	X Cone	3 50°		
	12 12W	V9 2700K/CRI90/ 1181 lm	Y Glass			
		W9 3000K/CRI90/ 1181 lm	Z Pipe			
		X9 4000K/CRI90/ 1181 lm				
 <p>AV12 - Strahler / Randlos Proiettori / Trimless ⌀ 57</p> <p>Ø55</p> <p>Max. 120</p> 	18 18W	V9 2700K/CRI90/ 1325 lm				
		W9 3000K/CRI90/ 1325 lm				
		X9 4000K/CRI90/ 1325 lm				
 <p>AV13 - Strahler / Deckenleuchten Proiettori / Plafoniere</p> <p>Ø69</p> <p>Max. 150</p> 						



Hoop

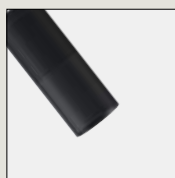

Visual Comfort



Cone



Glass



Pipe



nicht inklusive / Non incluso

Wabenraster x 5 / Pannello a nido d'ape (5 unità)	71-5166-60-00
Elliptischer Diffusor x 5 / Diffusore ellittico (5 unità)	71-5167-00-00
5Weichzeichnerlinse x 5 / Sagomatore di fascio (5 unità)	71-6099-00-00
Schirm x 5 / Screen x 5	71-7894-60-00
Quadratischer Diffusor x 5 / Diffusore quadrato (5 unità)	71-5658-00-00

IRIS Track

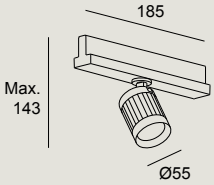

Codebeispiel / Esempio di codice: AV21-P6V9U10S60

Model	W	K/ CRI/ Real lm	Shade	Optics	Source	Finishes	
 	P6 6W	V9 2700K/CRI90/ 692 lm	U Hoop	1 15°	OS  ON-OFF/ 220-240V/ 50-60Hz	60 ●	
		W9 3000K/CRI90/ 692 lm	V Visual Comfort	2 35°			DS  DALI-2/ 220-240V/ 50-60Hz
		X9 4000K/CRI90/ 695 lm	X Cone	3 50°			
	12 12W	V9 2700K/CRI90/ 1181 lm	Y Glass				
		W9 3000K/CRI90/ 1181 lm	Z Pipe				
		X9 4000K/CRI90/ 1181 lm					
	18 18W	V9 2700K/CRI90/ 1325 lm					
		W9 3000K/CRI90/ 1325 lm					
		X9 4000K/CRI90/ 1325 lm					

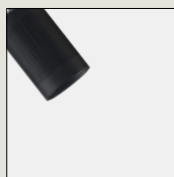

Hoop



Visual Comfort



Cone



Glass



Pipe

nicht inklusive / Non incluso



Wabenraster x 5 / Pannello a nido d'ape (5 unità)	71-5166-60-00
Elliptischer Diffusor x 5 / Diffusore ellittico (5 unità)	71-5167-00-00
5Weichzeichnerlinse x 5 / Sagomatore di fascio (5 unità)	71-6099-00-00
Schirm x 5 / Screen x 5	71-7894-60-00
Quadratischer Diffusor x 5 / Diffusore quadrato (5 unità)	71-5658-00-00

IRIS

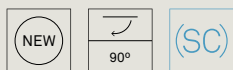
Low Voltage

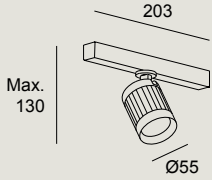

Codebeispiel / Esempio di codice: AV19-P6V9U10S60

Model	W	K/ CRI/ Real lm	Shade	Optics	Source	Finishes	
 	P6 6W	V9 2700K/CRI90/ 692 lm	U Hoop	1 15°	OS  ON-OFF/ 48 VDC	60 ●	
		W9 3000K/CRI90/ 692 lm	V Visual Comfort	2 35°	DS  DALI/ 48 VDC		
		X9 4000K/CRI90/ 695 lm	X Cone	3 50°			
	12 12W	V9 2700K/CRI90/ 1181 lm	Y Glass				
		W9 3000K/CRI90/ 1181 lm	Z Pipe				
		X9 4000K/CRI90/ 1181 lm					
	18 18W	V9 2700K/CRI90/ 1325 lm					
		W9 3000K/CRI90/ 1325 lm					
		X9 4000K/CRI90/ 1325 lm					

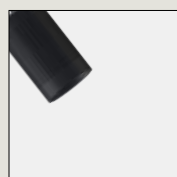

Hoop

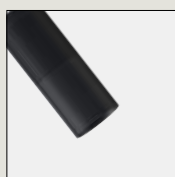

Visual Comfort



Cone



Glass



Pipe

nicht inklusive / Non incluso

Wabenraster x 5 / Pannello a nido d'ape (5 unità)	71-5166-60-00
Elliptischer Diffusor x 5 / Diffusore ellittico (5 unità)	71-5167-00-00
5Weichzeichnerlinse x 5 / Sagomatore di fascio (5 unità)	71-6099-00-00
Schirm x 5 / Screen x 5	71-7894-60-00
Quadratischer Diffusor x 5 / Diffusore quadrato (5 unità)	71-5658-00-00

Smart Compatible-Zub. / Access. Smart Compatibile

71-8115-00-00 Dimmer DALI Casambi



Codebeispiel / Esempio di codice: AV14-P6V9U10S60

Model	W	K/ CRI/ Real lm	Shade	Optics	Source	Finishes	
 <p>AV14 - Pendelleuchten / Mit Rahmen Sospensioni / Trim ① 57</p> 	P6 6W	V9 2700K/ CRI90/692 lm	U Hoop	1 15°	OS  ON-OFF/ 220-240V/ 50-60Hz DS  DALI-2/ 110-277V/ 50-60Hz	60 ●	
		W9 3000K/ CRI90/ 692 lm	V Visual Comfort	2 35°			
		X9 4000K/ CRI90/ 695 lm	X Cone	3 50°			
	12 12W	V9 2700K/ CRI90/ 1181 lm	Y Glass				
		W9 3000K/ CRI90/ 1181 lm	Z Pipe				
		X9 4000K/ CRI90/ 1181 lm					
 <p>AV15 - Pendelleuchten / Randlos Sospensioni / Trimless ① 57</p> 	18 18W	V9 22700K/ CRI90/ 1325 lm					
		W9 3000K/ CRI90/ 1325 lm					
		X9 4000K/ CRI90/ 1325 lm					
 <p>AV16 - Pendelleuchten / Aufputz Sospensioni / Superficie</p> 							

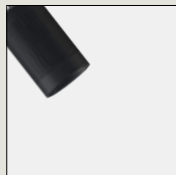

Hoop



Visual Comfort



Cone



Glass



Pipe





nicht inklusive / Non incluso	
Wabenraaster x 5 / Pannello a nido d'ape (5 unità)	71-5166-60-00
Elliptischer Diffusor x 5 / Diffusore ellittico (5 unità)	71-5167-00-00
5Weichzeichnerlinse x 5 / Sagomatore di fascio (5 unità)	71-6099-00-00
Schirm x 5 / Screen x 5	71-7894-60-00
Quadratischer Diffusor x 5 / Diffusore quadrato (5 unità)	71-5658-00-00

IRIS

Ceiling

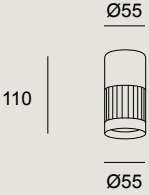

Codebeispiel / Esempio di codice: AV17-P6V9U10S60

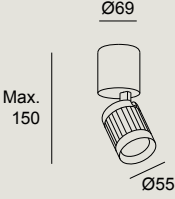
Model	W	K/ CRI/ Real lm	Shade	Optics	Source	Finishes	
 <p>AV17 - Deckenleuchten / Fest Plafoniere / Fisso</p> 	P6 6W	V9 2700K/CRI90/ 692 lm	U Hoop	1 15°	OS  ON-OFF/ 220-240V/ 50-60Hz	60 ●	
		W9 3000K/CRI90/ 692 lm	V Visual Comfort	2 35°			DS  DALI-2/ 110-277V/ 50-60Hz
		X9 4000K/CRI90/ 695 lm	X Cone	3 50°			
	12 12W	V9 2700K/CRI90/ 1181 lm	Y Glass				
		W9 3000K/CRI90/ 1181 lm	Z Pipe				
		X9 4000K/CRI90/ 1181 lm					
 <p>AV13 - Deckenleuchten / Strahler Plafoniere / Proiettori</p> 	18 18W	V9 2700K/CRI90/ 1325 lm					
		W9 3000K/CRI90/ 1325 lm					
		X9 4000K/CRI90/ 1325 lm					

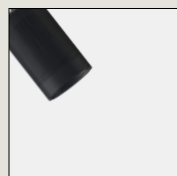

Hoop



Visual Comfort



Cone



Glass



Pipe

nicht inklusive / Non incluso

Wabenraster x 5 / Pannello a nido d'ape (5 unità)	71-5166-60-00
Elliptischer Diffusor x 5 / Diffusore ellittico (5 unità)	71-5167-00-00
5Weichzeichnerlinse x 5 / Sagomatore di fascio (5 unità)	71-6099-00-00
Schirm x 5 / Screen x 5	71-7894-60-00
Quadratischer Diffusor x 5 / Diffusore quadrato (5 unità)	71-5658-00-00



Apex

BODY MAT		50000h
AL		L80 B20

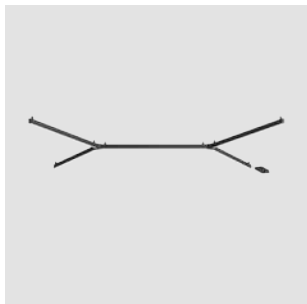

Räume kommunizieren durch die Komposition ihrer Elemente. Apex ist eine lineare Lösung, die sich durch ihrer hohe Kompositionsfähigkeit und vielfältige Anwendungsmöglichkeiten an diverse Raumgestaltungen anpasst. Die Aufbauten können recht einfach sein und mit einer einzigen Lichtquelle auskommen, oder durch Verkettung des Leuchtensystems verschiedene geometrische Figuren bilden.

Gli spazi comunicano attraverso la composizione dei suoi elementi. Apex è una soluzione lineare che si adatta a vari ambienti, grazie alla sua capacità compositiva e alla diversità delle sue applicazioni. Le sue costruzioni possono essere semplici, con un'unica sorgente luminosa, o complesse, con figure geometriche formate dalla concatenazione del suo sistema.



Konstruktive Elemente Elementi costruttivi

Apex besteht aus einem Profil in schwarzer oder weißer Ausführung sowie verschiedenen Knotenpunkten, mit denen der Designer Strukturen erstellen kann, die für jeden Bedarf das richtige Lichtmuster bieten. Die Profile können sowohl linear (1, 2 und 3 Meter lang) oder auch bogenförmig sein. Die Knotenpunkte sind mit 4 bzw. 6 Steckverbindungen erhältlich, womit die Profile in den gewünschten Formen zusammengesetzt werden können.

Apex si configura attraverso un profilo, disponibile nei colori bianco e nero, e vari nodi per comporre strutture che consentono al progettista di creare diversi modelli per ogni necessità. Da una parte, il profilo può essere lineare (nelle lunghezze 1, 2 e 3 metri) o a forma di arco. Dall'altra, Apex dispone di vari nodi con strutture fino a 4 e 6 incastri che uniscono i profili per ottenere le forme desiderate.

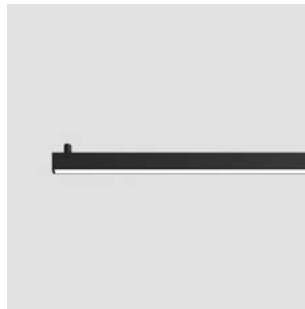

Gerades Profil
Profilo lineare



Kreisprofil
Profilo ad arco

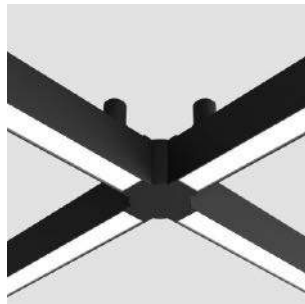

4er Kreuz
Nodo a 4

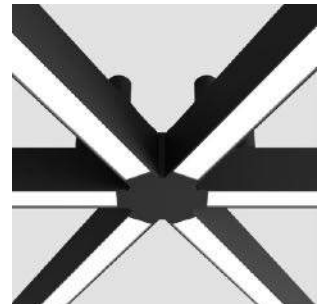

6er Kreuz
Nodo a 6

Die richtige Optik für jeden Bedarf Un'ottica per ogni esigenza

Die linearen Optionen verfügen über Opal-Optiken für diffuses Licht mit einem UGR > 16, ideal für Arbeitsräume, und Bento mit einem kontrollierten Öffnungswinkel von 52° sowie eine Spot-Option zur Fokussierung des Lichts. Die Arco-Option verfügt über eine Opal-Optik.

Le opzioni lineari dispongono di ottiche Opal per ottenere una luce diffusa con un UGR>16, ideale per spazi di lavoro, Bento, con un angolo controllato di apertura di 52° e un'opzione Spot per focalizzare la luce. L'opzione Arco dispone di ottica Opal.

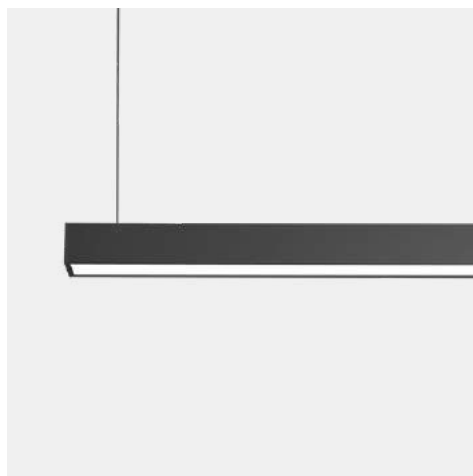

Opal (UGR>16)

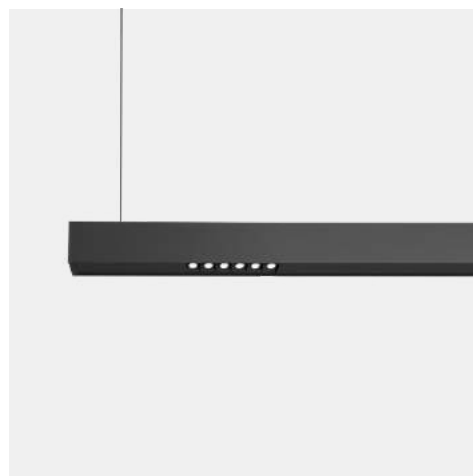

Bento (UGR>16)



Spot

Installation und Vielseitigkeit Installazione e versatilità

Apex kann je nach den Projektanforderungen und dem zu gestaltenden Raumumfeld im Auf- oder hängend installiert werden. Bei beiden Einbaumöglichkeiten sind die Knotenpunkte die Schlüsselemente, um entweder in der Standardoption oder mit unserem Online-Konfigurator die gewünschten Formen zu bilden.

Apex può essere sospesa o installata in superficie, in base alle esigenze del progetto e del tipo di ambiente da lavorare. In entrambi i casi, i nodi agiscono da elemento chiave per ottenere le forme desiderate, sia in opzioni standard che nelle soluzioni ottenute con il nostro configuratore online.

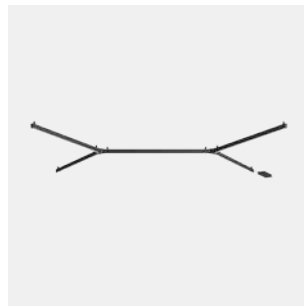
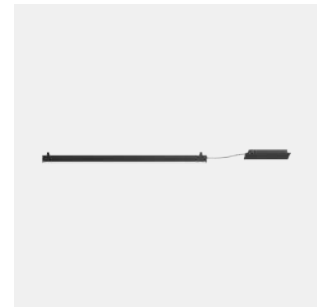
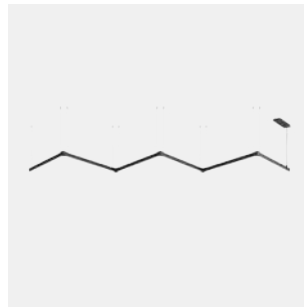
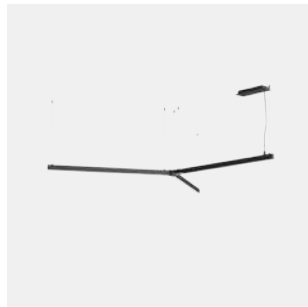
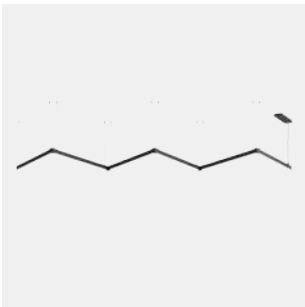
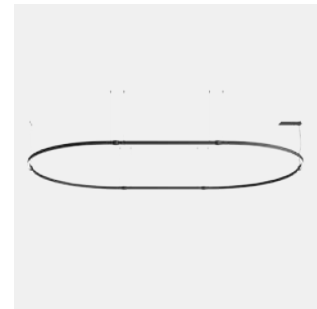
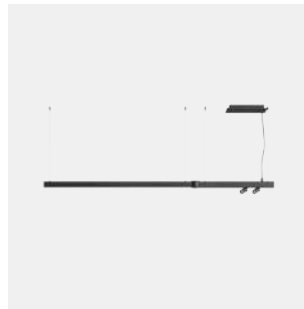
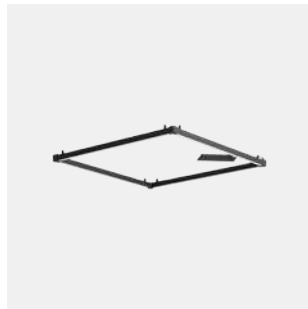
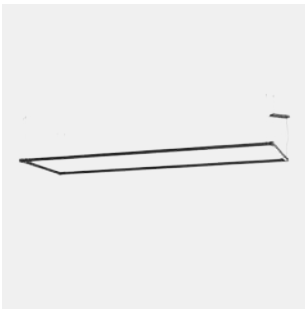

Smart

Apex EX ist in Versionen mit eingebauter Casambi Bluetooth Mesh-Technologie erhältlich, um Räume mit wechselnden Anforderungen flexibel zu gestalten.

Apex dispone di versioni con tecnologia Casambi Bluetooth Mesh incorporata, il che consente di aumentare la flessibilità degli spazi in ambienti con esigenze mutevoli.

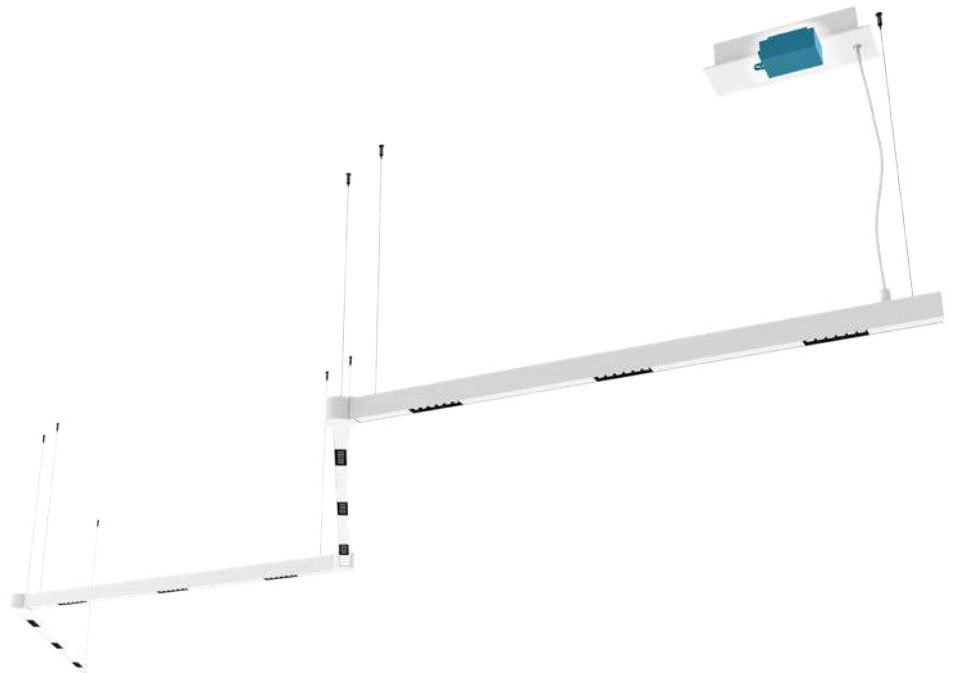

Smart-Funktionen: Lichtatmosphären Funzionalità Smart: Atmosfere luminose

Als eine der Funktionalitäten der Smart-Technologie des modularen Apex-Systems besteht die Möglichkeit, die Lichtstärke je nach Raumnutzung und momentanem Ausleuchtungsbedarf zu regulieren und so mehr Flexibilität und Dynamik zu bieten.

Una delle funzionalità della tecnologia Smart nel sistema modulare Apex consiste nella possibilità di regolare il livello luminoso in base all'uso dello spazio e alle esigenze luminose di ciascun momento, offrendo così una maggiore flessibilità e più dinamismo.



Online-Konfigurator Configuratore online



Konfigurieren Sie Ihre Leuchte
Configura il tuo apparecchio

Mit dem Online-Konfigurator von LEDS C4 lassen sich auf praktische und effektive Weise Leuchten zusammenstellen, die ganz auf das jeweilige Projekt zugeschnitten sind. Grazie allo strumento di configurazione online di LEDS C4 è possibile creare, in modo pratico ed efficace, un apparecchio di illuminazione completamente adattato ad ogni progetto.

apex.leds-c4.com

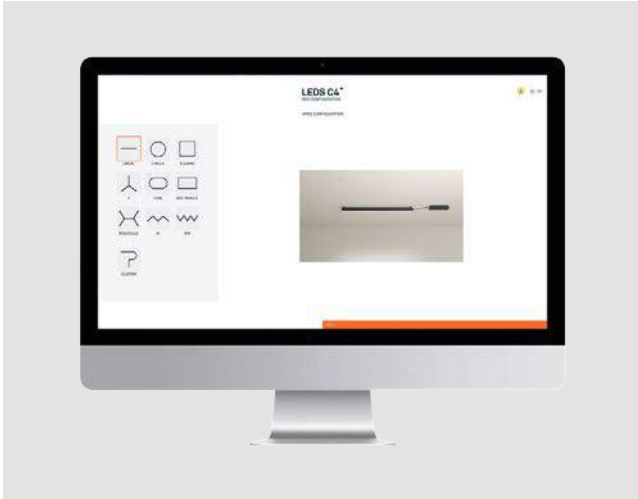

1. Auswahl der Standardform
Selezione della forma standard

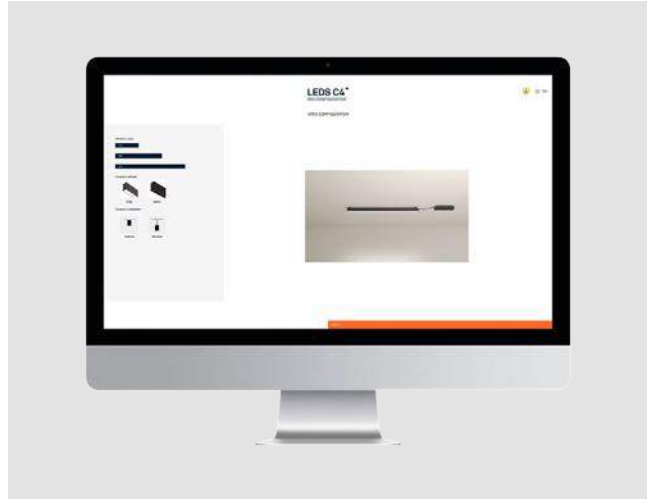

2. Auswahl von Größe, Diffusor und der Installation
Selezione di dimensione, diffusore e installazione

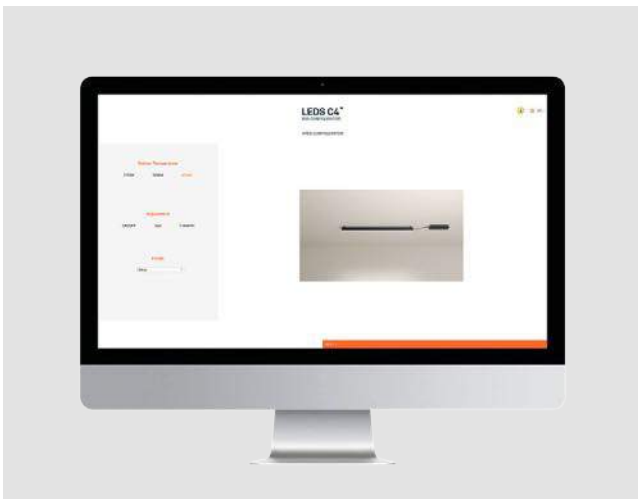

3. Auswahl von Farbtemperatur, Einstellung und Ausführung
Selezione della temperatura colore, regolazione e finitura

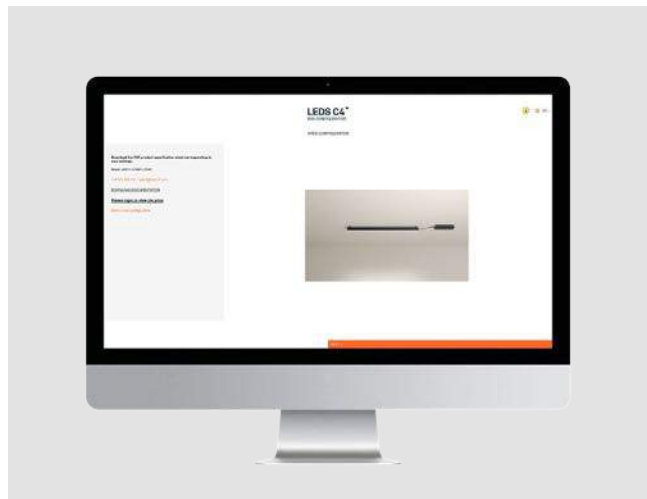

4. Download der Dokumentation
Scaricare documentazione

Custom



Benutzerdefinierte Auswahl
Selezione Custom

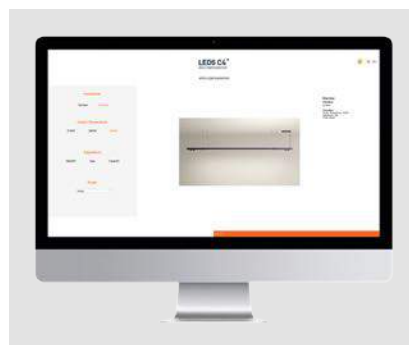

Auswahl von Installation, Farbtemperatur, Einstellung und Ausführung (benutzerdefiniert)
Selezione di installazione, temperatura colore, regolazione e finitura (custom)

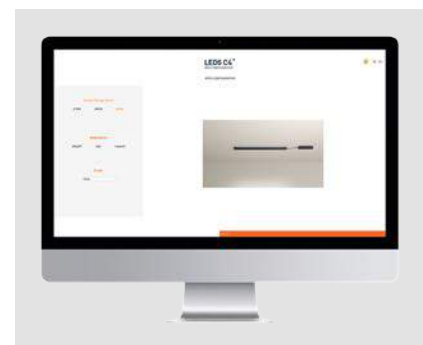

Erstellung einer benutzerdefinierten Form
Creazione forma Custom

APEX











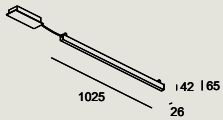





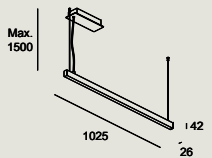

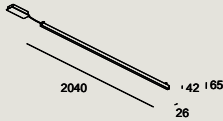

Lineal Simple

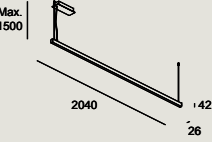

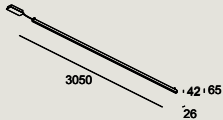
3
MacAdam

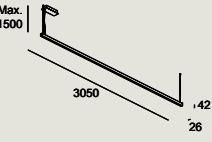

Codebeispiel / Esempio di codice: AW11-12VAPLOS14

Model	W	K/ CRI/ Real lm	Optics	Source	Finishes
 <p>AW11 - Lineal / Aufputz / 1025mm Lineal / Superficie / 1025mm</p>	12 12W	VA 2700K/CRI90/ 1042 lm	PL Opal	OS  ON-OFF/ 220-240V/50-60Hz	14  60 
		WA 3000K/CRI90/ 1042 lm		DS  DALI/220-240V/ 50-60Hz	
		XA 4000K/CRI90/ 1042 lm		XB  CASAMBI/ 220-240V/ 50-60Hz	
 <p>AW14 - Lineal / Hängend / 1025mm Lineal / Sospesa / 1025mm</p>	18 18W	V9 2700K/CRI90/ 1563 lm	BE Bento 52°		
		W9 3000K/CRI90/ 1563 lm			
		X9 4000K/CRI90/ 1563 lm			
 <p>AW12 - Lineal / Aufputz / 2040mm Lineal / Superficie / 2040mm</p>	24 24W	VA 2700K/CRI90/ 2084 lm	PL Opal	OS  ON-OFF/ 220-240V/50-60Hz	
		WA 3000K/CRI90/ 2084 lm		DS  DALI/220-240V/ 50-60Hz	
		XA 4000K/CRI90/ 2084 lm		XB  CASAMBI/ 220-240V/ 50-60Hz	
 <p>AW15 - Lineal / Hängend / 2040mm Lineal / Sospesa / 20040mm</p>	36 36W	V9 2700K/CRI90/ 3126 lm	BE Bento 52°		
		W9 3000K/CRI90/ 3126 lm			
		X9 4000K/CRI90/ 3126 lm			
 <p>AW13 - Lineal / Aufputz / 3050mm Lineal / Superficie / 3050mm</p>	36 36W	VA 2700K/CRI90/ 3126 lm	PL Opal	OS  ON-OFF/ 220-240V/50-60Hz	
		WA 3000K/CRI90/ 3126 lm		DS  DALI/220-240V/ 50-60Hz	
		XA 4000K/CRI90/ 3126 lm		XB  CASAMBI/ 220-240V/50-60Hz	
 <p>AW16 - Lineal / Hängend / 3050mm Lineal / Sospesa / 3050mm</p>	54 54W	V9 2700K/CRI90/ 4689 lm	BE Bento 52°		
		W9 3000K/CRI90/ 4689 lm			
		X9 4000K/CRI90/ 4689 lm			

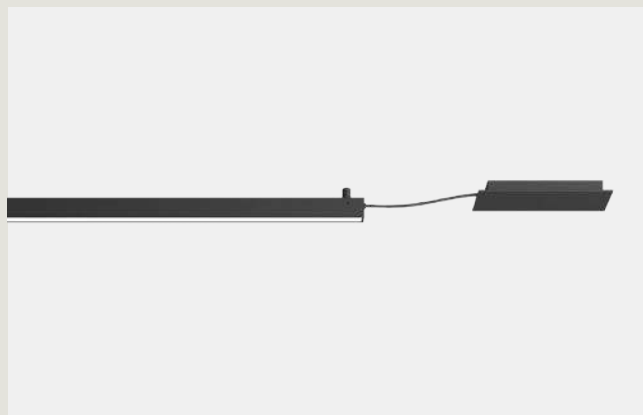

Installation oberfläche
Installazione in superficie

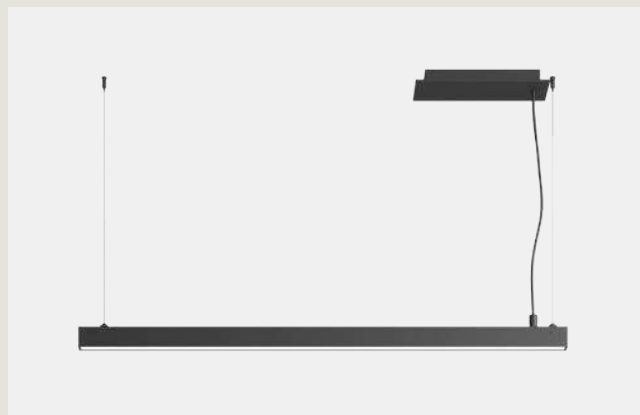



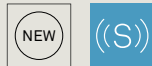





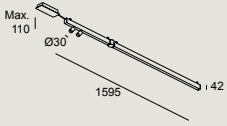



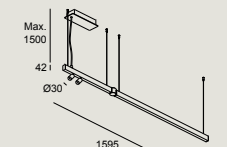
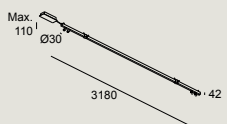

Installation hängend
installazione in sospensione

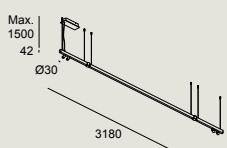
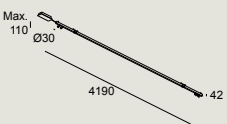

Lineal Double Spot Small

Codebeispiel / Esempio di codice: AW42-18VAPLOS14

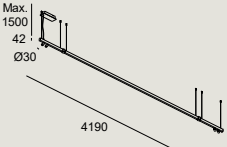









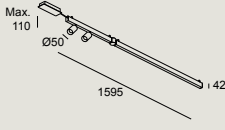

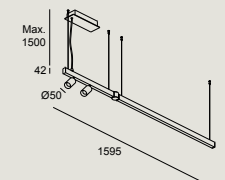

Model	W	K/ CRI/ Real lm	Optics	Source	Finishes
 <p>AW42 - Lineal / Aufputz / 1595mm / 2 Spots 30mm Lineal / Superficie / 1595mm / 2 Spots 30mm</p>	18 18W	VA 2700K/CRI90/ 1580 lm	PL Opal	OS  ON-OFF/ 220-240V/50-60Hz	14  60 
		WA 3000K/CRI90/ 1580 lm		DS  DALI/220-240V/ 50-60Hz	
		XA 4000K/CRI90/ 1580 lm		XB  CASAMBI/ 220-240V/ 50-60Hz	
 <p>AW45 - Lineal / Hängend / 1595mm / 2 Spots 30mm Lineal / Sospesa / 1595mm / 2 Spots 30mm</p>	24 24W	V9 2700K/CRI90/ 2101 lm	BE Bento 52°		
		W9 3000K/CRI90/ 2101 lm			
		X9 4000K/CRI90/ 2101 lm			
 <p>AW43 - Lineal / Aufputz / 3180mm / 4 Spots 30mm Lineal / Superficie / 3180mm / 4 Spots 30mm</p>	36 36W	VA 2700K/CRI90/ 2622 lm	PL Opal	OS  ON-OFF/ 220-240V/50-60Hz	
		WA 3000K/CRI90/ 2622 lm		DS  DALI/220-240V/ 50-60Hz	
		XA 4000K/CRI90/ 2622 lm		XB  CASAMBI/ 220-240V/ 50-60Hz	
 <p>AW46 - Lineal / Hängend / 3180mm / 4 Spots 30mm Lineal / Sospesa / 3180mm / 4 Spots 30mm</p>	48 48W	V9 2700K/CRI90/ 4202 lm	BE Bento 52°		
		W9 3000K/CRI90/ 4202 lm			
		X9 4000K/CRI90/ 4202 lm			
 <p>AW44 - Lineal / Aufputz / 4190mm / 4 Spots 30mm Lineal / Superficie / 4190mm / 4 Spots 30mm</p>	48 48W	VA 2700K/CRI90/ 4202 lm	PL Opal	OS  ON-OFF/ 220-240V/50-60Hz	
		WA 3000K/CRI90/ 4202 lm		DS  DALI/220-240V/ 50-60Hz	
		XA 4000K/CRI90/ 4202 lm		XB  CASAMBI/ 220-240V/ 50-60Hz	
 <p>AW47 - Lineal / Hängend / 4190mm / 4 Spots 30mm Lineal / Sospesa / 4190mm / 4 Spots 30mm</p>	66 66W	V9 2700K/CRI90/ 5765 lm	BE Bento 52°		
		W9 3000K/CRI90/ 5765 lm			
		X9 4000K/CRI90/ 5765 lm			

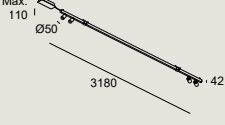

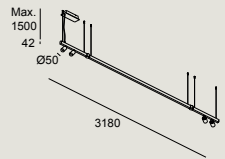
Spot 30mm

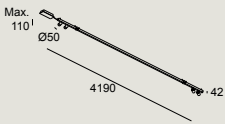
Lineal Double Spot Big

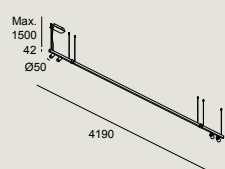
Codebeispiel / Esempio di codice: AW55-36VAPLOS14

Model	W	K/ CRI/ Real lm	Optics	Source	Finishes
 <p>AW55 - Lineal / Aufputz / 1595mm / 2 Spots 52mm Lineal / Superficie / 1595mm / 2 Spots 52mm</p>	36 36W	VA 2700K/CRI90/ 2898 lm	PL Opal	OS  ON-OFF/ 220-240V/50-60Hz	14  60 
		WA 3000K/CRI90/ 2898 lm			
		XA 4000K/CRI90/ 2898 lm			
 <p>AW58 - Lineal / Hängend / 1595mm / 2 Spots 52mm Lineal / Sospesa / 1595mm / 2 Spots 52mm</p>	42 42W	V9 2700K/CRI90/ 3419 lm	BE Bento 52°	DS  DALI/220-240V/ 50-60Hz	
		W9 3000K/CRI90/ 3419 lm			
		X9 4000K/CRI90/ 3419 lm			
 <p>AW56 - Lineal / Aufputz / 3180mm / 4 Spots 52mm Lineal / Superficie / 3180mm / 4 Spots 52mm</p>	72 72W	VA 2700K/CRI90/ 3940 lm	PL Opal	OS  ON-OFF/ 220-240V/50-60Hz	
		WA 3000K/CRI90/ 3940 lm			
		XA 4000K/CRI90/ 3940 lm			
 <p>AW59 - Lineal / Hängend / 3180mm / 4 Spots 52mm Lineal / Sospesa / 3180mm / 4 Spots 52mm</p>	84 84W	V9 2700K/CRI90/ 6838 lm	BE Bento 52°	DS  DALI/220-240V/ 50-60Hz	
		W9 3000K/CRI90/ 6838 lm			
		X9 4000K/CRI90/ 6838 lm			
 <p>AW57 - Lineal / Aufputz / 4190mm / 4 Spots 52mm Lineal / Superficie / 4190mm / 4 Spots 52mm</p>	84 84W	VA 2700K/CRI90/ 6838 lm	PL Opal	OS  ON-OFF/ 220-240V/50-60Hz	
		WA 3000K/CRI90/ 6838 lm			
		XA 4000K/CRI90/ 6838 lm			
 <p>AW61 - Lineal / Hängend / 4190mm / 4 Spots 52mm Lineal / Sospesa / 4190mm / 4 Spots 52mm</p>	CP 102W	V9 2700K/CRI90/ 8401 lm	BE Bento 52°	DS  DALI/220-240V/ 50-60Hz	
		W9 3000K/CRI90/ 8401 lm			
		X9 4000K/CRI90/ 8401 lm			



Spot 52mm



Lineal Triple Spot Small

Codebeispiel / Esempio di codice: AW48-21VAPLOS14

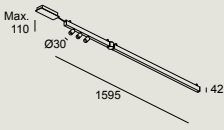
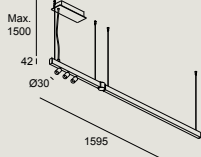
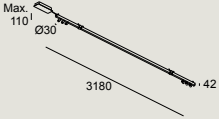
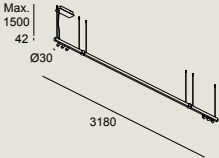
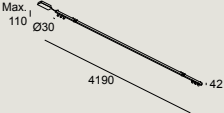
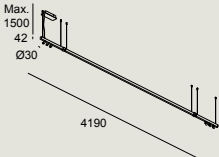
Model	W	K/ CRI/ Real lm	Optics	Source	Finishes
 <p>AW48 - Lineal / Aufputz / 1595mm / 3 Spots 30mm Lineal / Superficie / 1595mm / 3 Spots 30mm</p>	21 21W	VA 2700K/CRI90/ 1849 lm	PL Opal	OS ON-OFF/ 220-240V/50-60Hz DS DALI/220-240V/ 50-60Hz XB CASAMBI/ 220-240V/ 50-60Hz	14 60
		WA 3000K/CRI90/ 1849 lm			
		XA 4000K/CRI90/ 1849 lm			
 <p>AW52 - Lineal / Hängend / 1595mm / 3 Spots 30mm Lineal / Sospesa / 1595mm / 3 Spots 30mm</p>	27 27W	V9 2700K/CRI90/ 2370 lm	BE Bento 52°		
		W9 3000K/CRI90/ 2370 lm			
		X9 4000K/CRI90/ 2370 lm			
 <p>AW49 - Lineal / Aufputz / 3180mm / 6 Spots 30mm Lineal / Superficie / 3180mm / 6 Spots 30mm</p>	42 42W	VA 2700K/CRI90/ 3160 lm	PL Opal	OS ON-OFF/ 220-240V/50-60Hz DS DALI/220-240V/ 50-60Hz XB CASAMBI/ 220-240V/ 50-60Hz	
		WA 3000K/CRI90/ 3160 lm			
		XA 4000K/CRI90/ 3160 lm			
 <p>AW53 - Lineal / Hängend / 3180mm / 6 Spots 30mm Lineal / Sospesa / 3180mm / 6 Spots 30mm</p>	54 54W	V9 2700K/CRI90/ 4740 lm	BE Bento 52°		
		W9 3000K/CRI90/ 4740 lm			
		X9 4000K/CRI90/ 4740 lm			
 <p>AW51 - Lineal / Aufputz / 4190mm / 6 Spots 30mm Lineal / Superficie / 4190mm / 6 Spots 30mm</p>	54 54W	VA 2700K/CRI90/ 4740 lm	PL Opal	OS ON-OFF/ 220-240V/50-60Hz DS DALI/220-240V/ 50-60Hz XB CASAMBI/ 220-240V/ 50-60Hz	
		WA 3000K/CRI90/ 4740 lm			
		XA 4000K/CRI90/ 4740 lm			
 <p>AW54 - Lineal / Hängend / 4190mm / 6 Spots 30mm Lineal / Sospesa / 4190mm / 6 Spots 30mm</p>	72 72W	V9 2700K/CRI90/ 6303 lm	BE Bento 52°		
		W9 3000K/CRI90/ 6303 lm			
		X9 4000K/CRI90/ 6303 lm			

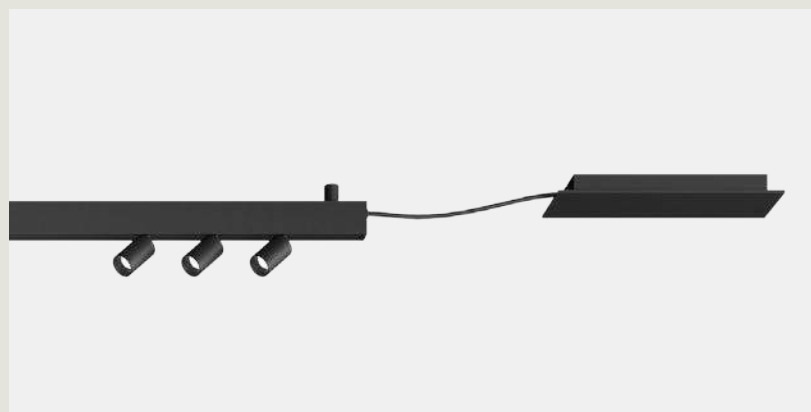

Installation oberfläche
Installazione in superficie

APEX Square



3
MacAdam

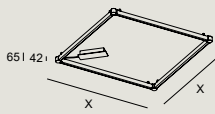
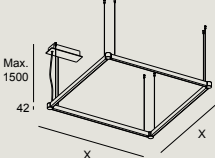
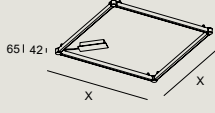
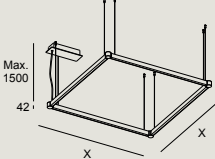
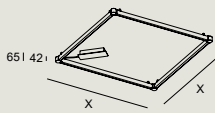
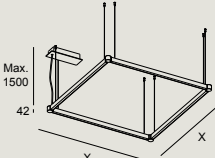

Codebeispiel / Esempio di codice: AW22-48VAPLOS14

Model	W	K/ CRI/ Real lm	Optics	Source	Finishes
 <p>AW22 - Square / Aufputz / 1000mm Square / Superficie / 1000mm</p>	48 48W	VA 2700K/CRI90/ 4168 lm	PL Opal	OS ON-OFF/ 220-240V/50-60Hz	14 60
		WA 3000K/CRI90/ 4168 lm		DS DALI/220-240V/ 50-60Hz	
		XA 4000K/CRI90/ 4168 lm		XB CASAMBI/ 220-240V/ 50-60Hz	
 <p>AW25 - Square / Hängend / 1000mm Square / Sospesa / 1000mm</p>	72 72W	V9 2700K/CRI90/ 6252 lm	BE Bento 52°		
		W9 3000K/CRI90/ 6252 lm			
		X9 4000K/CRI90/ 6252 lm			
 <p>AW23 - Square / Aufputz / 2000mm Square / Superficie / 2000mm</p>	96 96W	VA 2700K/CRI90/ 8336 lm	PL Opal	OS ON-OFF/ 220-240V/50-60Hz	
		WA 3000K/CRI90/ 8336 lm		DS DALI/220-240V/ 50-60Hz	
		XA 4000K/CRI90/ 8336 lm		XB CASAMBI/ 220-240V/ 50-60Hz	
 <p>AW26 - Square / Hängend / 2000mm Square / Sospesa / 2000mm</p>	C4 144W	V9 2700K/CRI90/ 12504 lm	BE Bento 52°		
		W9 3000K/CRI90/ 12504 lm			
		X9 4000K/CRI90/ 12504 lm			
 <p>AW24 - Square / Aufputz / 3000mm Square / Superficie / 3000mm</p>	C4 144W	VA 2700K/CRI90/ 12504 lm	PL Opal	OS ON-OFF/ 220-240V/50-60Hz	
		WA 3000K/CRI90/ 12504 lm		DS DALI/220-240V/ 50-60Hz	
		XA 4000K/CRI90/ 12504 lm		XB CASAMBI/ 220-240V/ 50-60Hz	
 <p>AW27 - Square / Hängend / 3000mm Square / Sospesa / 3000mm</p>	D1 216W	V9 2700K/CRI90/ 18756 lm	BE Bento 52°		
		W9 3000K/CRI90/ 12504 lm			
		X9 4000K/CRI90/ 12504 lm			



Installation oberfläche
Installazione in superficie

APEX

Rectangular



Codebeispiel / Esempio di codice: AW28-72VAPLOS14

Model	W	K/ CRI/ Real lm	Optics	Source	Finishes
<p>AW28 - Rectangular / Aufputz / 1125mm x 2140mm Rectangular / Superficie / 1125mm x 2140mm</p>	72 72W	VA 2700K/CRI90/ 6252 lm	PL Opal	OS ON-OFF/ 220-240V/50-60Hz DS DALI/220-240V/ 50-60Hz XB CASAMBI/ 220-240V/ 50-60Hz 	14 60
		WA 3000K/CRI90/ 6252 lm			
		XA 4000K/CRI90/ 6252 lm			
<p>AW29 - Rectangular / Hängend / 1125mm x 2140mm Rectangular / Sospesa / 1125mm x 2140mm</p>	CP 108W	V9 2700K/CRI90/ 9378 lm	BE Bento 52°		
		W9 3000K/CRI90/ 9378 lm			
		X9 4000K/CRI90/ 9378 lm			
<p>AW31 - Rectangular / Hängend / 1125mm x 3150mm Rectangular / Sospesa / 1125mm x 3150mm</p>	96 96W	VA 2700K/CRI90/ 8336 lm	PL Opal	OS ON-OFF/ 220-240V/50-60Hz DS DALI/220-240V/ 50-60Hz XB CASAMBI/ 220-240V/ 50-60Hz 	
		WA 3000K/CRI90/ 8336 lm			
		XA 4000K/CRI90/ 8336 lm			
<p>AW32 - Rectangular / Hängend / 1125mm x 3150mm Rectangular / Sospesa / 1125mm x 3150mm</p>	C4 144W	V9 2700K/CRI90/ 12504 lm	BE Bento 52°		
		W9 3000K/CRI90/ 9378 lm			
		X9 4000K/CRI90/ 9378 lm			













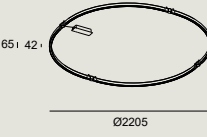

Bento optics

APEX

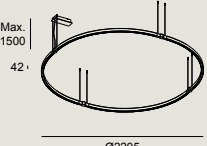
Circular & Oval

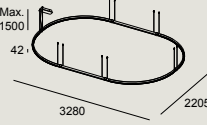

Codebeispiel / Esempio di codice: AW17-48VAPLOS14

Model	W	K/ CRI/ Real lm	Optics	Source	Finishes
 <p>AW17 - Circular / Aufputz Circular / Superficie</p> <p>65 42 Ø2205</p>	76 76W	VA 2700K/CRI90/ 6544 lm	PL Opal	OS  ON-OFF/ 220-240V/50-60Hz	14  60 
		WA 3000K/CRI90/ 6544 lm		DS  DALI/220-240V/ 50-60Hz	
		XA 4000K/CRI90/ 6544 lm		XB  CASAMBI/ 220-240V/ 50-60Hz 	
 <p>AW18 - Circular / Hängend Circular / Sospesa</p> <p>Max. 1500 42 Ø2205</p>					
 <p>AW19 - Oval / Aufputz Oval / Superficie</p> <p>65 42 3280 2205</p>	100 100W	VA 2700K/CRI90/ 8628 lm	PL Opal	OS  ON-OFF/ 220-240V/50-60Hz	
		WA 3000K/CRI90/ 8628 lm		DS  DALI/220-240V/ 50-60Hz	
		XA 4000K/CRI90/ 8628 lm		XB  CASAMBI/ 220-240V/ 50-60Hz 	
 <p>AW21 - Oval / Hängend Oval / Sospesa</p> <p>Max. 1500 42 3280 2205</p>					

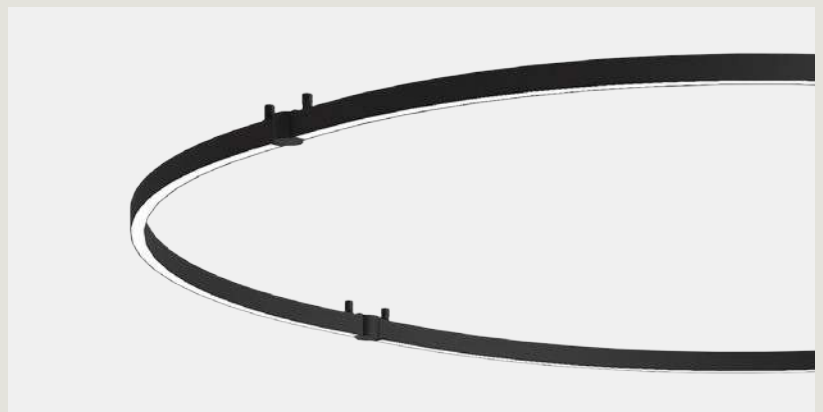







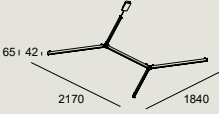

Aufputz
Superficie

APEX

Apex H

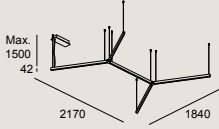

Codebeispiel / Esempio di codice: AW35-60VAPLOS14

Model	W	K/ CRI/ Real lm	Optics	Source	Finishes
 <p>AW35 - "H" / Aufputz "H" / Superficie</p>	60 60W	VA 2700K/CRI90/ 5210 lm	PL Opal	OS  ON-OFF/ 220-240V/50-60Hz	14  60 
		WA 3000K/CRI90/ 5210 lm		DS  DALI/220-240V/ 50-60Hz	
		XA 4000K/CRI90/ 5210 lm		XB  CASAMBI/ 220-240V/ 50-60Hz	
 <p>AW36 - "H" / Hängend "H" / Sospesa</p>	90 90W	V9 2700K/CRI90/ 7815 lm	BE Bento 52°		
		W9 3000K/CRI90/ 7815 lm			
		X9 4000K/CRI90/ 7815 lm			

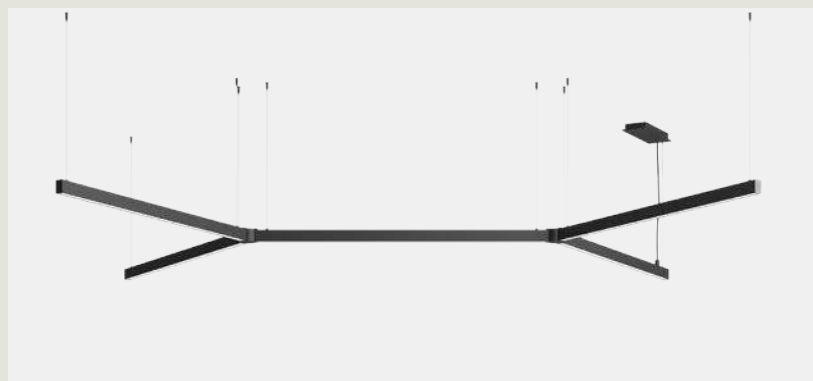







Installation hängend
installazione in sospensione

APEX

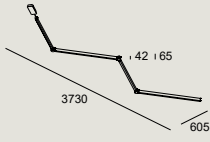
Apex M

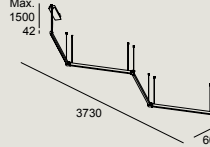

Codebeispiel / Esempio di codice: AW39-48VAPLOS14

Model	W	K/ CRI/ Real lm	Optics	Source	Finishes
 <p>AW39 - "M" / Aufputz "M" / Superficie</p>	48 48W	VA 2700K/CRI90/ 4168 lm	PL Opal	OS  ON-OFF/ 220-240V/50-60Hz	14  60 
		WA 3000K/CRI90/ 4168 lm		DS  DALI/220-240V/ 50-60Hz	
		XA 4000K/CRI90/ 4168 lm		XB  CASAMBI/ 220-240V/ 50-60Hz	
 <p>AW41 - "M" / Hängend "M" / Sospesa</p>	72 72W	V9 2700K/CRI90/ 6252 lm	BE Bento 52°		
		W9 3000K/CRI90/ 6252 lm			
		X9 4000K/CRI90/ 6252 lm			









Installation oberfläche
Installazione in superficie

APEX

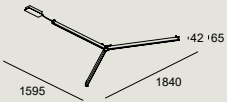
Apex Y

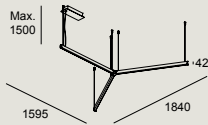

Codebeispiel / Esempio di codice: AW33-36VAPLOS14

Model	W	K/ CRI/ Real lm	Optics	Source	Finishes
 <p>AW33 - "Y" / Aufputz "Y" / Superficie</p>	36 36W	VA 2700K/CRI90/ 3126 lm	PL Opal	OS  ON-OFF/ 220-240V/ 50-60Hz	14  60 
		WA 3000K/CRI90/ 3126 lm		DS  DALI/220-240V/ 50-60Hz	
		XA 4000K/CRI90/ 3126 lm		XB  CASAMBI/ 220-240V/ 50-60Hz	
					
 <p>AW34 - "Y" / Hängend "Y" / Sospesa</p>	54 54W	V9 2700K/CRI90/ 4689 lm	BE Bento 52°		
		W9 3000K/CRI90/ 4689 lm			
		X9 4000K/CRI90/ 4689 lm			



Installation hängend
installazione in sospensione

APEX









Apex WW

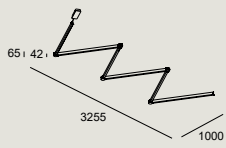

3
MacAdam

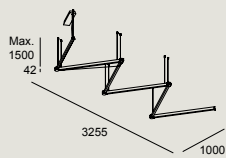

Codebeispiel / Esempio di codice: AW37-72VAPLOS14

Model	W	K/ CRI/ Real lm	Optics	Source	Finishes
 <p>AW37 - "WW" / Aufputz "WW" / Superficie</p>	72 72W	VA 2700K/CRI90/ 6252 lm	PL Opal	OS  ON-OFF/ 220-240V/ 50-60Hz	14  60 
		WA 3000K/CRI90/ 6252 lm		DS  DALI/220-240V/ 50-60Hz	
		XA 4000K/CRI90/ 6252 lm		XB  CASAMBI/ 220-240V/ 50-60Hz	
 <p>AW38 - "WW" / Hängend "WW" / Sospesa</p>	CP 108W	V9 2700K/CRI90/ 9378 lm	BE Bento 52°		
		W9 3000K/CRI90/ 9378 lm			
		X9 4000K/CRI90/ 9378 lm			

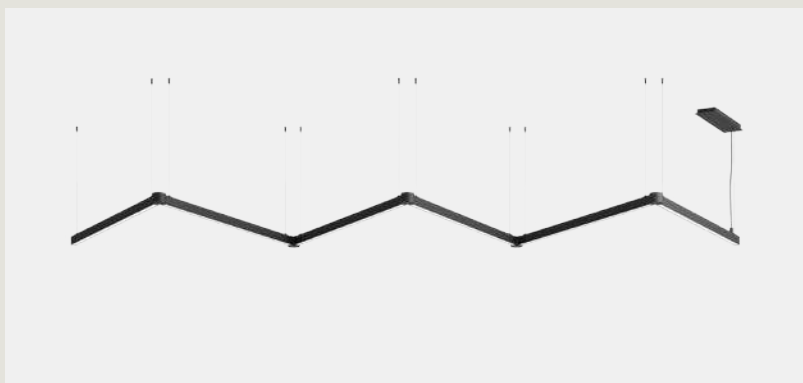

Installation hängend
installazione in sospensione



Strahler Proiettori

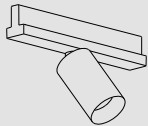

Atom

073

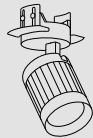

Iris

101

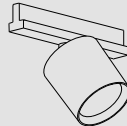

Tak

107

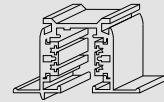

Track

111



Atom

Atom Track

P. 079



Ø 52



Ø 75



Ø 97

7,5-37,3 W



Ultra Spot - Ultra Flood
8° - 49°

14 ○ 60 ●



Atom Low voltage

P. 080



Ø 30



Ø 52

3,1-12,1 W



Ultra Spot - Ultra Flood
8° - 47°

14 ○ 60 ● 81 ● DN ●



Atom Hide

P. 081



Ø 30



Ø 52



Ø 75

3,1-24 W



Ultra Spot - Ultra Flood
8° - 47°

14 ○ 60 ● 81 ● DN ●



Atom Surface

P. 082



Ø 52



Ø 75

7,5 W



Extra Spot - Ultra Flood
16° - 47°

14 ○ 60 ● 81 ● DN ●

ATOM

BODY MAT	DIF MAT	50000h	3
AL	PC	L80 B20	MacAdam



Eine Kollektion von Strahlern mit minimalistischem Design und vielseitigen Einsatzmöglichkeiten sowie verschiedenen Installationslösungen (Dreiphasenschiene, Niederspannungsschiene, Auf- und Unterputz), die den Beleuchtungsanforderungen jedes Projekts gerecht werden. Dank des umfangreichen Zubehörs und der Möglichkeit, bis zu vier verschiedene Optiken aus derselben Familie zu wählen, ist diese Kollektion immer die richtige Wahl für die Beleuchtung von Geschäfts-, Restaurant- und Hotelräumen.

Collezione di faretti dotata di un design minimalista e con versatilità d'uso che offre diverse soluzioni d'installazione (binario trifase, binario a bassa tensione, in superficie e ad incasso) che rispondono alle esigenze illuminotecniche di ogni progetto. La sua vasta gamma di accessori e la possibilità di scegliere fino a quattro ottiche diverse, nella stessa famiglia, lo rendono un prodotto di successo, per illuminare spazi commerciali, ristoranti e spazi contract.

Optik-Optionen Opzioni di ottiche

Die Familie vereint bis zu vier verschiedene Winkel in derselben Kollektion, wodurch eine große Bandbreite an Öffnungswinkeln erreicht wird: von Ultra Spot bis Ultra Flood. Als Neuheit besitzt das Modell mit 75 mm Durchmesser eine 11°-Optik und das Modell mit 52 mm Durchmesser eine 8°-Optik, um die Akzentbeleuchtung zu verstärken.

Questa famiglia incorpora fino a 4 angoli diversi in una stessa collezione, ottenendo un'ampia gamma di apertura: da Ultra Spot a Ultra Flood. Come novità, un'ottica di 11° è incorporata nel modello di 75 mm di diametro e di 8° nel modello di 52 mm, per potenziare l'illuminazione d'accento.



Ultra Spot 8°

Atom Zoom

Diese als Neuheit in den Optionen Atom Track, Atom Low Voltage und Atom Hide enthaltene Variante ermöglicht mithilfe eines manuellen Zoomaktivierungssystems die Einstellung des optischen Winkels auf Ultra-Spot (16°). So wird eine dynamische und effektive Akzentbeleuchtung erzielt.

Questa opzione, inclusa come novità nelle opzioni Atom Track, Atom Low Voltage e Atom Hide, apre la possibilità di regolare l'angolo ottico ad un'apertura Ultra Spot (16°) tramite un sistema manuale di attivazione dello zoom. In questo modo otteniamo un'illuminazione d'accento, dinamica ed efficace.



Extra Spot 16°



Ultra Flood 47°

Effizienz und Kontrolle des Lichtstrahls

Efficienza e controllo del fascio

Sie verfügt über eine Polycarbonat-Linse, die eine optimale Kontrolle des Lichtstrahls ermöglicht und zusätzlich einen schmalen Effekt für eine größere Konzentration des Strahls bietet. Bei allen Modellen besteht die Möglichkeit, einen elliptischen Diffusor, ein Wabenpaneel und einen Strahldiffusor für eine bessere Kontrolle einzubauen.

Dispone di una lente in policarbonato che assicura un ottimo controllo del fascio di luce, oltre ad avere un effetto narrow per una maggiore concentrazione dello stesso fascio. Tutti i modelli offrono la possibilità di incorporare un diffusore ellittico, un pannello a nido d'ape e un diffusore del fascio per un maggior controllo.



Großes Angebot an Zubehör

Ampia gamma di accessori

Alle Teile können mit unterschiedlichem Zubehör wie z. B. dem Visuellen Komfort (Foto 4) und Blende (Foto 5), die sich perfekt zur Fokussierung des Lichtstrahls und zur Vermeidung von Blendwirkungen eignen, ausgestattet werden. Zusätzlich können sie mit verschiedenen Arten von Dekorringen (Foto 1, 2 und 3) ausgestattet werden, um sie aufzuwerten und an das jeweilige Projekt anzupassen. Das größere Atom Track-Modell ist zudem mit Blendschutzklappen kompatibel.

Tutti i pezzi accettano diversi accessori come il Comfort Visivo (foto 4) e la Visiera (foto 5), ideali per focalizzare il fascio di luce ed evitare l'abbagliamento o varie combinazioni di Anelli Frontali (foto 1, 2 e 3), per decorare il pezzo, adattandosi ad ogni progetto. Il modello più grande di Atom Track accetta anche le alette antiabbagliamento.



1



2



3



4



5

Smart



Tunable White



Vídeo ansehen
Guarda il video

Smart-Funktionen: Lichtatmosphären Funzionalità Smart: Atmosfera luminosa

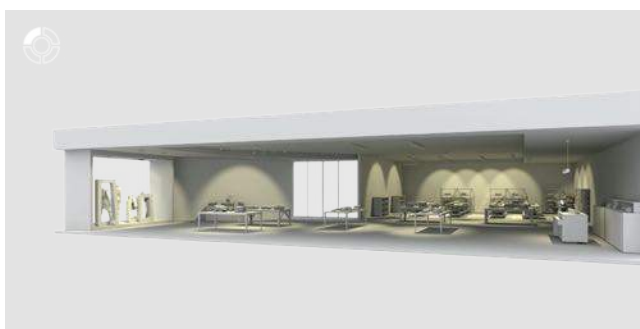

Atom ist erhältlich in Versionen mit eingebauter Casambi Bluetooth Mesh-Technologie, mit denen Sie die Flexibilität von Räumen in sich ständig ändernden Umgebungen verbessern können.

Atom dispone di versioni con tecnologia Casambi Bluetooth Mesh incorporata, permettendo di potenziare la flessibilità degli spazi in ambienti costantemente mutevoli.

Atom ist in Tunable White-Versionen erhältlich, bei denen die Farbtemperatur entweder manuell über ein Konnektivitätssystem oder durch automatische Anpassung der Farbtemperatur anhand eines Zeitprogramms eingestellt werden kann.

Atom dispone di versioni Tunable White che permettono una regolazione della temperatura di colore, sia manualmente, attraverso un sistema di connettività, o automaticamente, mediante una programmazione oraria.



Die Farbtemperatur und Helligkeit können angepasst werden, um die Arbeitsatmosphäre in einem geschäftlichen Umfeld zu verbessern, oder auch um ausgestellte Produkte in verschiedenen Farbtönen optimal zur Geltung zu bringen.

L'adattamento della temperatura di colore e la regolazione possono essere utilizzate per potenziare la sensazione che si vuol trasmettere ad un cliente in un ambiente commerciale, o in funzione delle diverse tonalità dei prodotti esposti.

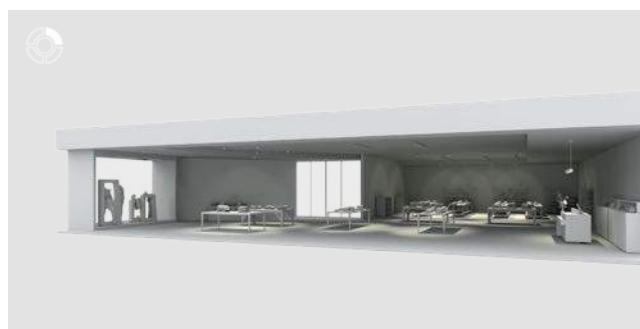



ATOM TRACK



Strahler für herkömmliche Dreiphasenschienen und DALI-Dreiphasenschienen mit Optionen für hohe Lichteffizienz. Zoom-Option in der Größe 52 mm.

Proiettore per binario trifase tradizionale e trifase DALI, con opzioni ad alta efficienza luminosa. Opzione Zoom nella misura di 52 mm.

Hohe Farbwiedergabe Alta resa cromatica

Das größte Modell verfügt über einen CRI-Wert von 98, der eine perfekte Farbwiedergabe garantiert und besonders für die Beleuchtung von Verkaufs- oder Ausstellungsräumen empfohlen wird.

Il modello più grande dispone di un CRI-98, che garantisce una perfetta riproduzione cromatica, particolarmente consigliata per l'illuminazione di spazi retail o espositivi.



ATOM LOW VOLTAGE



Das Charakteristische der Atom-Kollektion für die Niedervolt-schiene jetzt mit Atom Zoom in der Größe 52 mm.

L'essenza della collezione Atom su binario a bassa tensione con Atom Zoom nella misura di 52 mm.

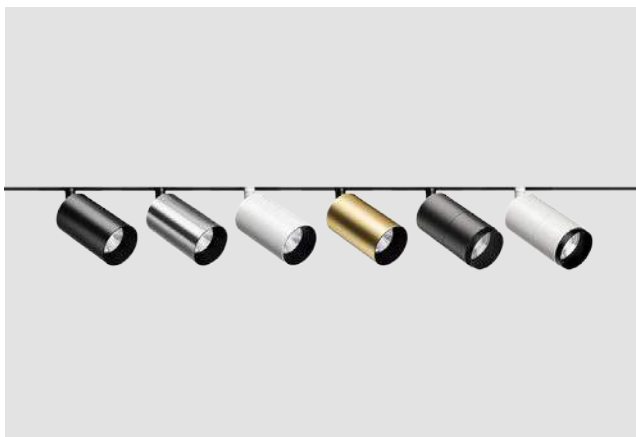

Magnetisches und einstellbares System Sistema magnetico e regolabile

Das Low-Voltage-System von C4 LEDS ermöglicht dank einer magnetischen Befestigung in allen Modulen eine einfache und schnelle Installation ohne Werkzeug. Zudem sorgt der miniaturisierte Strahler für eine Beleuchtung, die sich in den Raum einfügt.

Il sistema Low Voltage di LEDS C4 consente un fissaggio magnetico di tutti i moduli grazie ad un'installazione semplice, veloce e senza l'uso di strumenti. Inoltre, la miniaturizzazione del proiettore fornisce un'illuminazione integrata nello spazio.

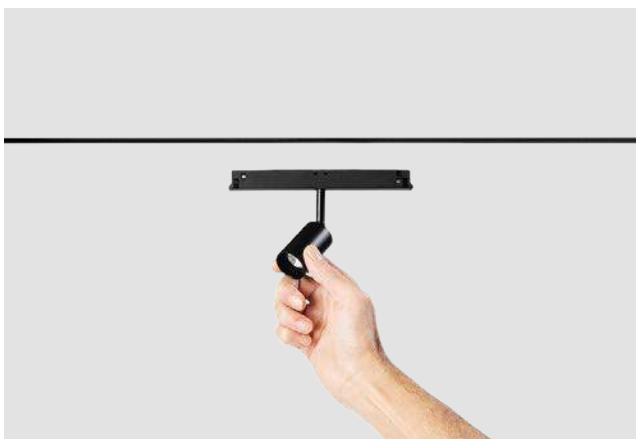

ATOM HIDE



In-Out-Strahler in drei verschiedenen Größen: Micro, Small und Medium.

Proiettore in-out che si presenta in tre diverse misure: micro, small e medium.

Vielseitig und anpassbar Versatile e adattabile

Bei der Zusammenstellung von Atom Hide lässt sich das Innenmodul austauschen, sodass es entsprechend den jeweiligen Beleuchtungsanforderungen jederzeit von einem Downlight zu einem Strahler umfunktioniert werden kann.

La composizione di Atom Hide permette di variare il modulo interno facendolo passare da downlight a proiettore secondo la necessità di illuminazione di ogni momento.

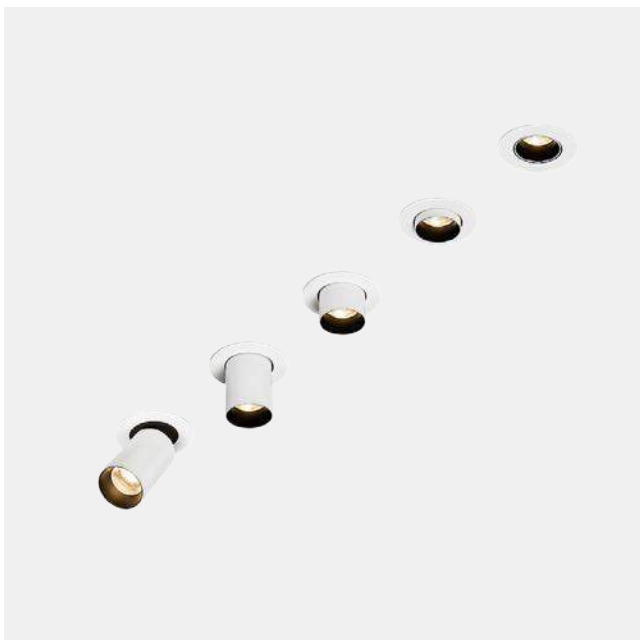

Atom Hide Zoom

Die Kollektion beinhaltet die Option Atom Hide Zoom in den Farben weiß und schwarz.

La collezione include la possibilità di Atom Hide Zoom nelle rifiniture in bianco e in nero.

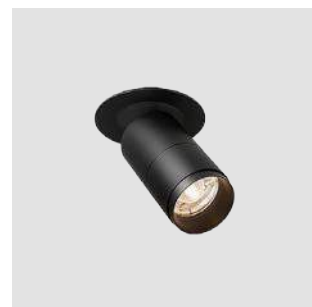

ATOM SURFACE



Aufputzoption mit einer Größe von 75 mm als Neuheit im breiten Angebot an Ausführungen in der Kollektion.

Versione da superficie che incorpora una misura di 75 mm in aggiunta alla vasta gamma di finiture disponibili in questa collezione.

180°-Drehfähigkeit Rotazione 180°

Eine der Grundfunktionen ist die Möglichkeit, den Strahler um 180° zu drehen, um ihn Einzelhandels- und Museumsprojekte anzupassen.

La possibilità di rotazione a 180° del proiettore è una funzionalità di base per adattarsi ad ogni tipo di progetti retail ed a musei.



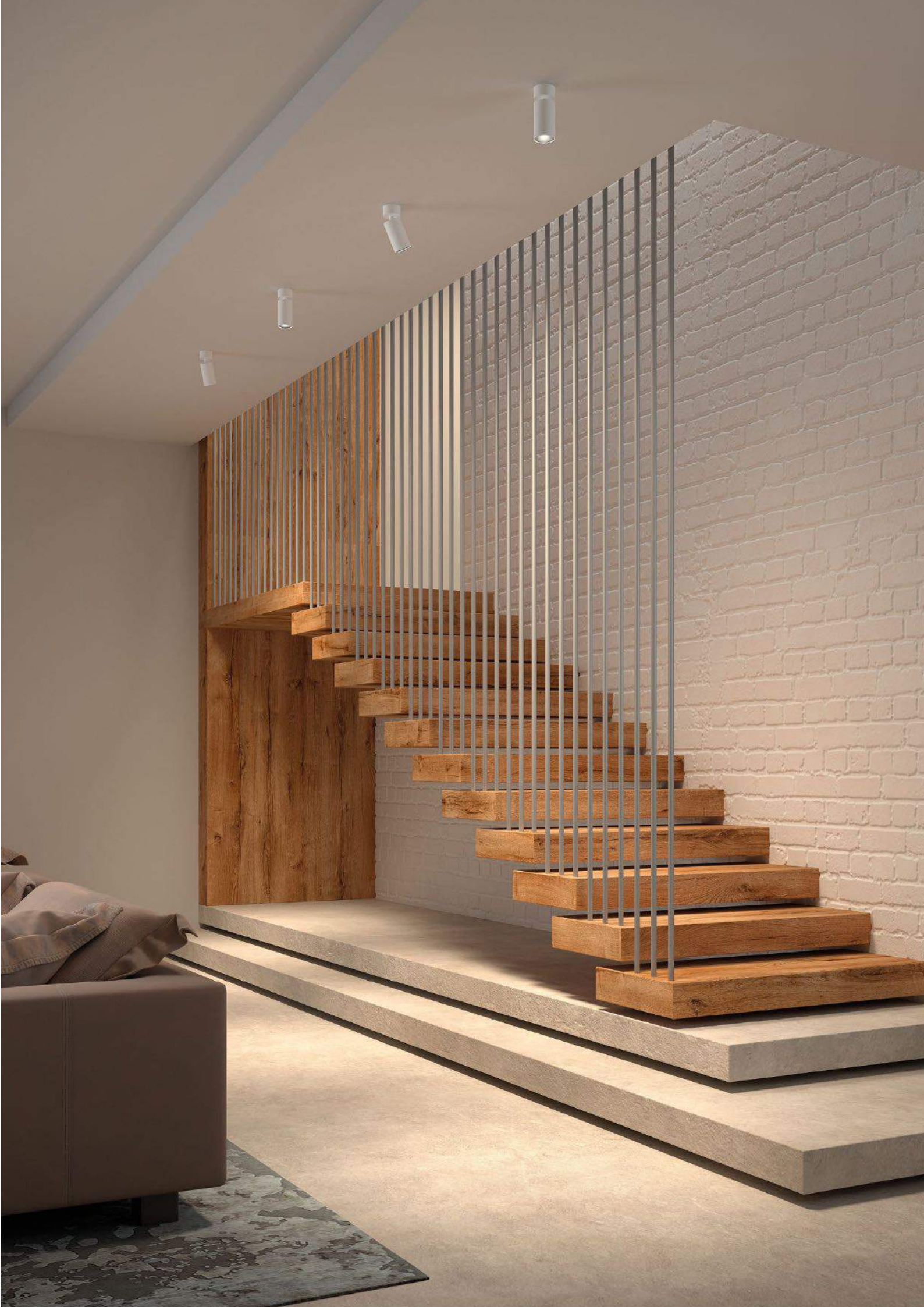

ATOM

Atom Track 52 LED AC

BODY MAT		IP	3				WELL	120V
AL		20	MacAdam	320°	90°	PHASE CUT		

14 60

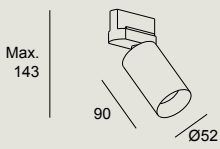

LED						
K	CRI	W LED	W Total	Real Lm	Optics	Code
3000	90	7.5	7.5	361	Medium 24°	35-6276
3000	90	7.5	7.5	304	Medium 32°	35-6277 - 14 - ML
3000	90	7.5	7.5	259	Flood 42°	35-6278
120V 50-60Hz						

nicht inklusive / Non incluso	
Montierungssatz Unterputz ohne Schiene Weiß Kit per installazione ad incasso bianco senza binario	71-5953-14-00
Montierungssatz Unterputz ohne Schiene Schwarz Kit per installazione ad incasso nero senza binario	71-5953-60-00
5 x Wabenraster 5 x Pannello a nido d'ape	71-6273-60-00
5 x Elliptischer Diffusor 5 x Diffusore ellittico	71-6274-00-00
5 x Weichzeichnerlinse 5 x Sagomatore di fascio	71-6275-00-00
Visueller Komfort Weiß Comfort visivo bianco	71-6276-14-00
Visueller Komfort Schwarz Comfort visivo nero	71-6276-60-00
Blende Visiera	71-6277-60-00
Vorderring Weiß Anello frontale bianco	71-6436-14-00
Vorderring Gold Anello frontale dorato	71-6436-23-00
Aufputz Montierungssatz Aufputz ohne Schiene Weiß Kit per installazione da superficie bianco senza binario	ACT-9105-14-00
Montierungssatz Aufputz ohne Schiene Schwarz Kit per installazione da superficie nero senza binario	ACT-9105-60-00

ATOM

Atom Track 52 LED DRIVER

BODY MAT
AL



IP
20

2
MacAdam



14 60

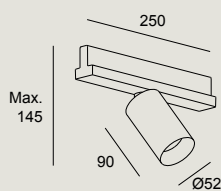

LED							
K	CRI	W LED	W Total	Real Lm	Optics	Code	
2700	90	12.7	15	428	Narrow 8°	35-A021 - 14	OS ES
2700	90	12.7	15	518	Zoom 16-47°	35-A060	OS
2700	90	12.7	15	853	Medium 24°	35-7287 - 14	ES
2700	90	12.7	15	928	Medium 32°	35-7288 - 60	XB
2700	90	12.7	15	778	Flood 44°	35-7289	
3000	90	12.7	15	437	Narrow 8°	35-A022 - 14	OS ES
3000	90	12.7	15	551	Zoom 16-47°	35-A061	OS
3000	90	12.7	15	853	Medium 24°	35-7290 - 14	ES
3000	90	12.7	15	928	Medium 32°	35-7291 - 60	XB
3000	90	12.7	15	778	Flood 44°	35-7292	
4000	90	12.7	15	459	Narrow 8°	35-A023 - 14	OS ES
4000	90	12.7	15	577	Zoom 16-47°	35-A062	OS
4000	90	12.7	15	981	Medium 24°	35-A003 - 14	ES
4000	90	12.7	15	1067	Medium 32°	35-A004 - 60	XB
4000	90	12.7	15	895	Flood 44°	35-A005	
2700-6500	90	12.3	14	926	Medium 23°	35-A066	OS
2700-6500	90	12.3	14	1089	Medium 38°	35-A067 - 14	TW
2700-6500	90	12.3	14	1076	Flood 49°	35-A068	
	OS	ON-OFF	220-240V	50-60Hz			
	ES	DALI-2	220-240V	50-60Hz			
	XB	Casambi	220-240V	50-60Hz			
	TW	DALI DT8	220-240V	50-60Hz			

nicht inklusive / Non incluso

5 x Wabenraster 5 x Pannello a nido d'ape	71-6273-60-00
5 x Elliptischer Diffusor 5 x Diffusore ellittico	71-6274-00-00
5 x Weichzeichnerlinse 5 x Sagomatore di fascio	71-6275-00-00
Visueller Komfort Weiß Comfort visivo bianco	71-6276-14-00
Visueller Komfort Schwarz Comfort visivo nero	71-6276-60-00
Blende Visiera	71-6277-60-00
Vorderring Weiß Anello frontale bianco	71-6436-14-00
Vorderring Gold Anello frontale dorato	71-6436-23-00

Smart Compatible-Zub. / Access. Smart Compatibile

35-A075-14-00	Multisensor D4i Track White
35-A075-60-00	Multisensor D4i Track Black
71-A243-14-14	Converter Casambi DALI Track White
71-A243-60-60	Converter Casambi DALI Track Black

ATOM

Atom Track 75 LED AC

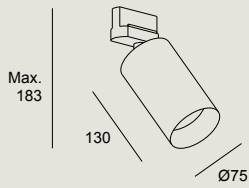

BODY MAT	DIF MAT		IP	3				WELL	120V
AL	PC		20	MacAdam	320°	90°	PHASE CUT		

14 60

LED						
K	CRI	W LED	W Total	Real Lm	Optics	Code
3000	90	14.3	14.3	1005	Medium 22°	35-6282
3000	90	14.3	14.3	861	Medium 31°	35-6283 - 14 - ML
3000	90	14.3	14.3	668	Medium 38°	35-6284
120V		50-60Hz				

nicht inklusive / Non incluso

Montierungssatz Unterputz ohne Schiene Weiß Kit per installazione ad incasso bianco senza binario	71-5953-14-00
Montierungssatz Unterputz ohne Schiene Schwarz Kit per installazione ad incasso nero senza binario	71-5953-60-00
5 x Wabenraster 5 x Pannello a nido d'ape	71-6279-60-00
5 x Elliptischer Diffusor 5 x Diffusore ellittico	71-6280-00-00
5 x Weichzeichnerlinse 5 x Sagomatore di fascio	71-6281-00-00
Visueller Komfort Weiß Comfort visivo bianco	71-6282-14-00
Visueller Komfort Schwarz Comfort visivo nero	71-6282-60-00
Blende Visiera	71-6283-60-00
Vorderring Weiß Anello frontale bianco	71-6437-14-00
Vorderring Gold Anello frontale dorato	71-6437-23-00
Aufputz Montierungssatz Aufputz ohne Schiene Weiß Kit per installazione da superficie bianco senza binario	ACT-9105-14-00
Montierungssatz Aufputz ohne Schiene Schwarz Kit per installazione da superficie nero senza binario	ACT-9105-60-00

ATOM

Atom Track 75 LED DRIVER

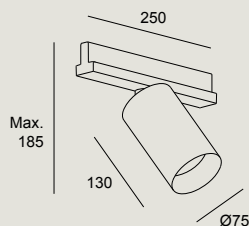

IP
20

2
MacAdam



14 60

LED									
K	CRI	W LED	W Total	Real Lm	Optics	Code			
2700	90	24	28	1634	Spot 16°	35-A018	14	OS	ES
2700	90	24	28	2404	Medium 22°	35-7305	14	OS	
2700	90	24	28	1991	Medium 35°	35-7306	60	ES	
2700	90	24	28	1567	Medium 40°	35-7307	60	XB	
3000	90	24	28	1667	Spot 16°	35-A019	14	OS	ES
3000	90	24	28	2404	Medium 22°	35-7308	14	OS	
3000	90	24	28	1991	Medium 35°	35-7309	60	ES	
3000	90	24	28	1567	Medium 40°	35-7310	60	XB	
4000	90	24	28	1751	Spot 16°	35-A020	14	OS	ES
4000	90	24	28	2765	Medium 22°	35-A009	14	OS	
4000	90	24	28	2290	Medium 35°	35-A010	60	ES	
4000	90	24	28	1802	Medium 40°	35-A011	60	XB	
TW 2700-6500	92	25.1	27.3	2214	Medium 21°	35-A051	14		
TW 2700-6500	92	25.1	27.3	2090	Medium 34°	35-A052	60		TW
TW 2700-6500	92	25.1	27.3	2078	Flood 46°	35-A053	60		

	OS	ON-OFF	220-240V	50-60Hz
	ES	DALI-2	220-240V	50-60Hz
	XB	Casambi	220-240V	50-60Hz
	TW	DALI DT8	220-240V	50-60Hz

nicht inklusive / Non incluso

5 x Wabenraster 5 x Pannello a nido d'ape	71-6279-60-00
5 x Elliptischer Diffusor 5 x Diffusore ellittico	71-6280-00-00
5 x Weichzeichnerlinse 5 x Sagomatore di fascio	71-6281-00-00
Visueller Komfort Weiß Comfort visivo bianco	71-6282-14-00
Visueller Komfort Schwarz Comfort visivo nero	71-6282-60-00
Blende Visiera	71-6283-60-00
Vorderring Weiß Anello frontale bianco	71-6437-14-00
Vorderring Gold Anello frontale dorato	71-6437-23-00

Smart Compatible-Zub. / Access. Smart Compatibile

35-A075-14-00	Multisensor D4i Track White
35-A075-60-00	Multisensor D4i Track Black
71-A243-14-14	Converter Casambi DALI Track White
71-A243-60-60	Converter Casambi DALI Track Black

ATOM

Atom Track 97 LED AC

BODY MAT	DIF MAT		IP	3		320°		90°	PHASE CUT	WELL	120V
AL	PC		20	MacAdam							

14 60

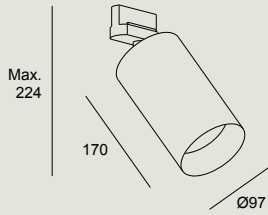

LED						
K	CRI	W LED	W Total	Real Lm	Optics	Code
3000	90	31	31	1850	Medium 24°	35-6288
3000	90	31	31	1586	Medium 36°	35-6289 - 14 - ML
3000	90	31	31	1252	Flood 43°	35-6290
120V		50-60Hz				

nicht inklusive / Non incluso

Montierungssatz Unterputz ohne Schiene Weiß Kit per installazione ad incasso bianco senza binario	71-5953-14-00
Montierungssatz Unterputz ohne Schiene Schwarz Kit per installazione ad incasso nero senza binario	71-5953-60-00
5 x Wabenraster 5 x Pannello a nido d'ape	71-6285-60-00
5 x Elliptischer Diffusor 5 x Diffusore ellittico	71-6286-00-00
5 x Weichzeichnerlinse 5 x Sagomatore di fascio	71-6287-00-00
Visueller Komfort Weiß Comfort visivo bianco	71-6288-14-00
Visueller Komfort Schwarz Comfort visivo nero	71-6288-60-00
Blende Visiera	71-6289-60-00
Blendschutzflügel Weiß Alette antiriflesso bianco	71-6290-14-00
Blendschutzflügel Schwarz Alette antiriflesso nero	71-6290-60-00
Vorderring Weiß Anello frontale bianco	71-6438-14-00
Vorderring Gold Anello frontale dorato	71-6438-23-00
Aufputz Montierungssatz Aufputz ohne Schiene Weiß Kit per installazione da superficie bianco senza binario	ACT-9105-14-00
Montierungssatz Aufputz ohne Schiene Schwarz Kit per installazione da superficie nero senza binario	ACT-9105-60-00

ATOM

Atom Track 97 LED DRIVER

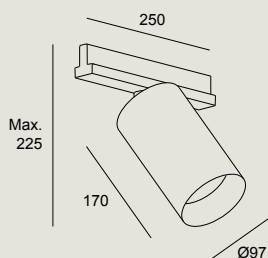

IP	2	(S)	(SC)	WELL	LOW
20	MacAdam				FLICKER

14 60

LED									
K	CRI	W LED	W Total	Real Lm	Optics	Code			
2700	90	37.3	42	3529	Spot 20°	35-7323	14	OS	
2700	90	37.3	42	3056	Medium 31°	35-7324	60	ES	
2700	90	37.3	42	2369	Flood 42°	35-7325		XB	
3000	90	37.3	42	3529	Spot 20°	35-7326	14	OS	
3000	90	37.3	42	3056	Medium 31°	35-7327	60	ES	
3000	90	37.3	42	2369	Flood 42°	35-7328		XB	
3000	98	37.3	42	2468	Spot 20°	35-7323	14	EF	
3000	98	37.3	42	2137	Medium 31°	35-7324	60	OF	
3000	98	37.3	42	1656	Flood 42°	35-7325			
4000	90	37.3	42	4059	Spot 20°	35-A015	14	OS	
4000	90	37.3	42	3514	Medium 31°	35-A016	60	ES	
4000	90	37.3	42	2724	Flood 43°	35-A017		XB	
TW 2700-6500	92	33	37	3118	Medium 22°	35-A077	14		
TW 2700-6500	92	33	37	2892	Medium 32°	35-A078	60	TW	
TW 2700-6500	92	33	37	2212	Medium 40°	35-A079			

OS	ON-OFF	220-240V	50-60Hz
ES	DALI-2	220-240V	50-60Hz
XB	Casambi	220-240V	50-60Hz
TW	DALI DT8	220-240V	50-60Hz
EF	DALI-2	220-240V	50-60Hz
OF	ON-OFF	220-240V	50-60Hz

nicht inklusive / Non incluso

5 x Wabenraster 5 x Pannello a nido d'ape	71-6285-60-00
5 x Elliptischer Diffusor 5 x Diffusore ellittico	71-6286-00-00
5 x Weichzeichnerlinse 5 x Sagomatore di fascio	71-6287-00-00
Visueller Komfort Weiß Comfort visivo bianco	71-6288-14-00
Visueller Komfort Schwarz Comfort visivo nero	71-6288-60-00
Blende Visiera	71-6289-60-00
Blendschutzflügel Weiß Alette antiriflesso bianco	71-6290-14-00
Blendschutzflügel Schwarz Alette antiriflesso nero	71-6290-60-00
Vorderring Weiß Anello frontale bianco	71-6438-14-00
Vorderring Gold Anello frontale dorato	71-6438-23-00

Smart Compatible-Zub. / Access. Smart Compatibile

35-A075-14-00	Multisensor D4i Track White
35-A075-60-00	Multisensor D4i Track Black
71-A243-14-14	Converter Casambi DALI Track White
71-A243-60-60	Converter Casambi DALI Track Black

ATOM

Atom Low Voltage

BODY MAT
AL



IP
20

2
MacAdam

WELL



14 60 81 DN

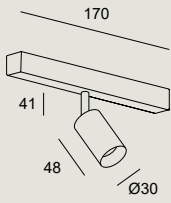

LED										
K	CRI	W LED	W Total	Real Lm	Optics	Code				
2700	90	3.1	4.6	269	Medium 37°	35-7285	14	00		
							60	DA		
							81	XB		
	DN									
3000	90	3.1	4.6	269	Medium 37°	35-7286	14	00		
							60	DA		
							81	XB		
	DN									
00	ON-OFF									
DA	DALI									
XB	Casambi									
	48 VDC									

Smart Compatible-Zub. / Access. Smart Compatibile
71-8115-00-00 Converter Casambi DALI Low Voltage

ATOM

Atom Low Voltage

BODY MAT
AL



IP
20

WELL



14 60 81 DN

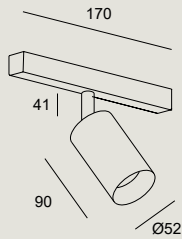

LED									
K	CRI	W LED	W Total	Real Lm	Optics	Code			
2700	90	8.5	10.2	428	Narrow 8°	35-A072	14	00	
2700	90	12.7	15	853	Medium 24°	35-7279	60	DA	
2700	90	12.7	15	928	Medium 32°	35-7280	81	XB	
2700	90	12.7	15	778	Flood 44°	35-7281	DN		
							14	00	
2700	90	12.7	15	518	Zoom 16-47°	35-A063	60	DA	
							14	00	
3000	90	8.5	10.2	437	Narrow 8°	35-A073	14	00	
3000	90	12.7	15	853	Medium 24°	35-7282	60	DA	
3000	90	12.7	15	928	Medium 32°	35-7283	81	XB	
3000	90	12.7	15	778	Flood 44°	35-7284	DN		
							14	00	
3000	90	12.7	15	551	Zoom 16-47°	35-A064	60	DA	
							14	00	
							60	DA	
							81	XB	
							DN		
ON-OFF DALI Casambi									
48 VDC									

nicht inklusive / Non incluso	
5 x Wabenraster 5 x Pannello a nido d'ape	71-6273-60-00
5 x Elliptischer Diffusor 5 x Diffusore ellittico	71-6274-00-00
5 x Weichzeichnerlinse 5 x Sagomatore di fascio	71-6275-00-00
Visueller Komfort Weiß Comfort visivo bianco	71-6276-14-00
Visueller Komfort Schwarz Comfort visivo nero	71-6276-60-00
Blende Visiera	71-6277-60-00
Vorderring Weiß Anello frontale bianco	71-6436-14-00
Vorderring Gold Anello frontale dorato	71-6436-23-00

Smart Compatible-Zub. / Access. Smart Compatibile
71-8115-00-00 Converter Casambi DALI Low Voltage

ATOM

Atom Hide

BODY MAT		IP	2				WELL	
AL		20	MacAdam	320°	90°			

14 60

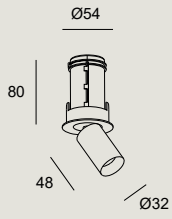

LED Max. 350mA 9V						
K	CRI	W LED	W Total	Real Lm	Optics	Code
2700	90	3.1	3.1	269	Medium 37°	90-8013 - ¹⁴ / ₆₀ - 00
3000	90	3.1	3.1	269	Medium 37°	90-8014 - ¹⁴ / ₆₀ - 00
ON-OFF	ON-OFF	1-10V/PUSH	DALI/DALI2	PHASE CUT 240V/PUSH	CASAMBI	
71-3542	71-7364	71-7710	71-6192	71-4898	71-A260	

ATOM

Atom Hide



14 60 81 DN

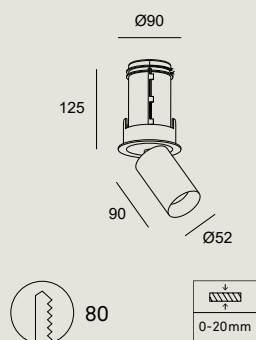

LED Max. 350mA 36V									
K	CRI	W LED	W Total	Real Lm	Optics	Code			
2700	90	12.7	12.7	518	Zoom 16°-47°	90-A060 - 14 - 60 - 00			
2700	90	12.7	12.7	853	Medium 24°	90-7273 - 14 - 60 - 00			
2700	90	12.7	12.7	928	Medium 32°	90-7274 - 81 - 00			
2700	90	12.7	12.7	778	Flood 44°	90-7275 - DN			
3000	90	12.7	12.7	551	Zoom 16°-47°	90-A061 - 14 - 60 - 00			
3000	90	12.7	12.7	853	Medium 24°	90-7276 - 14 - 60 - 00			
3000	90	12.7	12.7	928	Medium 32°	90-7277 - 81 - 00			
3000	90	12.7	12.7	778	Flood 44°	90-7278 - DN			
4000	90	12.7	12.7	577	Zoom 16°-47°	90-A062 - 14 - 60 - 00			
4000	90	12.7	12.7	981	Medium 24°	90-A003 - 14 - 60 - 00			
4000	90	12.7	12.7	1067	Medium 32°	90-A004 - 81 - 00			
4000	90	12.7	12.7	895	Flood 44°	90-A005 - DN			
71-6652		71-A260		71-A191		71-7710		71-A297	

nicht inklusive / Non incluso	
5 x Wabenraster 5 x Pannello a nido d'ape	71-6273-60-00
5 x Elliptischer Diffusor 5 x Diffusore ellittico	71-6274-00-00
5 x Weichzeichnerlinse 5 x Sagomatore di fascio	71-6275-00-00
Visueller Komfort Weiß Comfort visivo bianco	71-6276-14-00
Visueller Komfort Schwarz Comfort visivo nero	71-6276-60-00
Blende Visiera	71-6277-60-00
Vorderring Weiß Anello frontale bianco	71-6436-14-00
Vorderring Gold Anello frontale dorato	71-6436-23-00

ATOM

Atom Hide

BODY MAT		IP	3				WELL	
AL		20	MacAdam	320°	90°			

14 60 81 DN

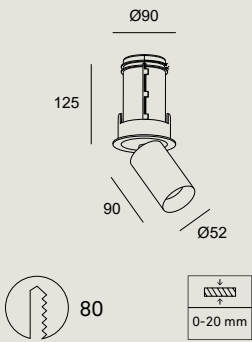

LED Max. 700mA 12V									
K	CRI	W LED	W Total	Real Lm	Optics	Code			
2700	90	12.7	12.7	428	Narrow 8°	90-A021 - 14 60 81 DN - 00			
3000	90	12.7	12.7	437	Narrow 8°	90-A038 - 14 60 81 DN - 00			
4000	90	12.7	12.7	459	Narrow 8°	90-A039 - 14 60 81 DN - 00			
	ON-OFF		DALI2/PUSH		1-10V/PUSH		PHASE CUT 240V		CASAMBI
71-6651		71-A190		71-7710		71-7663		71-A261	

nicht inklusive / Non incluso	
5 x Wabenraster 5 x Pannello a nido d'ape	71-6273-60-00
5 x Elliptischer Diffusor 5 x Diffusore ellittico	71-6274-00-00
5 x Weichzeichnerlinse 5 x Sagomatore di fascio	71-6275-00-00
Visueller Komfort Weiß Comfort visivo bianco	71-6276-14-00
Visueller Komfort Schwarz Comfort visivo nero	71-6276-60-00
Blende Visiera	71-6277-60-00
Vorderring Weiß Anello frontale bianco	71-6436-14-00
Vorderring Gold Anello frontale dorato	71-6436-23-00

ATOM

Atom Hide

BODY MAT		2				WELL	
AL		MacAdam					

14 60

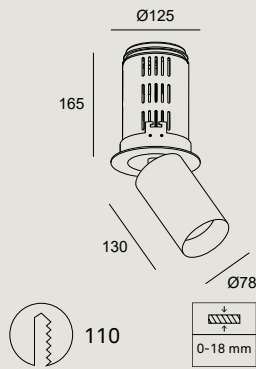

LED Max. 700mA 36V						
K	CRI	W LED	Real Lm	Optics	Code	
2700	90	24	2404	Medium 22°	90-8007	
2700	90	24	1991	Medium 35°	90-8008 - 14 - 00	
2700	90	24	1567	Medium 40°	90-8009 - 60 - 00	
3000	90	24	2404	Medium 22°	90-8010	
3000	90	24	1991	Medium 35°	90-8011 - 14 - 00	
3000	90	24	1567	Medium 40°	90-8012 - 60 - 00	
4000	90	24	2765	Medium 22°	90-A009	
4000	90	24	2290	Medium 35°	90-A010 - 14 - 00	
4000	90	24	1802	Medium 40°	90-A011 - 60 - 00	

ON-OFF	1-10V/PUSH	CASAMBI	DALI2	PHASE CUT 240V
71-6653	71-4708	71-A260	71-A192	71-A299

nicht inklusive / Non incluso	
5 x Wabenraster 5 x Pannello a nido d'ape	71-6279-60-00
5 x Elliptischer Diffusor 5 x Diffusore ellittico	71-6280-00-00
5 x Weichzeichnerlinse 5 x Sagomatore di fascio	71-6281-00-00
Visueller Komfort Weiß Comfort visivo bianco	71-6282-14-00
Visueller Komfort Schwarz Comfort visivo nero	71-6282-60-00
Blende Visiera	71-6283-60-00
Vorderring Weiß Anello frontale bianco	71-6437-14-00
Vorderring Gold Anello frontale dorato	71-6437-23-00

ATOM

Atom Hide

BODY MAT		IP	2				WELL	
AL		20	MacAdam	320°	90°			

14 60

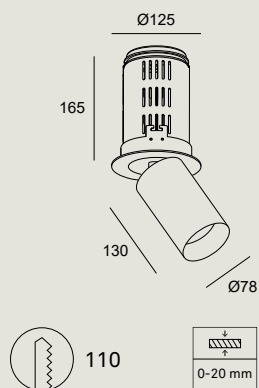

LED Max. 350mA 36V						
K	CRI	W LED	W Total	Real Lm	Optics	Code
2700	90	24	24	1634	Spot 16°	90-A040 - 14 - 60 - 00
3000	90	24	24	1667	Spot 16°	90-A019 - 14 - 60 - 00
4000	90	24	24	1751	Spot 16°	90-A041 - 14 - 60 - 00

ON-OFF	CASAMBI	DALI2/PUSH	1-10V/PUSH	PHASE CUT 240V
71-6652	71-A260	71-A191	71-7710	71-A297

nicht inklusive / Non incluso	
5 x Wabenraster 5 x Pannello a nido d'ape	71-6279-60-00
5 x Elliptischer Diffusor 5 x Diffusore ellittico	71-6280-00-00
5 x Weichzeichnerlinse 5 x Sagomatore di fascio	71-6281-00-00
Visueller Komfort Weiß Comfort visivo bianco	71-6282-14-00
Visueller Komfort Schwarz Comfort visivo nero	71-6282-60-00
Blende Visiera	71-6283-60-00
Vorderring Weiß Anello frontale bianco	71-6437-14-00
Vorderring Gold Anello frontale dorato	71-6437-23-00

ATOM

Atom Surface

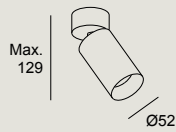

BODY MAT	DIF MAT	IP	3	320°	90°	PHASE CUT	WELL	120V
AL	PC	20	MacAdam					

14 60 81 DN

LED							
K	CRI	W LED	W Total	Real Lm	Optics	Code	
3000	90	7.5	7.5	331	Medium 24°	15-6485	14
3000	90	7.5	7.5	319	Medium 32°	15-6486	60 - ML
3000	90	7.5	7.5	259	Flood 43°	15-6487	81 DN





	120V	50-60Hz
--	------	---------



nicht inklusive / Non incluso	
5 x Wabenraster 5 x Pannello a nido d'ape	71-6273-60-00
5 x Elliptischer Diffusor 5 x Diffusore ellittico	71-6274-00-00
5 x Weichzeichnerlinse 5 x Sagomatore di fascio	71-6275-00-00
Visueller Komfort Schwarz Comfort visivo nero	71-6276-60-00
Blende Visiera	71-6277-60-00
Vorderring Weiß Anello frontale bianco	71-6436-14-00
Vorderring Gold Anello frontale dorato	71-6436-23-00





ATOM

Atom Surface

BODY MAT		IP	3				WELL	120V
AL		20	MacAdam	320°	90°	ON-OFF		

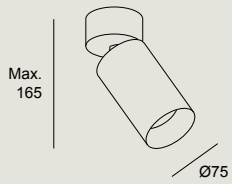
14  60 



LED						
K	CRI	W LED	W Total	Real Lm	Optics	Code
3000	90	14.3	14.3	1005	Medium 22°	15-6282
3000	90	14.3	14.3	861	Medium 31°	15-6283 - 14 - ML
3000	90	14.3	14.3	668	Medium 39°	15-6284
						
120V		50-60Hz				

nicht inklusive / Non incluso	
5 x Wabenraster 5 x Pannello a nido d'ape	71-6279-60-00
5 x Elliptischer Diffusor 5 x Diffusore ellittico	71-6280-00-00
5 x Weichzeichnerlinse 5 x Sagomatore di fascio	71-6281-00-00
Visueller Komfort Weiß Comfort visivo bianco	71-6282-14-00
Visueller Komfort Schwarz Comfort visivo nero	71-6282-60-00
Blende Visiera	71-6283-60-00
Vorderring Weiß Anello frontale bianco	71-6437-14-00
Vorderring Gold Anello frontale dorato	71-6437-23-00

ATOM

Atom Surface

BODY MAT		IP	2			WELL	
AL		20	MacAdam	320°	90°		

14 60



LED Max. 350mA 36V						
K	CRI	W LED	W Total	Real Lm	Optics	Code
2700	90	14.3	14.3	1634	Spot 16°	15-A018 - 14 - 60 - 00
3000	90	14.3	14.3	1667	Spot 16°	15-A019 - 14 - 60 - 00
4000	90	14.3	14.3	1751	Spot 16°	15-A020 - 14 - 60 - 00
71-6652	71-A260	71-A191	71-7710	71-A297		

ATOM

Atom Surface

BODY MAT		IP	2			WELL	
AL		20	MacAdam	320°	90°		

14 60

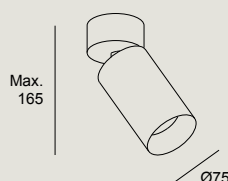

LED Max. 700mA 36V						
K	CRI	W LED	W Total	Real Lm	Optics	Code
2700	90	24	24	2404	Medium 22°	15-7305
2700	90	24	24	1991	Medium 35°	15-7306 - 14 - 60 - 00
2700	90	24	24	1567	Medium 40°	15-7307
3000	90	24	24	2404	Medium 22°	15-7308
3000	90	24	24	1991	Medium 35°	15-7309 - 14 - 60 - 00
3000	90	24	24	1567	Medium 40°	15-7310
4000	90	24	24	2765	Medium 22°	15-A024
4000	90	24	24	2290	Medium 35°	15-A025 - 14 - 60 - 00
4000	90	24	24	1802	Medium 40°	15-A026
71-6653	71-4708	71-A260	71-A192	71-A299		

Der Treiber muss ausserhalb der Leuchte installiert werden
Il driver deve essere installato in remoto

nicht mitgeliefertes
allgemeines Zub.
Access. comuni non inclusi

5 x Wabenraster 5 x Pannello a nido d'ape	71-6279-60-00
5 x Elliptischer Diffusor 5 x Diffusore ellittico	71-6280-00-00
5 x Weichzeichnerlinse 5 x Sagomatore di fascio	71-6281-00-00
Visueller Komfort Weiß Comfort visivo bianco	71-6282-14-00
Visueller Komfort Schwarz Comfort visivo nero	71-6282-60-00
Blende Visiera	71-6283-60-00
Vorderring Weiß Anello frontale bianco	71-6437-14-00
Vorderring Gold Anello frontale dorato	71-6437-23-00



Iris

SUMMALAB 2022

BODY MAT		50000h	2
AL		L80 B20	MacAdam



Ein Licht für jeden Augenblick
Una luce per ogni momento

Die modulare Produktfamilie Iris umfasst eine Strahlerversion mit verschiedenen Installationslösungen (Drehstromschiene, Niederspannungsschiene, Strahler mit externem Gerät und Aufbauinstallation). Alle Optionen der Produktfamilie Iris sind in 2 Modulen mit verschiedenen Leistungen (6W, 12 W, 18W) erhältlich, damit sie den Anforderungen jedes Projekts gerecht werden.

La famiglia modulare Iris prevede una versione proiettore con diverse soluzioni di installazione (guida trifase, guida a bassa tensione, proiettore con apparecchiatura remota e opzione accostata). In tutte le opzioni, Iris offre la possibilità di scegliere tra 2 moduli con diverse potenze (6W, 12W, 18W) per adeguarsi alle esigenze di ogni progetto.

In allen Ausführungen ist Iris mit 5 verschiedenen Diffusoren erhältlich, mit denen die Silhouette und die Wahrnehmung der Leuchte verändert und an die Anforderungen jedes Projekts angepasst werden können. Die kegelförmigen, ovalen und zylindrischen Glasschirme sind ideal für eher dekorative Projekte, während die Ring- und Visual Comfort-Optionen besser zu technischen Umgebungen passen.

In tutte le sue versioni Iris offre la possibilità di scegliere tra 5 diffusori che cambiano la sagoma e la percezione della lampada, adattandola così alle esigenze di ogni progetto. Gli schermi di vetro, di forma conica, ovale e cilindrica, sono ideali per progetti più decorativi, mentre le opzioni anello e Comfort Visual sono perfette per ambienti più tecnici.

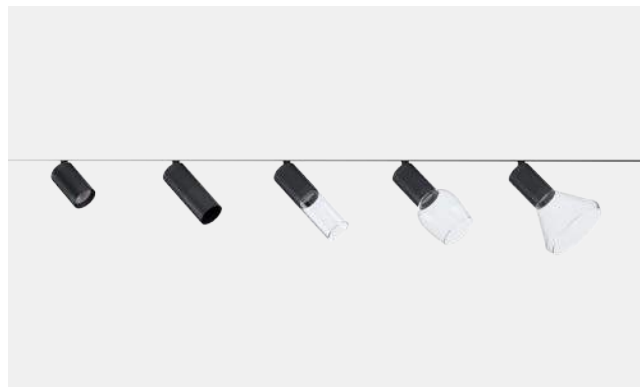

Vielfältiges Zubehör Varietà di accessori

Die Glasdiffusor-Optionen können mit 5 Zubehörteilen ergänzt werden, die das Licht entweder auf einen Punkt fokussieren oder streuen, um eine homogenere Raumwirkung zu erzielen. Bei den Ausführungen ohne Glasdiffusor können alle Zubehörteile außer dem Ring eingesetzt werden.

Le opzioni di diffusore in vetro possono essere completate da 5 accessori, che modulano la luce o per focalizzarla su un punto o per sfumarla e ottenere un effetto più omogeneo nello spazio. Nelle opzioni senza diffusore di vetro è possibile usare tutti gli accessori tranne l'anello.



Polycarbonatlinse Lente in policarbonato

Die Basis der Produktfamilie Iris enthält eine Polycarbonat-Linse mit 3 verschiedenen Öffnungen, um das Licht ohne Abweichungen scharf und präzise projizieren zu können.

Il nucleo di Iris integra una lente in policarbonato con 3 diverse aperture in grado di proiettare la luce senza aberrazioni, in modo chiaro e preciso.



IRIS

Spotlight



Codebeispiel / Esempio di codice: AV11-P6V9U10S60

Model	W	K/ CRI/ Real lm	Shade	Optics	Source	Finishes	
 <p>AV11 - Strahler / Mit Rahmen Proiettori / Trim Ⓢ 57</p> <p>Ø55</p> <p>Max. 120</p>  <p>Ø55</p>	P6 6W	V9 2700K/CRI90/ 692 lm	U Hoop	1 15°	OS  ON-OFF/ 220-240V/ 50-60Hz	60 ●	
		W9 3000K/CRI90/ 692 lm	V Visual Comfort	2 35°			DS  DALI-2/ 110-277V/ 50-60Hz
		X9 4000K/CRI90/ 695 lm	X Cone	3 50°			
		12 12W	V9 2700K/CRI90/ 1181 lm	Y Glass			
			W9 3000K/CRI90/ 1181 lm	Z Pipe			
			X9 4000K/CRI90/ 1181 lm				
 <p>AV12 - Strahler / Randlos Proiettori / Trimless Ⓢ 57</p> <p>Ø55</p> <p>Max. 120</p>  <p>Ø55</p>	18 18W	V9 2700K/CRI90/ 1325 lm					
		W9 3000K/CRI90/ 1325 lm					
		X9 4000K/CRI90/ 1325 lm					
 <p>AV13 - Strahler / Deckenleuchten Proiettori / Plafoniere Ⓢ 57</p> <p>Ø69</p> <p>Max. 150</p>  <p>Ø55</p>							

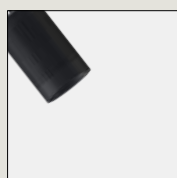

Hoop



Visual Comfort



Cone



Glass



Pipe

nicht inklusive / Non incluso



Wabenraster x 5 / Pannello a nido d'ape (5 unità)	71-5166-60-00
Elliptischer Diffusor x 5 / Diffusore ellittico (5 unità)	71-5167-00-00
5Weichzeichnerlinse x 5 / Sagomatore di fascio (5 unità)	71-6099-00-00
Schirm x 5 / Screen x 5	71-7894-60-00
Quadratischer Diffusor x 5 / Diffusore quadrato (5 unità)	71-5658-00-00

IRIS

Track

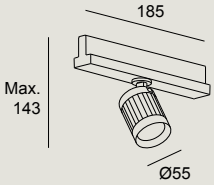

Codebeispiel / Esempio di codice: AV21-P6V9U10S60

Model	W	K/ CRI/ Real lm	Shade	Optics	Source	Finishes	
 	P6 6W	V9 2700K/CRI90/ 692 lm	U Hoop	1 15°	OS  ON-OFF/ 220-240V/ 50-60Hz	60 ●	
		W9 3000K/CRI90/ 692 lm	V Visual Comfort	2 35°			DS  DALI-2/ 220-240V/ 50-60Hz
		X9 4000K/CRI90/ 695 lm	X Cone	3 50°			
	12 12W	V9 2700K/CRI90/ 1181 lm	Y Glass				
		W9 3000K/CRI90/ 1181 lm	Z Pipe				
		X9 4000K/CRI90/ 1181 lm					
	18 18W	V9 2700K/CRI90/ 1325 lm					
		W9 3000K/CRI90/ 1325 lm					
		X9 4000K/CRI90/ 1325 lm					



Hoop



Visual Comfort



Cone



Glass



Pipe

nicht inklusive / Non incluso



Wabenraster x 5 / Pannello a nido d'ape (5 unità)	71-5166-60-00
Elliptischer Diffusor x 5 / Diffusore ellittico (5 unità)	71-5167-00-00
5Weichzeichnerlinse x 5 / Sagomatore di fascio (5 unità)	71-6099-00-00
Schirm x 5 / Screen x 5	71-7894-60-00
Quadratischer Diffusor x 5 / Diffusore quadrato (5 unità)	71-5658-00-00

IRIS

Low Voltage

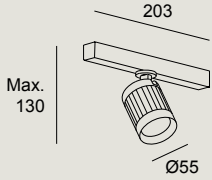

Codebeispiel / Esempio di codice: AV19-P6V9U10S60

Model	W	K/ CRI/ Real lm	Shade	Optics	Source	Finishes	
 	P6 6W	V9 2700K/CRI90/ 692 lm	U Hoop	1 15°	OS  ON-OFF/ 48 VDC	60 ●	
		W9 3000K/CRI90/ 692 lm	V Visual Comfort	2 35°	DS  DALI/ 48 VDC		
		X9 4000K/CRI90/ 695 lm	X Cone	3 50°			
	12 12W	V9 2700K/CRI90/ 1181 lm	Y Glass				
		W9 3000K/CRI90/ 1181 lm	Z Pipe				
		X9 4000K/CRI90/ 1181 lm					
	18 18W	V9 2700K/CRI90/ 1325 lm					
		W9 3000K/CRI90/ 1325 lm					
		X9 4000K/CRI90/ 1325 lm					

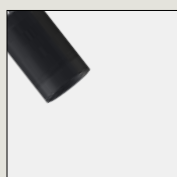

Hoop

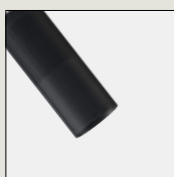

Visual Comfort



Cone



Glass



Pipe

nicht inklusive / Non incluso

Wabenraster x 5 / Pannello a nido d'ape (5 unità)	71-5166-60-00
Elliptischer Diffusor x 5 / Diffusore ellittico (5 unità)	71-5167-00-00
5Weichzeichnerlinse x 5 / Sagomatore di fascio (5 unità)	71-6099-00-00
Schirm x 5 / Screen x 5	71-7894-60-00
Quadratischer Diffusor x 5 / Diffusore quadrato (5 unità)	71-5658-00-00

Smart Compatible-Zub. / Access. Smart Compatibile

71-8115-00-00 Dimmer DALI Casambi



Tak

BODY MAT	DIF MAT		50000h	2
AL	PC		L80 B20	MacAdam



Kompaktes Design Design compatto

Bei der Strahlerkollektion Tak verbinden sich Stil und Funktionalität. Diese Kollektion mit kompaktem Design ist nur in einer Größe, jedoch in zwei Ausführungen, drei Winkeln und zwei Farbtemperaturen erhältlich. Mit dieser Auswahl kann die Beleuchtung an die Bedürfnisse jedes Projekts angepasst werden. Der Adapter der Leuchte ist optisch in die Schiene integriert.

Tak è una collezione di proiettori dove convergono stile e funzionalità. Con un design compatto, è disponibile in una sola misura, due finiture, 3 angoli e 2 temperature di colore, che permettono di adattare l'illuminazione alle esigenze di ogni progetto. Il driver, incluso nell'apparecchio di illuminazione, è integrato nel binario.

Der Strahler hat ein kompaktes Gehäuse und schlichtes Design, sodass er in jedem kommerziell genutzten Raum eingesetzt werden kann.

Il proiettore è dotato di una struttura compatta ed un design pulito che consente la sua installazione in qualsiasi spazio commerciale.



Hoher visueller Komfort Alto comfort visivo

Das Design und die zurückversetzte Optik von Tak gewährleisten einen hohen Sehkomfort und eine perfekte Farbwiedergabe, weshalb sie besonders für die Beleuchtung von Einzelhandels-, Ausstellungs- und Museumsräumen empfohlen wird.

Il design e la disposizione affondata dell'ottica di Tak garantiscono un elevato comfort visivo ed una perfetta riproduzione cromatica. Questo modello è particolarmente consigliato nell'illuminazione di spazi retail, espositivi e di musei.



Wärmeableitung Dissipazione termica

Tak ist eine kompakte Leuchte mit hervorragender Wärmeableitung, was die Lebensdauer der Leuchte und die Energieeffizienz erhöht.

Tak è un apparecchio di illuminazione compatto che soddisfa un'eccellente dissipazione termica e massimizza la durata dell'apparecchio, offrendo una maggior efficienza energetica.

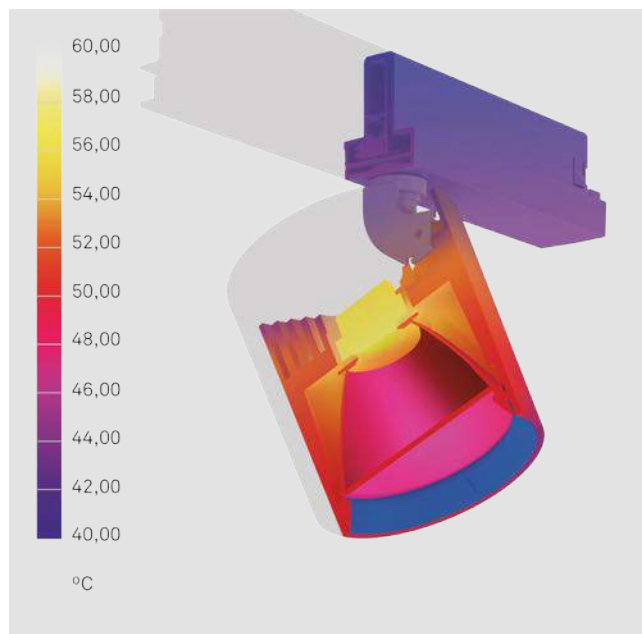

TAK



14

60

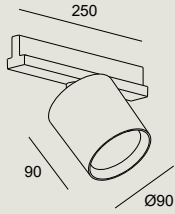

LED									
K	CRI	W LED	W Total	Real Lm	Optics	Code			
3000	90	31.1	32.8	2893	Spot 15°	35-A054	14	-	OS
3000	90	31.1	32.8	2849	Medium 26°	35-A055	60	-	DS
3000	90	31.1	32.8	2813	Flood 54°	35-A056	60	-	DS
4000	90	31.1	32.8	2937	Spot 15°	35-A057	14	-	OS
4000	90	31.1	32.8	2892	Medium 26°	35-A058	60	-	DS
4000	90	31.1	32.8	2856	Flood 54°	35-A059	60	-	DS

	OS	ON-OFF	220-240V	50-60Hz
	DS	DALI-2	220-240V	50-60Hz

nicht inklusive / Non incluso

Wabenraster
Pannello a nido d'ape

71-A177-60-00

Smart Compatible-Zub. / Access. Smart Compatibile

71-A243-14-14 Converter Casambi DALI Track White

71-A243-60-60 Converter Casambi DALI Track Black



Track

BODY MAT
AL



Track ist die Schienenkollektion von LEDS C4. Die Standard- und Euro Dali-Versionen sind in diversen Optionen erhältlich. Das Portfolio zeichnet sich durch seine Vielseitigkeit und Variantenvielfalt aus.

Track è la collezione di binari di LEDS C4. Nelle versioni Standard e Euro Dali si presentano con varie opzioni, tutte con una grande versatilità e con la possibilità di diverse composizioni.

TRACK STANDARD

Unsere Track gibt es in einer Trim- und einer Trimless-Ausführung als Auf- und Unterputzversion sowie in den Farben Schwarz und Weiß. Die Schienen sind vielseitig einsetzbar und passen sich dank ihrer Variantenvielfalt in Verbindung mit dem erhältlichen Zubehör wie L-, X- und T-Verbindungsstücken allen Räumen an. Zusätzlich sind dekorative Endkappen, flexible Schienenverbinde sowie weitere Befestigungssätze und Zubehörteile im Programm.

Track è disponibile nelle versioni Trim e Trimless con opzione ad incasso e in superficie, con finiture in bianco e nero. È un pezzo versatile che si adatta a tutti gli spazi grazie alla possibilità di effettuare diverse composizioni, utilizzando connettori di collegamento destro e sinistro, connettore a forma di X e connettori a forma di L e T, collegamento destro e sinistro. I binari includono anche un cappuccio decorativo, un connettore flessibile, di continuità e per binario, nonché altri kit di fissaggio e accessori.

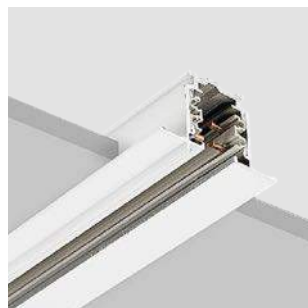

Kombinationsmöglichkeiten Possibilità di combinazione

Die Möglichkeiten der Zusammenstellung mit oder ohne Rahmen folgen einem Schema aus verschiedenen vorgeschlagenen Verbindungselementen.

Le possibilità di composizione con o senza cornice seguono uno schema di composizione mediante codici di riferimento, con diversi connettori proposti.

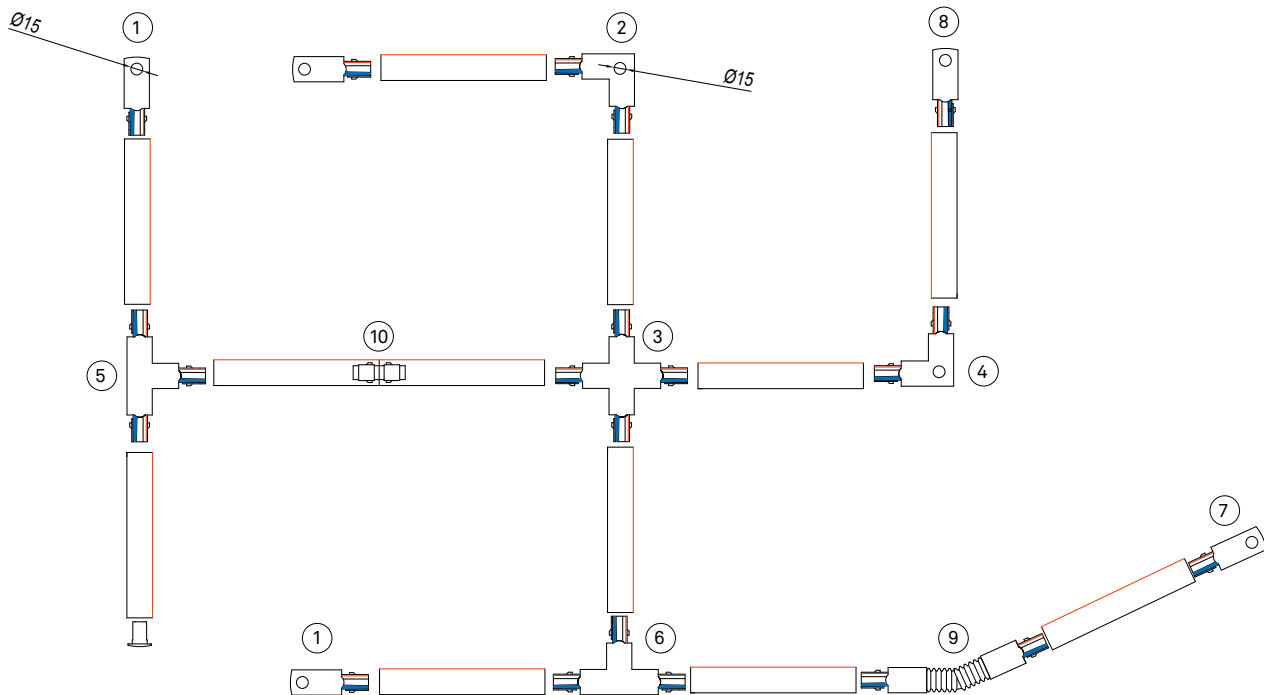

TRIMLESS

- ① 71-5214 
- ② 71-5219 
- ③ 71-5231 
- ④ 71-5220 
- ⑤ 71-5227 
- ⑥ 71-5228 
- ⑦ 71-5215 

TRIM

- ① 71-5216 
- ② 71-5221 
- ③ 71-5232 
- ④ 71-5222 
- ⑤ 71-5229 
- ⑥ 71-5230 
- ⑦ 71-5217 

TRIMLESS & TRIM

- ① 71-5218 
- ② 71-5223 
- ③ 71-5224 

TRACK EURO DALI

Die Aufputz- und Pendelversion der Euro-Dali-Schiene sind in den Farben Schwarz und Weiß erhältlich und bieten diverse Steuerungsmöglichkeiten.

Track Euro Dali, disponibile in versione da parete ed in sospensione, con finiture in bianco e nero, è l'opzione di collegamento per il binario, con diverse opzioni di connettività.

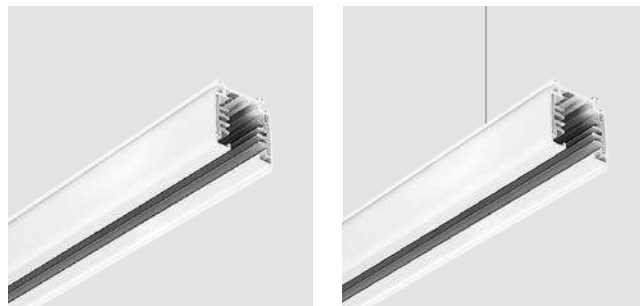

Kombinationsmöglichkeiten Possibilità di combinazioni

Die Möglichkeiten der Zusammenstellung ohne Rahmen folgen einem Schema aus verschiedenen vorgeschlagenen Verbindungselementen.

Le possibilità di composizione senza cornice seguono uno schema di composizione mediante codici, con diverse offerte di connettori.

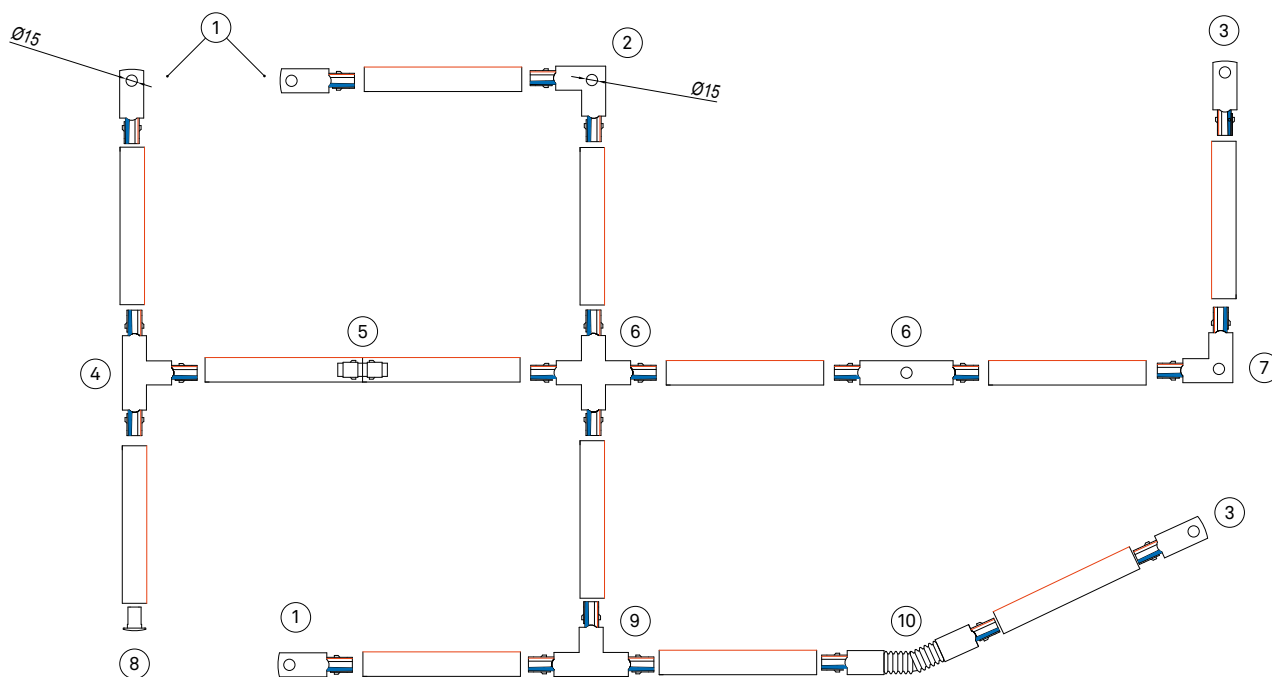



TRIMLESS

- | | | |
|---|---|---|
| ① 71-5538  | ⑥ 71-7541  | ⑩ 71-7547  |
| ② 71-7542  | ⑦ 71-7543  | |
| ③ 71-7539  | ⑧ 71-7537  | |
| ④ 71-7544  | ⑨ 71-7545  | |
| ⑤ 71-7540  | | |





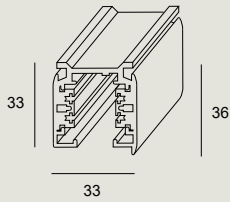

TRACK

Track Trimless

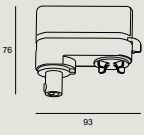
14  60 

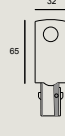

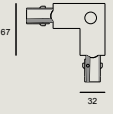
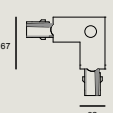
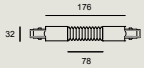
mm	Code
2000	71-5210 - 14 - 00
3000	71-5211 - 60 - 00

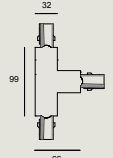
Anschlusszubehör nicht inbegriffen / Accessori di connessione non inclusi		
	Anschluss Weiß für Verbindung mit Hängeleuchten an Schienensystem Connettore bianco per il collegamento delle sospensioni su binario	71-2232-14-14
	Anschluss Schwarz für Verbindung mit Hängeleuchten an Schienensystem Connettore nero per il collegamento delle sospensioni su binario	71-2232-60-60
	Steckverbinder links in Weiß ohne Rahmen Connettore sinistro bianco senza cornice	71-5214-14-00
	Steckverbinder links in Schwarz ohne Rahmen Connettore sinistro nero senza cornice	71-5214-60-00
	Steckverbinder rechts in Weiß ohne Rahmen Connettore destro bianco senza cornice	71-5215-14-00
	Steckverbinder rechts in Schwarz ohne Rahmen Connettore destro nero senza cornice	71-5215-60-00
	Endkappe Weiß Tappo finale bianco	71-5218-14-00
	Endkappe Schwarz Tappo finale nero	71-5218-60-00
	L-Steckverbinder links in Weiß ohne Rahmen Connettore sinistro bianco L senza cornice	71-5219-14-00
	L-Steckverbinder links in Schwarz ohne Rahmen Connettore sinistro nero L senza cornice	71-5219-60-00
	L-Steckverbinder rechts in Weiß ohne Rahmen Connettore destro bianco L senza cornice	71-5220-14-00
	L-Steckverbinder rechts in Schwarz ohne Rahmen Connettore destro nero L senza cornice	71-5220-60-00
	Flexibler Steckverbinder Weiß Connettore flessibile bianco	71-5223-14-00
	Flexibler Steckverbinder Schwarz für Schiene Connettore flessibile nero binario	71-5223-60-00
	Durchgangs-Steckverbinder Weiß für Schiene Connettore continuità Bianco per binario	71-5224-14-00
	Durchgangs-Steckverbinder Schwarz für Schiene Connettore continuità nero per binario	71-5224-60-00
	T-Steckverbinder links in Weiß ohne Rahmen Connettore sinistro bianco T senza cornice	71-5227-14-00
	T-Steckverbinder links in Schwarz ohne Rahmen Connettore sinistro nero T senza cornice	71-5227-60-00



Anschlusszubehör nicht inbegriffen / Accessori di connessione non inclusi		
	T-Steckverbinder rechts in Weiß ohne Rahmen Connettore destro bianco T senza cornice	71-5228-14-00
	T-Steckverbinder rechts in Schwarz ohne Rahmen Connettore destro nero T senza cornice	71-5228-60-00
	X-Steckverbinder Weiß ohne Rahmen Connettore bianco X senza cornice	71-5231-14-00
	X-Steckverbinder Schwarz ohne Rahmen Connettore nero X senza cornice	71-5231-60-00

Befestigungselemente und Zubehör nicht inbegriffen / Elementi di fissaggio e accessori non inclusi		
Zubehör für direkte Befestigung an Zwischendecken in Weiß Accessorio bianco fissaggio diretto controsoffitti	71-5225-14-00	
Zubehör für direkte Befestigung an Zwischendecken in Schwarz Accessorio nero fissaggio diretto controsoffitti	71-5225-60-00	
Hänge-Fleuron mit Stromanschluss Weiß Rosone sospeso presa di corrente bianco	71-7520-14-00	
Hänge-Fleuron mit Stromanschluss Schwarz Rosone sospeso presa di corrente nero	71-7520-60-00	
Hänge-Fleuron mit Stromanschluss Grau Rosone sospeso presa di corrente grigio	71-7520-N3-00	
Stahlkabel + Abhängklammer Weiß Cavo d'acciaio + clip sospensione bianco	71-7656-14-00	
Stahlkabel + Abhängklammer Schwarz Cavo d'acciaio + clip sospensione nero	71-7656-60-00	



TRACK



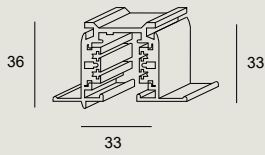

Track Trim

14  60 

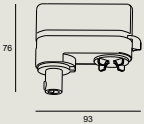
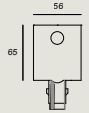
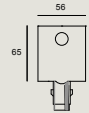

mm	Code
2000	71-5213 - ¹⁴ / ₆₀ - 00

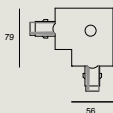
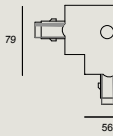
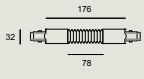
Anschlusszubehör nicht inbegriffen / Accessori di connessione non inclusi

	Anschluss Weiß für Verbindung mit Hängeleuchten an Schienensystem Connettore bianco per il collegamento delle sospensioni su binario	71-2232-14-14
	Anschluss Schwarz für Verbindung mit Hängeleuchten an Schienensystem Connettore nero per il collegamento delle sospensioni su binario	71-2232-60-60
	Steckverbinder links in Weiß mit Rahmen Connettore sinistro bianco con cornice	71-5216-14-00
	Steckverbinder links in Schwarz mit Rahmen Connettore sinistro nero con cornice	71-5216-60-00
	Steckverbinder rechts in Weiß mit Rahmen Connettore destro bianco con cornice	71-5217-14-00
	Steckverbinder rechts in Schwarz mit Rahmen Connettore destro nero con cornice	71-5217-60-00
	Endkappe Weiß Tappo finale bianco	71-5218-14-00
	Endkappe Schwarz Tappo finale nero	71-5218-60-00
	L-Steckverbinder links in Weiß mit Rahmen Connettore sinistro bianco L con cornice	71-5221-14-00
	L-Steckverbinder links in Schwarz mit Rahmen Connettore sinistro nero L con cornice	71-5221-60-00
	L-Steckverbinder rechts in Weiß mit Rahmen Connettore destro bianco L con cornice	71-5222-14-00
	L-Steckverbinder rechts in Schwarz mit Rahmen Connettore destro nero L con cornice	71-5222-60-00
	Flexibler Steckverbinder Weiß Connettore flessibile bianco	71-5223-14-00
	Flexibler Steckverbinder Schwarz für Schiene Connettore flessibile nero binario	71-5223-60-00
	Durchgangs-Steckverbinder Weiß für Schiene Connettore continuità Bianco per binario	71-5224-14-00
	Durchgangs-Steckverbinder Schwarz für Schiene Connettore continuità nero per binario	71-5224-60-00

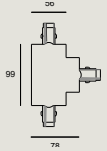
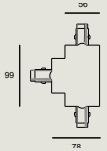
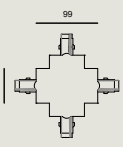
Anschlusszubehör nicht inbegriffen / Accessori di connessione non inclusi		
	T-Steckverbinder links in Weiß mit Rahmen Connettore sinistro bianco T con cornice	71-5229-14-00
	T-Steckverbinder links in Schwarz mit Rahmen Connettore sinistro nero T con cornice	71-5229-60-00
	T-Steckverbinder rechts in Weiß mit Rahmen Connettore destro bianco T con cornice	71-5230-14-00
	T-Steckverbinder rechts in Schwarz mit Rahmen Connettore destro nero T con cornice	71-5230-60-00
	X-Steckverbinder Weiß mit Rahmen Connettore bianco X con cornice	71-5232-14-00
	X-Steckverbinder Schwarz mit Rahmen Connettore nero X con cornice	71-5232-60-00

Befestigungselemente und Zubehör nicht inbegriffen / Elementi di fissaggio e accessori non inclusi		
Zubehör für direkte Befestigung an Zwischendecken in Weiß Accessorio bianco fissaggio diretto controsoffitti	71-5225-14-00	
Zubehör für direkte Befestigung an Zwischendecken in Schwarz Accessorio nero fissaggio diretto controsoffitti	71-5225-60-00	
Hänge-Fleuron mit Stromanschluss Weiß Rosone sospeso presa di corrente bianco	71-7520-14-00	
Hänge-Fleuron mit Stromanschluss Schwarz Rosone sospeso presa di corrente nero	71-7520-60-00	
Hänge-Fleuron mit Stromanschluss Grau Rosone sospeso presa di corrente grigio	71-7520-N3-00	
Stahlkabel + Abhängklammer Weiß Cavo d'acciaio + clip sospensione bianco	71-7656-14-00	
Stahlkabel + Abhängklammer Schwarz Cavo d'acciaio + clip sospensione nero	71-7656-60-00	

TRACK

Track Euro Dali



14 60

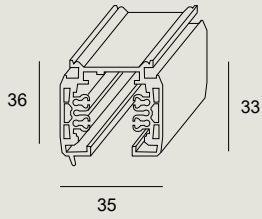

mm	Code
1000	71-7534
2000	71-7535 - 14 - 00
3000	71-7536 - 60 - 00

Anschlusszubehör nicht inbegriffen / Accessori di connessione non inclusi		
	Endkappe Weiß Tappo finale bianco	71-7537-14-00
	Endkappe Schwarz Tappo finale nero	71-7537-60-00
	Steckverbinder links in Weiß DALI Connettore sinistro bianco DALI	71-7538-14-00
	Steckverbinder links in Schwarz DALI Connettore sinistro nero DALI	71-7538-60-00
	Steckverbinder rechts in Weiß DALI Connettore destro bianco DALI	71-7539-14-00
	Steckverbinder rechts in Schwarz DALI Connettore destro nero DALI	71-7539-60-00
	Mini-I-Steckverbinder Weiß DALI Mini connettore I bianco DALI	71-7540-14-00
	Mini-I-Steckverbinder Schwarz DALI Mini connettore I nero DALI	71-7540-60-00
	I-Steckverbinder Weiß DALI Connettore I bianco DALI	71-7541-14-00
	I-Steckverbinder Schwarz DALI Connettore I nero DALI	71-7541-60-00
	L-Steckverbinder links in Weiß DALI Connettore sinistro bianco L DALI	71-7542-14-00
	L-Steckverbinder links in Schwarz DALI Connettore sinistro nero L DALI	71-7542-60-00
	L-Steckverbinder rechts in Weiß DALI Connettore destro L bianco DALI	71-7543-14-00
	L-Steckverbinder rechts in Schwarz DALI Connettore destro L nero DALI	71-7543-60-00
	T-Steckverbinder links in Schwarz DALI Connettore sinistro bianco T DALI	71-7544-14-00
	T-Steckverbinder links in Schwarz DALI Connettore sinistro nero T DALI	71-7544-60-00
	T-Steckverbinder rechts in Weiß DALI Connettore destro T bianco DALI	71-7545-14-00
	T-Steckverbinder rechts in Schwarz DALI Connettore destro T nero DALI	71-7545-60-00

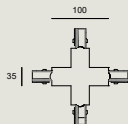
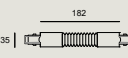
Anschlusszubehör nicht inbegriffen / Accessori di connessione non inclusi		
	X-Steckverbinder Schwarz DALI Connettore X bianco DALI	71-7546-14-00
	X-Steckverbinder Schwarz DALI Connettore X nero DALI	71-7546-60-00
	Flexibler Steckverbinder Weiß DALI Connettore flessibile bianco DALI	71-7547-14-00
	Flexibler Steckverbinder Schwarz DALI Connettore flessibile nero DALI	71-7547-60-00

Smart Compatible-Zub. / Access. Smart Compatibile	
35-A076-14-00	Multisensor D4i Connected Track White
35-A076-60-00	Multisensor D4i Connected Track Black
71-A243-14-14	Converter Casambi DALI Track White
71-A243-60-60	Converter Casambi DALI Track Black

Befestigungselemente und Zubehör nicht inbegriffen / Elementi di fissaggio e accessori non inclusi	
Hänge-Fleuron mit Stromanschluss DALI Weiß Rosone sospeso presa di corrente DALI bianco	71-7521-14-00
Hänge-Fleuron mit Stromanschluss DALI Schwarz Rosone sospeso presa di corrente DALI nero	71-7521-60-00
Stahlkabel + Abhängklammer Weiß Cavo d'acciaio + clip sospensione bianco	71-7656-14-00
Stahlkabel + Abhängklammer Schwarz Cavo d'acciaio + clip sospensione nero	71-7656-60-00
Zubehör für direkte Befestigung an Zwischendecken in Weiß Accessorio bianco fissaggio diretto controsoffitti	71-8197-14-00
Zubehör für direkte Befestigung an Zwischendecken in Schwarz Accessorio nero fissaggio diretto controsoffitti	71-8197-60-00

LV

Niederspannung Bassa tensione

 <p>Atom Low Voltage 127</p>	 <p>Kiva Low Voltage 127</p>	 <p>Iris Low Voltage 128</p>	 <p>Bento Low Voltage 128</p>	 <p>Infinite Low Voltage 129</p>
 <p>Vela Low Voltage 129</p>	 <p>Punto Low Voltage 130</p>	 <p>Veneto Low Voltage 130</p>	 <p>Track Low Voltage 131</p>	



Low Voltage

Ein multifunktionales System mit einer Spannung von 48V, das auf der Kombination eines magnetischen Profils mit verschiedenen Beleuchtungslösungen (Strahler, Pendel- und Linearleuchten) basiert. Es kann vertikal und horizontal montiert werden, zudem gibt es Unterputz-, Aufputz- und Pendelversionen. Das Low Voltage-System bietet Designern großen Spielraum. Durch das Einstellen und Verschieben der Lichtquellen kann diese Beleuchtung für verschiedenste Arten von Räumen eingesetzt werden und sich an vielseitige Räume anpassen. Darüber hinaus verfügt es über das optische Kontrollsystem OPTI LENS, das den Restlichthof reduziert und dem Projekt eine höhere Beleuchtungseffizienz verleiht.

Sistema multiuso basato sulla combinazione di un profilo magnetico, alimentato a 48V, e diverse soluzioni di illuminazione come proiettori, sospensioni e prodotti lineari. Può essere installato in verticale o in orizzontale e viene offerto nelle versioni per l'installazione ad incasso, da superficie e come sospensione. Il sistema Low Voltage offre al progettista grande libertà, potendo illuminare spazi mutevoli e versatili, regolando e spostando i punti luce per adattarli alle esigenze di ogni momento. Dispone, inoltre, di un sistema di controllo ottico OPTI LENS che riduce l'alone residuo, fornendo una maggiore efficienza luminosa al progetto.

Atom
P. 127



30 mm



52 mm

Kiva
P. 127



75 mm



95 mm

Iris
P. 128



55 mm

Bento
P. 128



99 mm



194 mm

3,1 - 12,1 W



Ultra Spot - Ultra Flood
8° - 43°

14 ○ 60 ● 81 ● DN ●



6,4 - 12 W



Ultra Medium 24°

14 ○ 60 ● 81 ● DN ●



6 - 18 W



Extra Spot - Ultra Flood
15° - 50°

60 ●



6 - 12 W



Ultra Medium 25°

14 ○ 60 ●



Infinite
P. 129



494 mm



988 mm

6,5 - 13 W



Flood 92°

60 ●



Vela
P. 129



3,1 W



Ultra Medium 24°

60 ● 81 ● DN ●



Punto
P. 130

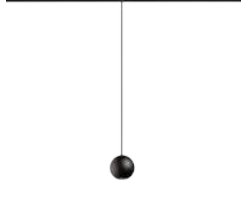

5 W



Medium 35°

14 ○ 60 ●

Veneto
P. 130



5 W

05 ● DO ●

Track
P. 131



Surface



Pendant

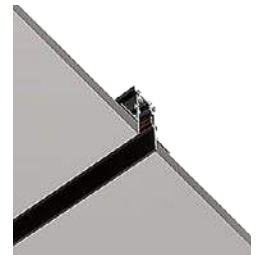

Recessed



Up&Down

14 ○ 60 ●



Smart

Die in den Kollektionen Atom LV, Kiva LV, Bento LV und Vela LV verbauten Casambi Bluetooth Mesh-Technologie ermöglicht die individuelle Steuerung der einzelnen Leuchten, wodurch auf präzisere Weise verschiedene Stimmungen erzeugt werden können. La tecnologia Casambi Bluetooth Mesh è incorporata nelle collezioni Atom LV, Kiva LV, Bento LV e Vela LV e permette il controllo individuale di ciascuno di questi apparecchi facilitando, in questo modo, la creazione di atmosfere più precise.

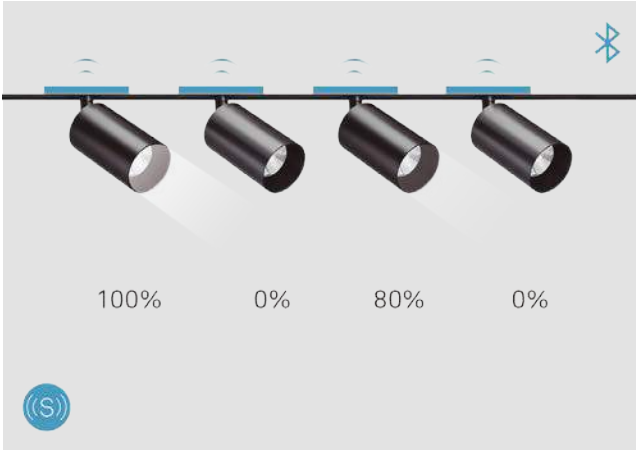

Smart Compatible

Zudem verfügt sie über Smart Compatible-Konnektivität über das Casambi-Zubehör für die Niederspannungsschiene, die die Steuerung von DALI-Leuchten ermöglicht, die an die Schiene angeschlossen sind, an die auch das Zubehör angeschlossen ist. Incorporano, inoltre, l'opzione di connettività Smart Compatible utilizzando l'accessorio Casambi su binario Low Voltage che consente di controllare gli apparecchi DALI che sono collegati al binario, qualora questo accessorio sia collegato.

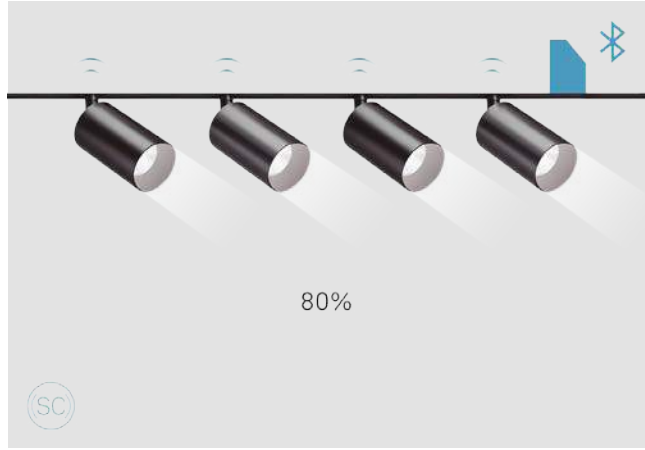

Smart-Funktionen:
Energieeinsparung oder
Lichtatmosphären
Funzionalità Smart:
Risparmio energetico o
Atmosfere luminose



Video ansehen
Guarda il video



Die Kollektion Low Voltage ermöglicht es, Lichtstimmungen zu erzeugen und mit verschiedenen Szenen auf derselben Leuchtenschiene zu experimentieren, ohne dass eine komplexe Installation erforderlich ist. La collezione Low Voltage consente di creare atmosfere luminose e di giocare con varie scene sullo stesso binario di luci, senza dover realizzare un impianto complesso.

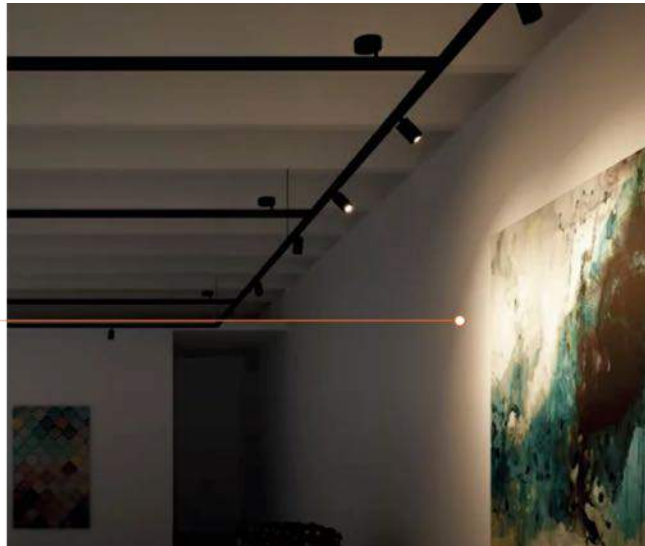

ATOM LOW VOLTAGE

BODY MAT		50000h
AL		L80 B20

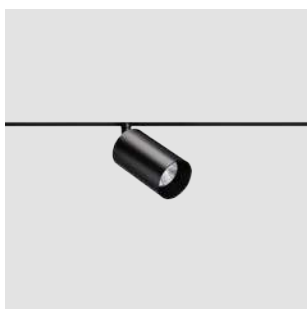

Der Niedervoltstrahler Atom Low Voltage ermöglicht eine in den Raum integrierte Beleuchtung dank der Verkleinerung der Leuchte und einer breiten Palette von Essence Ausführungen. Als Neuheit bietet die Variante in der Größe 52 mm die Möglichkeit, den optischen Winkel von Extra Spot (16°) bis Ultra Flood (47°) manuell einzustellen. Als DALI- und Casambi-Variante erhältlich.

Il proiettore Atom Low Voltage permette un'illuminazione integrata nello spazio grazie alla miniaturizzazione del pezzo e ad un'ampia disponibilità di finiture Essence. Come novità, la misura 52 offre la possibilità dello zoom manuale che permette di regolare l'angolo ottico dall'apertura Extra Spot (16°) a quella Ultra Flood (47°). Disponibile in versione DALI e Casambi.



KIVA LOW VOLTAGE

BODY MAT		50000h	2
AL		L80 B20	MacAdam



Ausgezeichnete optische Lichtlenkung in einem eleganten, ultrakompakten Strahler-Design. Als DALI- und Casambi-Variante erhältlich.

Eccellente controllo ottico in un proiettore che è dotato di un design pulito ed ultracompatto. Disponibile in versione DALI e Casambi.



IRIS LOW VOLTAGE

BODY MAT		50000h	2
AL		L80 B20	MacAdam

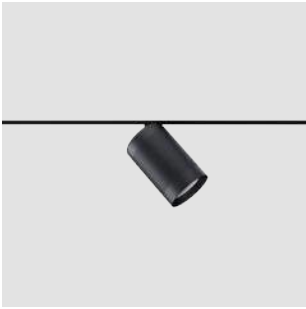

In der Version Low Voltage mit bis zu 18 W bieten die Strahler der Produktfamilie Iris eine modulare Beleuchtung, die dank der Auswahl zwischen 5 verschiedenen Abdeckungen, die das Erscheinungsbild der Leuchte völlig verändern, hervorragend in den Raum integriert und an die Bedürfnisse jedes Projekts angepasst werden kann.

Nell'opzione Low Voltage, nelle versioni fino a 18W, il proiettore Iris offre un'illuminazione modulare che si integra nello spazio grazie alla possibilità di scegliere tra 5 differenti diffusori, che cambiano completamente la percezione dell'apparecchio, adattandosi così alle esigenze di ogni progetto.

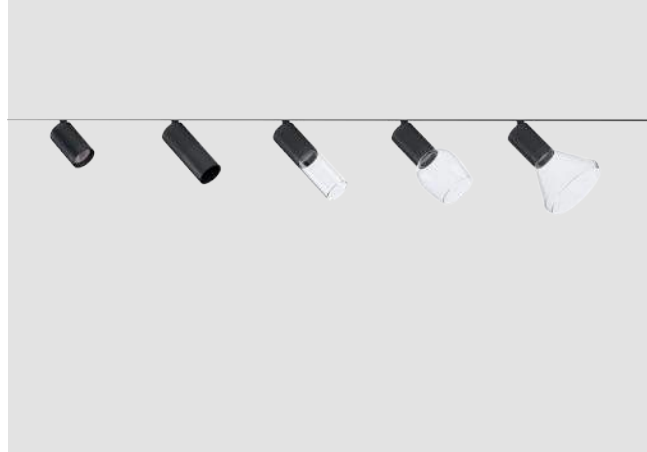

BENTO LOW VOLTAGE

BODY MAT		50000h	3
PC,AL		L80 B20	MacAdam



Erhältlich in zwei linearen Versionen mit 6 und 12 LEDs. Bento Low Voltage vereint das Wesentliche der Bento-Kollektion und bietet eine ausgezeichnete optische Lenkung des Lichts und einen Dark-Light-Effekt sowie die Flexibilität der Niederspannungsstromversorgung. Als DALI- und Casambi-Variante erhältlich.

Disponibile in due versioni lineari di 6 e 12 punti luce. Bento Low Voltage riunisce l'essenza della collezione Bento, offrendo un eccellente controllo ottico ed un effetto Dark Light, a cui si aggiunge la flessibilità del sistema di alimentazione a bassa tensione. Disponibile in versione DALI e Casambi.



INFINITE LOW VOLTAGE

DIF MAT		50000h	3
PVC		L80 B20	MacAdam

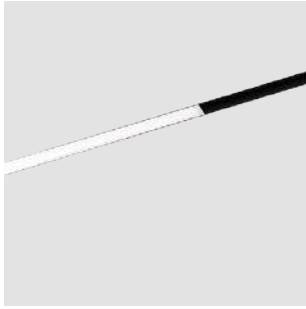

Eine in die Niederspannungsschiene integrierte geradlinige und gleichmäßige Beleuchtung, erhältlich in zwei linearen Einheiten mit unterschiedlicher Größe.

Illuminazione lineare ed omogenea integrata nel binario a bassa tensione, disponibile in due sezioni lineari di misure diverse.

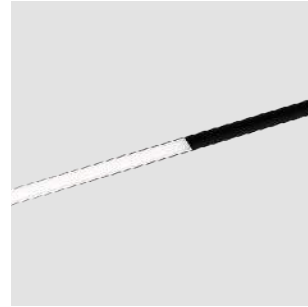

VELA LOW VOLTAGE

BODY MAT		50000h	2
AL		L80 B20	MacAdam

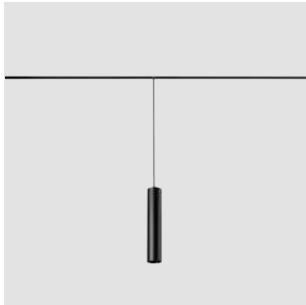

Magnetische und verstellbare Pendelleuchte mit Möglichkeit zur Integration in 48-V-Schienen. Erhältlich als DALI- und Casambi-Variante und in den Essence-Ausführungen.

Sospensione magnetica ed orientabile con l'integrazione su binari 48V e disponibile in versione DALI e Casambi e con finiture Essence.



PUNTO LOW VOLTAGE

BODY MAT		50000h	3
AL		L80 B20	MacAdam

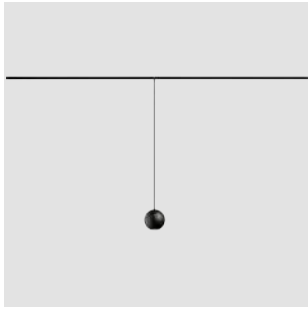

Zubehör inbegriffen
Accessorio incluso

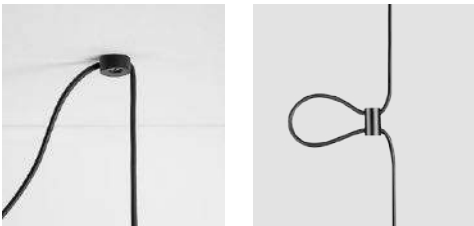

Magnetische und verstellbare Pendelleuchte mit Möglichkeit zur Integration in 48-V-Schienen und einem UGR-Wert von unter 13. Sospensione magnetica e regolabile con integrazione su binario 48V e con UGR < 13.



VENETO LOW VOLTAGE

BODY MAT	DIF MAT		50000h	3
PMMA,AL	PMMA		L80 B20	MacAdam



Zubehör inbegriffen
Accessorio incluso

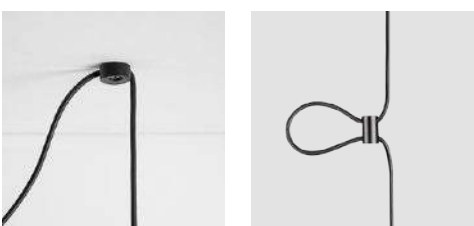

Magnetische und verstellbare Pendelleuchte mit Möglichkeit zur Integration in 48-V-Schienen. Erhältlich als DALI- und Casambi-Variante und in den Essence-Ausführungen. Sospensione magnetica ed orientabile con l'integrazione su binari 48V e disponibile in versione DALI e Casambi e con finiture Essence.



TRACK LOW VOLTAGE

BODY MAT
AL



Track ist das Schienensystem vom C4 LEDS. Ein vielseitiges Produkt, dass sich dank seiner Kompositionsmöglichkeiten an alle Räumlichkeiten anpasst. Die LOW VOLTAGE-Ausführung von Track ist ein mit 48 V gespeistes Schienenprofil, das mit verschiedenen Lösungen wie Strahlern, Pendel- und Linearleuchten ausgestattet werden kann.

Track è il binario di LEDS C4, un pezzo versatile che si adatta a tutti gli spazi grazie alle sue possibilità di composizione. Nella versione LOW VOLTAGE, Track è un binario alimentato a 48V, compatibile con varie soluzioni come proiettori, lampade a sospensione e lineari.

Options d'installation Ausführungen Varie finiture

Als Neuheit ist Track Low Voltage jetzt auch in weiß erhältlich. Somit kann künftig zwischen schwarz und weiß gewählt werden. Track Low Voltage presenta una nuova finitura in bianco, offrendo così la possibilità di scegliere tra finitura bianca o nera.

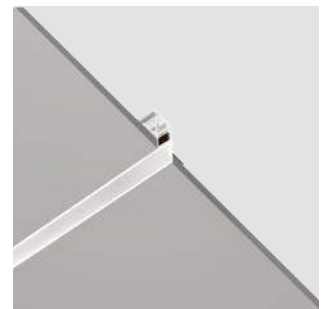
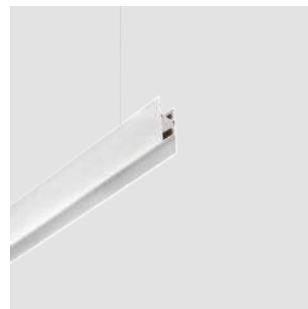
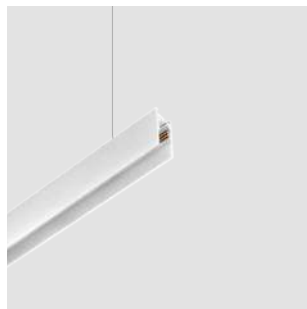
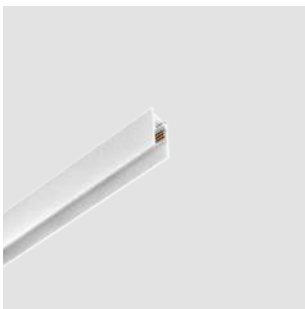
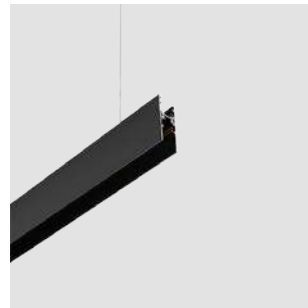
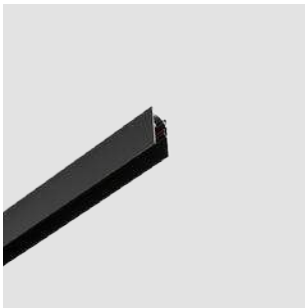

Surfaced

Pendant

Up & Down

Recessed

ATOM Low Voltage

IP	2	WELL	((S))	(SC)
20	MacAdam			

14  60  81  DN 

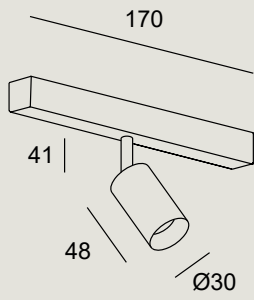

LED										
K	CRI	W LED	W Total	Real Lm	Optics	Code				
2700	90	3.1	4.6	269	Medium 37°	35-7285	14	00	-	-
							60	DA		
							81	XB		
							DN			
3000	90	3.1	4.6	269	Medium 37°	35-7286	14	00	-	-
							60	DA		
							81	XB		
							DN			
00	ON-OFF									
DA	DALI									
XB	Casambi									
 48 VDC										

Smart Compatible-Zub. / Access. Smart Compatibile
71-8115-00-00 Converter Casambi DALI Low Voltage

ATOM Low Voltage

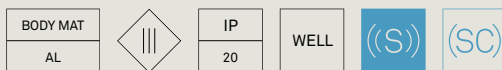

14 60 81 DN

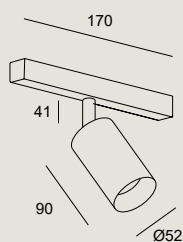

LED									
K	CRI	W LED	W Total	Real Lm	Optics	Code			
2700	90	8.5	10.2	428	Narrow 8°	35-A072	14	00	
2700	90	12.7	15	853	Medium 24°	35-7279	60	DA	
2700	90	12.7	15	928	Medium 32°	35-7280	81	XB	
2700	90	12.7	15	778	Flood 44°	35-7281	DN		
							14	00	
2700	90	12.7	15	518	Zoom 16-47°	35-A063	60	DA	
							14	00	
3000	90	8.5	10.2	437	Narrow 8°	35-A073	14	00	
3000	90	12.7	15	853	Medium 24°	35-7282	60	DA	
3000	90	12.7	15	928	Medium 32°	35-7283	81	XB	
3000	90	12.7	15	778	Flood 44°	35-7284	DN		
							14	00	
3000	90	12.7	15	551	Zoom 16-47°	35-A064	60	DA	
							14	00	
							60	DA	
							81	XB	
							DN		
ON-OFF DALI Casambi 48 VDC									

nicht inklusive / Non incluso	
5 x Wabenraster 5 x Pannello a nido d'ape	71-6273-60-00
5 x Elliptischer Diffusor 5 x Diffusore ellittico	71-6274-00-00
5 x Weichzeichnerlinse 5 x Sagomatore di fascio	71-6275-00-00
Visueller Komfort Weiß Comfort visivo bianco	71-6276-14-00
Visueller Komfort Schwarz Comfort visivo nero	71-6276-60-00
Blende Visiera	71-6277-60-00
Vorderring Weiß Anello frontale bianco	71-6436-14-00
Vorderring Gold Anello frontale dorato	71-6436-23-00

Smart Compatible-Zub. / Access. Smart Compatibile
71-8115-00-00 Converter Casambi DALI Low Voltage

LV

INDOOR NIEDERSpannung / BASSA TENSIONE

KIVA Low Voltage

UGR	(S)	(SC)
<16		

14 60 81 DN

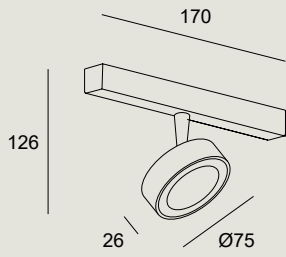

LED							
K	CRI	W LED	W Total	Real Lm	Optics	Code	
2700	90	6.4	8.1	458	Spot 19°	35-8035 -	14 00
						60 -	DA
						81 -	XB
						DN	
3000	90	6.4	8.1	530	Spot 19°	35-8036 -	14 00
						60 -	DA
						81 -	XB
						DN	

00 ON-OFF
 DA DALI
 XB Casambi

48 VDC

UGR	(S)	(SC)
<16		

14 60 81 DN

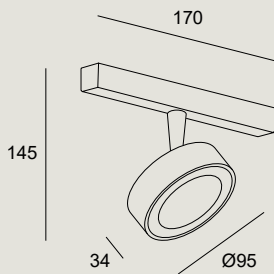

LED							
K	CRI	W LED	W Total	Real Lm	Optics	Code	
2700	90	12	16.8	1172	Medium 23°	35-8037 -	14 00
						60 -	DA
						81 -	XB
						DN	
3000	90	12	16.8	1320	Medium 23°	35-8038 -	14 00
						60 -	DA
						81 -	XB
						DN	



00 ON-OFF
 DA DALI
 XB Casambi

48 VDC

IRIS Low Voltage



Codebeispiel / Esempio di codice: AV19-P6V9U10S60

Model	W	K/ CRI/ Real lm	Shade	Optics	Source	Finishes		
 	P6 6W	V9 2700K/CRI90/ 692 lm	U Hoop	1 15°	OS  ON-OFF/ 48 VDC	60 		
		W9 3000K/CRI90/ 692 lm	V Visual Comfort	2 35°			DS  DALI/ 48 VDC	
		X9 4000K/CRI90/ 695 lm	X Cone	3 50°				
	12 12W	V9 2700K/CRI90/ 1181 lm	Y Glass					
		W9 3000K/CRI90/ 1181 lm	Z Pipe					
		X9 4000K/CRI90/ 1181 lm						
	18 18W	V9 2700K/CRI90/ 1325 lm						
		W9 3000K/CRI90/ 1325 lm						
		X9 4000K/CRI90/ 1325 lm						

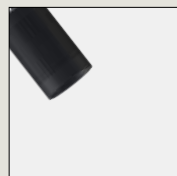

Hoop

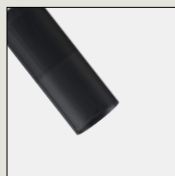

Visual Comfort



Cone



Glass



Pipe

nicht inklusive / Non incluso	
Wabenraster x 5 / Pannello a nido d'ape (5 unità)	71-5166-60-00
Elliptischer Diffusor x 5 / Diffusore ellittico (5 unità)	71-5167-00-00
5Weichzeichnerlinse x 5 / Sagomatore di fascio (5 unità)	71-6099-00-00
Schirm x 5 / Screen x 5	71-7894-60-00
Quadratischer Diffusor x 5 / Diffusore quadrato (5 unità)	71-5658-00-00

Smart Compatible-Zub. / Access. Smart Compatibile	
71-8115-00-00 Dimmer DALI Casambi	

LV

INDOOR NIEDERSpannung / BASSA TENSIONE

BENTO Low Voltage

UGR	WELL	(S)	(SC)
<10			

14 60

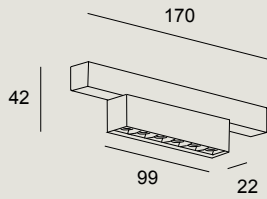

LED									
K	CRI	W LED	W Total	Real Lm	Optics	Code			
2700	90	6	8.1	594	Medium 26°	15-7885	- 14	-	00
2700	90	6	8.1	521	Flood 52°	15-A041	- 60	-	DA
									XB
3000	90	6	8.1	594	Medium 26°	15-7886	- 14	-	00
3000	90	6	8.1	521	Flood 52°	15-A042	- 60	-	DA
									XB
00 ON-OFF DA DALI XB CASAMBI									
48 VDC									

UGR	WELL	(S)	(SC)
<10			

14 60

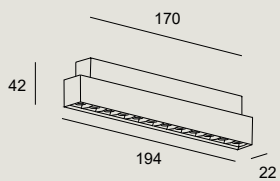

LED									
K	CRI	W LED	W Total	Real Lm	Optics	Code			
2700	90	12	13.5	1082	Medium 28°	15-7888	- 14	-	00
2700	90	12	13.5	1025	Flood 51°	15-A043	- 60	-	DA
									XB
3000	90	12	13.5	1082	Medium 28°	15-7889	- 14	-	00
3000	90	12	13.5	1025	Flood 51°	15-A044	- 60	-	DA
									XB
00 ON-OFF DA DALI XB CASAMBI									
48 VDC									

INFINITE Low Voltage

UGR	WELL	(SC)
<22		

60 ●

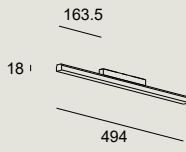

LED						
K	CRI	W LED	W Total	Real Lm	Code	
2700	90	6.5	7	654	90-7359 - 60 -	00 DA
3000	90	6.5	7	654	90-7361 - 60 -	00 DA
00 ON-OFF DA DALI 48 VDC						

UGR	WELL	(SC)
<22		

60 ●

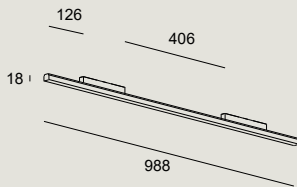

LED						
K	CRI	W LED	W Total	Real Lm	Code	
2700	90	13	13	1208	90-7360 - 60 -	00 DA
3000	90	13	13	1208	90-7362 - 60 -	00 DA
00 ON-OFF DA DALI 48 VDC						

LV

INDOOR NIEDERSpannung / BASSA TENSIONE

VELA Low Voltage

UGR	(S)	(SC)
<16		

60 ● 81 ● DN ●

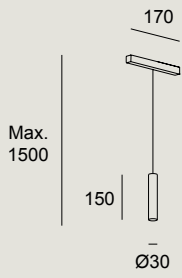

LED						
K	CRI	W LED	W Total	Real Lm	Code	
2700	90	3.1	4.6	269	00-7341 - 60 - DN	81 - DA - XB
3000	90	3.1	4.6	269	00-7342 - 60 - DN	81 - DA - XB

00 ON-OFF
DA DALI
XB Casambi

48 VDC

Smart Compatible-Zub. / Access. Smart Compatibile
71-8115-00-00 Converter Casambi DALI Low Voltage

PUNTO Low Voltage

UGR	
<13	ON-OFF

05 ● 14 ○

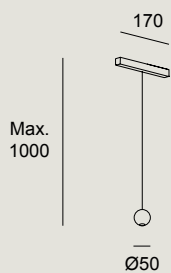

LED					
K	CRI	W LED	W Total	Real Lm	Code
3000	90	5	6.5	329	00-7906 - 05 14 - 00
48 VDC					

UGR	
<13	ON-OFF

05 ● 14 ○

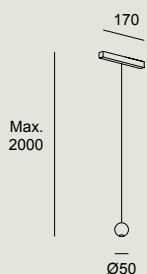

LED					
K	CRI	W LED	W Total	Real Lm	Code
3000	90	5	6.5	329	00-7907 - 05 14 - 00
48 VDC					

INDOOR NIEDERSpannung / BASSA TENSIONE

LV

mitgeliefertes allgemeines Zub. Deckenaufhängung zum Versetzen des Lichtpunktes
Access. comuni inclusi Decentratore a soffitto per spostare il punto luce

VENETO

Low Voltage

05 ●

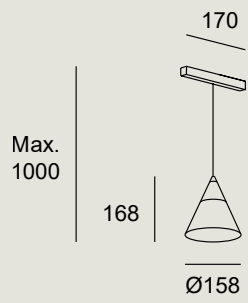

LED				
K	CRI	W LED	Real Lm	Code
2700	80	5	268	00-7592 - 05 - DO
48 VDC				

05 ●

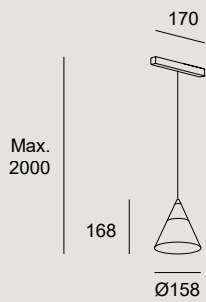

LED				
K	CRI	W LED	Real Lm	Code
2700	80	5	268	00-7593 - 05 - DO
48 VDC				





TRACK Low Voltage Surfaced

Installationsschema Schema di installazione

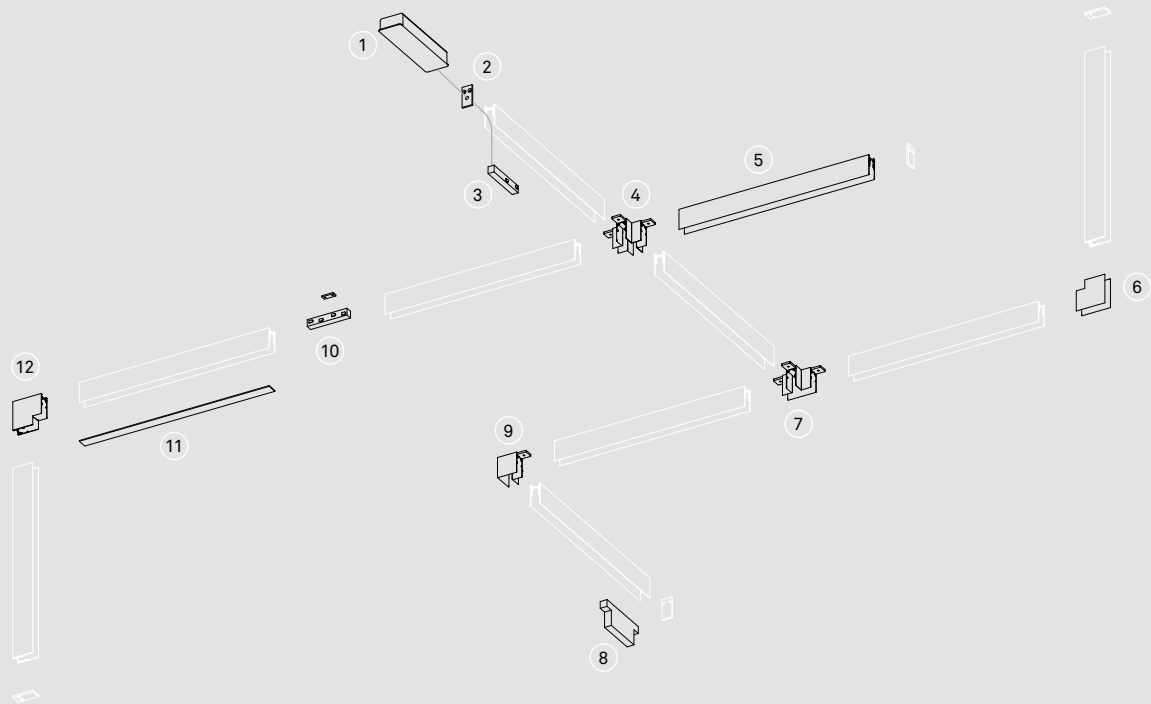

- | | | | |
|--|--|--|--|
| <p>① Power source
71-7646-00-00
(48V / 150W)
71-7647-00-00
(48V / 240W)
71-7648-00-00
(for DIN 48V / 240W track)
71-A258-00-00
(48V / 75W)
71-A259-00-00
(48V / 120W)</p> <p>② End cap
71-7705-00-00</p> <p>③ Power connector
71-7637-60-00</p> | <p>④ X joint
71-A247-60-00</p> <p>⑤ Track Low Voltage
1m: 71-7624-60-00
2m: 71-7625-60-00
3m: 71-7626-60-00</p> <p>⑥ L Vertical
71-A245-60-00</p> | <p>⑦ T joint
71-A246-60-00</p> <p>⑧ Converter Casambi DALI
71-8115-00-00</p> <p>⑨ L joint
71-7627-60-00</p> <p>⑩ I joint
71-7639-60-00</p> | <p>⑪ Black cap
1m: 71-8030-60-00
2m: 71-8031-60-00
3m: 71-8032-60-00</p> <p>⑫ L Vertical joint
71-A244-60-00</p> |
|--|--|--|--|



TRACK Low Voltage Pendant

Installationsschema Schema di installazione

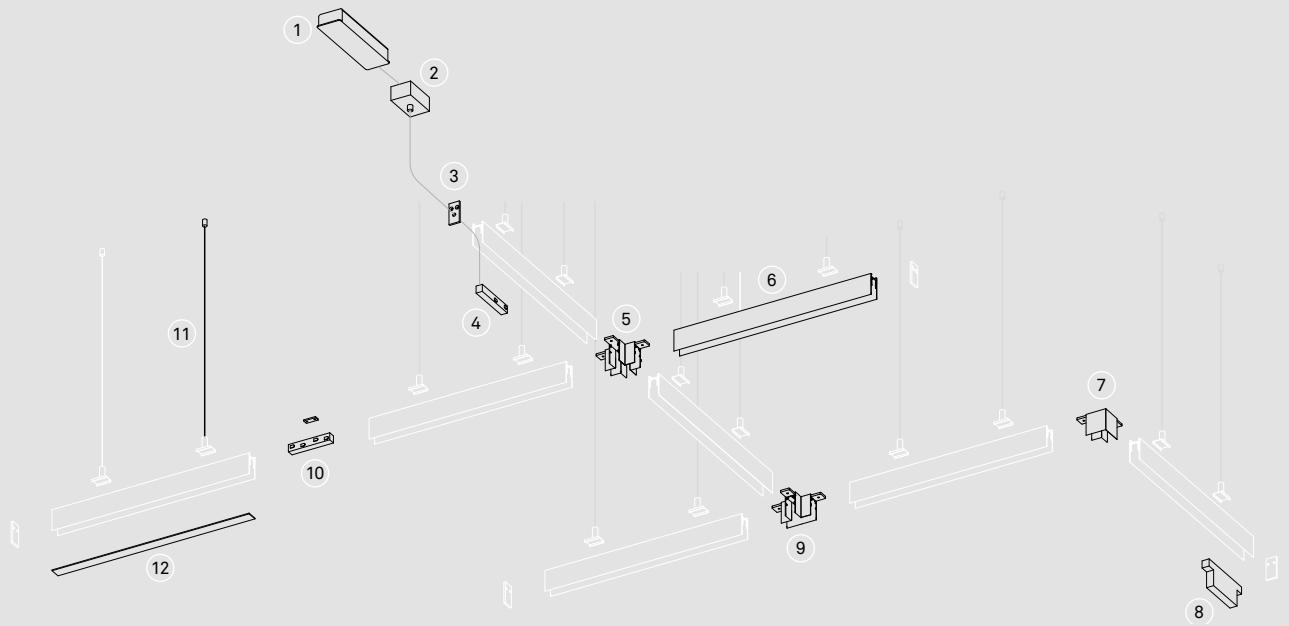

- | | | | |
|--|---|---|---|
| <p>1 Power source
71-7646-00-00
(48V / 150W)
71-7647-00-00
(48V / 240W)
71-7648-00-00
(for DIN 48V / 240W track)
71-A258-00-00
(48V / 75W)
71-A259-00-00
(48V / 120W)</p> | <p>4 Power connector
71-7637-60-00</p> <p>5 X joint
71-A247-60-00</p> <p>6 Track Low Voltage
1m: 71-7624-60-00
2m: 71-7625-60-00
3m: 71-7626-60-00</p> | <p>7 L joint
71-7627-60-00</p> <p>8 Converter Casambi DALI
71-8115-00-00</p> <p>9 T joint
71-A246-60-00</p> <p>10 I joint
71-7629-60-00</p> | <p>11 Suspension installation kit
71-7676-00-00</p> <p>12 Black cap
1m: 71-8030-60-00
2m: 71-8031-60-00
3m: 71-8032-60-00</p> |
| <p>2 Suspended ceiling
Rose power outlet
● 71-7520-60-00
○ 71-7520-14-00</p> | | | |
| <p>3 End cap
71-7705-00-00</p> | | | |

TRACK

Low Voltage Surfaced & Pendant



14 60

53.7

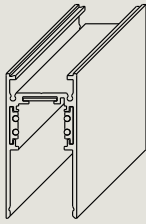

26

mm	Code
1000	71-7624
2000	71-7625 - 14 - 00
3000	71-7626 - 60 - 00

Anschlusszubehör nicht inbegriffen / Accessori di connessione non inclusi

	Installationsset Aufhängung Kit installazione sospesa	71-7676-00-00
	Netzverbinder für Low-Voltage Schiene Weiß Connettore di alimentazione per binario Low Voltage colore bianco	71-7637-14-00
	Netzverbinder für Low-Voltage Schiene Schwarz Connettore di alimentazione per binario Low Voltage colore nero	71-7637-60-00
	Hänge-Fleuron mit Stromanschluss Weiß Rosone sospeso presa di corrente bianco	71-7520-14-00
	Hänge-Fleuron mit Stromanschluss Schwarz Rosone sospeso presa di corrente nero	71-7520-60-00
	Abschlussabdeckung Weiß für LV Schiene Tappo di chiusura per binario LV bianco	71-7705-14-00
	Abschlussabdeckung Schwarz für LV Schiene Tappo di chiusura per binario LV nero	71-7705-00-00
	Abdeckung Weiß 1000 mm Tappo colore bianco 1000mm	71-8030-14-00
	Abdeckung Schwarz 1000 mm Tappo nero 1000mm	71-8030-60-00
	Abdeckung Weiß 2000 mm Tappo colore bianco 2000mm	71-8031-14-00
	Abdeckung Schwarz 2000mm Tappo nero 2000mm	71-8031-60-00
	Abdeckung Weiß 3000 mm Tappo colore bianco 3000mm	71-8032-14-00
	Abdeckung Schwarz 3000mm Tappo nero 3000mm	71-8032-60-00
	"I" Verbinder für Pendelschiene Weiß Unione ad "I" per binario da sospensione colore bianco	71-7629-14-00
	"I" Verbindung für Aufhängeschiene Schwarz Unione a "I" per binario da sospensione colore nero	71-7629-60-00

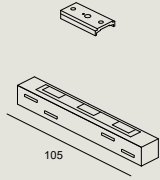
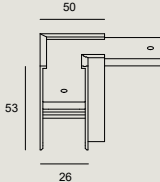
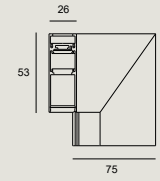
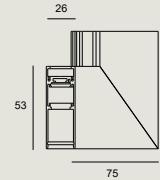
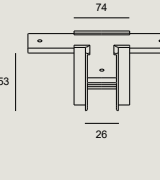
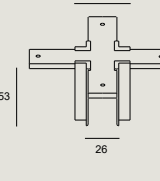
	<p>"I" Verbinder für Aufbauschiene Weiß 71-7639-14-00 Unione ad "I" per binario in superficie bianco</p>
	<p>"I" Verbinder für Aufbauschiene Schwarz 71-7639-60-00 Unione ad "I" per binario in superficie nero</p>
	<p>"L" Verbinder für Aufbau- / Pendelschiene Weiß 71-7627-14-00 Unione ad "L" per binario in superficie e/o sospenso colore bianco</p>
	<p>"L" Verbinder für Aufbau- / Pendelschiene Schwarz 71-7627-60-00 Unione ad "L" per binario in superficie e/o sospenso colore nero</p>
	<p>Innen-vertikaler "L" Verbinder für Aufbau- / Pendelschiene Weiß 71-A244-14-00 Unione verticale ad "L" per binario in superficie e/o sospenso colore bianco</p>
	<p>Innen-vertikaler "L" Verbindung für Oberfläche / Aufhängeschiene Schwarz 71-A244-60-00 Unione verticale a "L" per binario superficie / sospensione nero</p>
	<p>Aussen-vertikaler "L" Verbinder für Aufbau- / Pendelschiene Weiß 71-A245-14-00 Unione verticale ad "L" per binario in superficie e/o sospenso colore bianco</p>
	<p>Aussen-vertikaler "L" Verbindung für Oberfläche / Aufhängeschiene Schwarz 71-A245-60-00 Unione verticale a "L" per binario superficie / sospensione nero</p>
	<p>Aussen-vertikaler "T" Verbinder für Aufbau- / Pendelschiene Weiß 71-A246-14-00 Unione verticale ad "T" per binario in superficie e/o sospenso colore bianco</p>
	<p>Aussen-vertikaler "T" Verbinder für Aufbau / Aufhängeschiene Schwarz 71-A246-60-00 Unione a "T" per binario superficie / sospensione nero</p>
	<p>Aussen-vertikaler "X" Verbinder für Aufbau- / Pendelschiene Weiß 71-A247-14-00 Unione verticale ad "X" per binario in superficie e/o sospenso colore bianco</p>
	<p>Aussen-vertikaler "X" Verbinder für Aufbau- / Aufhängeschiene Schwarz 71-A247-60-00 Unione a "X" per binario superficie / sospensione nero</p>

nicht inklusive / Non incluso	
Betriebsgerät 48V / 150W Alimentatore 48V / 150W	71-7646-00-00
Betriebsgerät 48V / 240W Alimentatore 48V / 240W	71-7647-00-00
Stromquelle für DIN-Schiene mit 48 V / 240 W Fonte di alimentazione per binario DIN 48V / 240W	71-7648-00-00
Betriebsgerät 48V / 75W Alimentatore 48V / 75W	71-A258-00-00
Betriebsgerät 48V / 120W Alimentatore 48V / 120W	71-A259-00-00

Smart Compatible-Zub. / Access. Smart Compatibile
71-8115-00-00 Converter Casambi DALI Low Voltage



TRACK Low Voltage Recessed

Installationsschema Schema di installazione

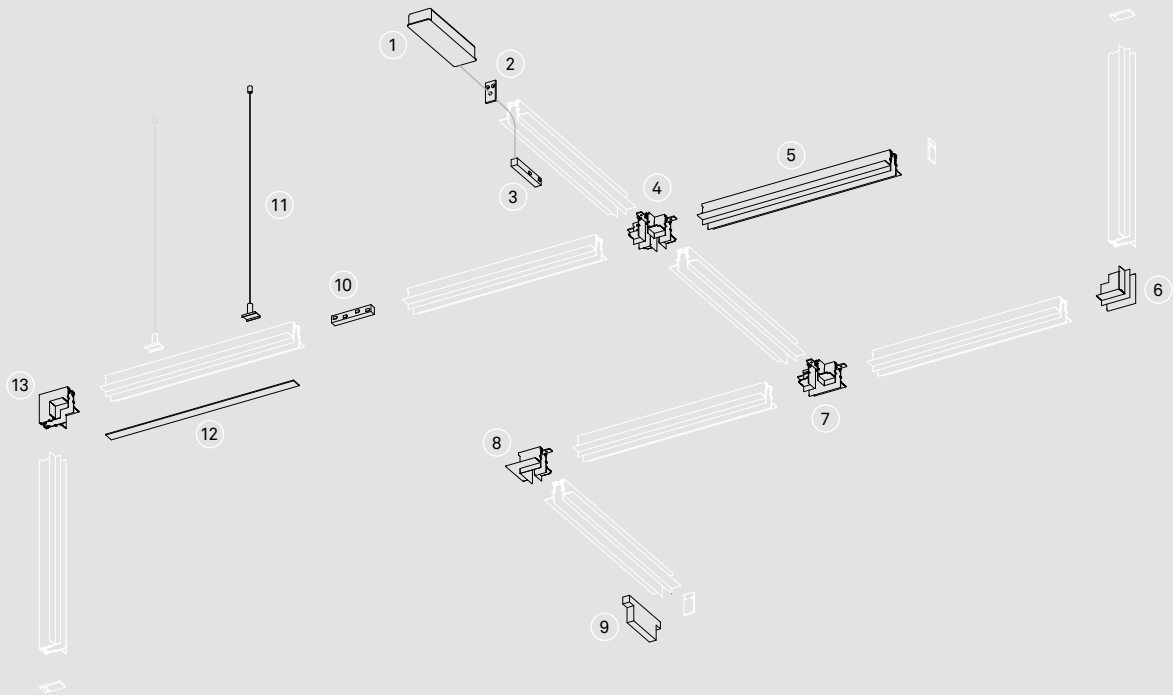

- | | | | |
|--|--|---|---|
| <p>1 Power source
71-7646-00-00
(48V / 150W)
71-7647-00-00
(48V / 240W)
71-7648-00-00
(for DIN 48V / 240W track)
71-A258-00-00
(48V / 75W)
71-A259-00-00
(48V / 120W)</p> | <p>4 X joint
71-A251-60-00</p> <p>5 Track Low Voltage
1m: 71-7630-60-00
2m: 71-7631-60-00
3m: 71-7632-60-00</p> <p>6 L Vertical joint
71-A249-60-00</p> | <p>7 T joint
71-A250-60-00</p> <p>8 Converter Casambi DALI
71-8115-00-00</p> <p>9 L joint
71-7706-60-00</p> <p>10 I joint
71-7633-60-00</p> | <p>11 Suspension installation kit
71-7676-00-00</p> <p>12 Black cap
1m: 71-8030-60-00
2m: 71-8031-60-00
3m: 71-8032-60-00</p> <p>13 L Vertical joint
71-A248-60-00</p> |
| <p>2 End cap
71-7705-00-00</p> <p>3 Power connector
71-7637-60-00</p> | | | |

TRACK

Low Voltage

Recessed

BODY MAT
ST,AL



14 60

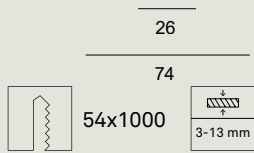
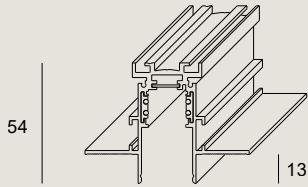

mm	Code
1000	71-7630
2000	71-7631 - 14 - 00
3000	71-7632 - 60 - 00

Anschlusszubehör nicht inbegriffen / Accessori di connessione non inclusi

	Einbausatz kit di installazione	71-7634-00-00
	Netzverbinder für Low-Voltage Schiene Weiß Connettore di alimentazione per binario Low Voltage colore bianco	71-7637-14-00
	Netzverbinder für Low-Voltage-Schiene Schwarz Connettore di alimentazione per binario Low Voltage colore nero	71-7637-60-00
	Abschlussabdeckung Weiß für LV Schiene Tappo di chiusura per binario LV bianco	71-7705-14-00
	Abschlussabdeckung Schwarz für LV Schiene Tappo di chiusura per binario LV nero	71-7705-00-00
	Abdeckung Weiß 1000 mm Tappo colore bianco 1000mm	71-8030-14-00
	Abdeckung Schwarz 1000 mm Tappo nero 1000mm	71-8030-60-00
	Abdeckung Weiß 2000 mm Tappo colore bianco 2000mm	71-8031-14-00
	Abdeckung Schwarz 2000mm Tappo nero 2000mm	71-8031-60-00
	Abdeckung Weiß 3000 mm Tappo colore bianco 3000mm	71-8032-14-00
	Abdeckung Schwarz 3000mm Tappo nero 3000mm	71-8032-60-00
	I-Verbinder für Einbau- und Up&Down Schiene Weiß Unione ad I per binario incasso e/o Up&Down colore bianco	71-7633-14-00
	"I" -Verbindung für versenkte / Up&Down Schiene Schwarz Unione a "I" per binario incasso / Up&Down colore nero	71-7633-60-00
	"L" -Verbindung für versenkte Schiene Weiß Unione ad L per binario incassato colore bianco	71-7706-14-00
	"L" -Verbindung für versenkte Schiene Schwarz Unione a "L" per binario incasso colore nero	71-7706-60-00

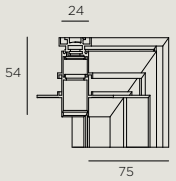
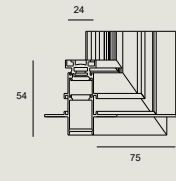
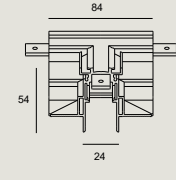
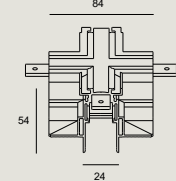
	Innen-vertikaler L-Verbinder für Einbauschiene Weiß Unione verticale ad L per binario ad incasso colore bianco	71-A248-14-00
	Vertikale "L" -Verbindung für versenkte Schiene Schwarz Unione verticale a "L" per binario incasso colore nero	71-A248-60-00
	Innen-vertikaler "L" Verbinder für Einbauschiene Weiß Unione verticale ad "L" per binario ad incasso colore bianco	71-A249-14-00
	Vertikale "L" Verbindung für versenkte Schiene Schwarz Unione verticale a "L" per binario incasso colore nero	71-A249-60-00
	"T" Verbinder für Einbauschiene Weiß Unione a "T" per binario ad incasso colore bianco	71-A250-14-00
	"T" Verbindung für versenkte Schiene Schwarz Unione a "T" per binario incasso colore nero	71-A250-60-00
	"X" Verbinder für Einbauschiene Weiß Unione ad "X" per binario ad incasso colore bianco	71-A251-14-00
	"X" Verbindung für versenkte Schiene Schwarz Unione a "X" per binario incasso colore nero	71-A251-60-00

nicht inklusive / Non incluso	
Betriebsgerät 48V / 150W Alimentatore 48V / 150W	71-7646-00-00
Betriebsgerät 48V / 240W Alimentatore 48V / 240W	71-7647-00-00
Stromquelle für DIN-Schiene mit 48 V / 240 W Fonte di alimentazione per binario DIN 48V / 240W	71-7648-00-00
Betriebsgerät 48V / 75W Alimentatore 48V / 75W	71-A258-00-00
Betriebsgerät 48V / 120W Alimentatore 48V / 120W	71-A259-00-00

Smart Compatible-Zub. / Access. Smart Compatibile	
71-8115-00-00 Converter Casambi DALI Low Voltage	



TRACK Low Voltage Up&Down

Installationsschema Schema di installazione

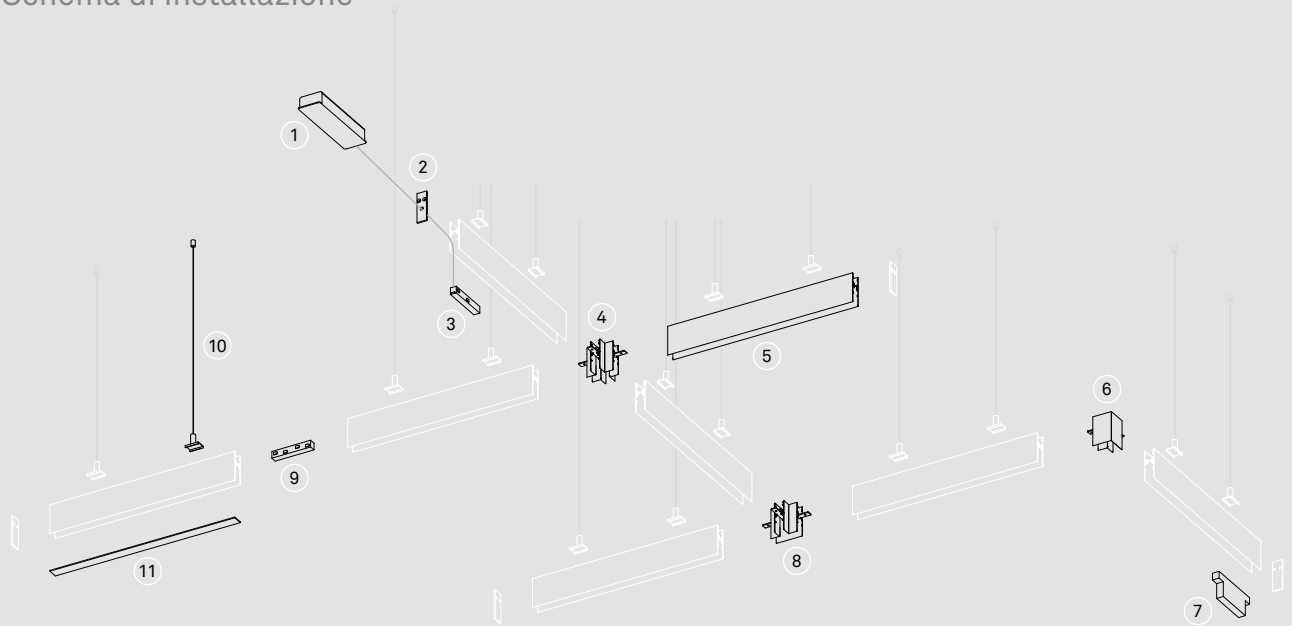

- | | | | |
|--|---|---|--|
| <p>1 Power source
71-7646-00-00
(48V / 150W)
71-7647-00-00
(48V / 240W)
71-7648-00-00
(for DIN 48V / 240W track)
71-A258-00-00
(48V / 75W)
71-A259-00-00
(48V / 120W)</p> | <p>4 X joint
71-A253-60-00
71-A253-14-00</p> | <p>7 Converter Casambi DALI
71-8115-00-00</p> | <p>10 Suspension installation kit
71-8124-00-00</p> |
| <p>2 Track end cap
71-8046-60-00
71-8045-14-00</p> | <p>5 Track Low Voltage
1m: 71-8043-60-00
1m: 71-8043-14-00
2m: 71-8044-60-00
2m: 71-8044-14-00
3m: 71-8045-60-00
3m: 71-8045-14-00</p> | <p>8 T joint
71-A252-60-00
71-A252-14-00</p> | <p>11 Black cap
1m: 71-8030-60-00
1m: 71-8030-14-00
2m: 71-8031-60-00
2m: 71-8031-14-00
3m: 71-8032-60-00
3m: 71-8032-14-00</p> |
| <p>3 Power connector
71-7637-60-00
71-7637-14-00</p> | <p>6 L joint
71-8047-60-00
71-8047-14-00</p> | <p>9 I joint
71-7633-60-00
71-7633-14-00</p> | |

TRACK

Low Voltage

Up&Down

BODY MAT
AL



14 60

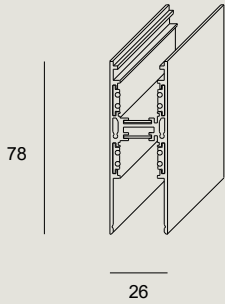

mm	Code
1000	71-8043
2000	71-8044 - 14 - 00
3000	71-8045 - 60 - 00

Anschlusszubehör nicht inbegriffen / Accessori di connessione non inclusi

	Aufhängeset Kit per installazione sospesa	71-8124-00-00
	Netzverbinder für Low-Voltage Schiene Weiß Connettore di alimentazione per binario Low Voltage colore bianco	71-7637-14-00
	Netzverbinder für Low-Voltage-Schiene Schwarz Connettore di alimentazione per binario Low Voltage colore nero	71-7637-60-00
	Hänge-Fleuron mit Stromanschluss Weiß Rosone sospeso presa di corrente bianco	71-7520-14-00
	Hänge-Fleuron mit Stromanschluss Schwarz Rosone sospeso presa di corrente nero	71-7520-60-00
	Hänge-Fleuron mit Stromanschluss DALI Weiß Rosone sospeso presa di corrente DALI bianco	71-7521-14-00
	Hänge-Fleuron mit Stromanschluss DALI Schwarz Rosone sospeso presa di corrente DALI nero	71-7521-60-00
	Endkappe für Schiene Weiß Tappo finale per binario colore bianco	71-8046-14-00
	Endkappe für Schiene Schwarz Tappo finale per binario colore nero	71-8046-60-00
	Abdeckung Weiß 1000 mm Tappo colore bianco 1000mm	71-8030-14-00
	Kappe Schwarz 1000 mm Tappo nero 1000mm	71-8030-60-00
	Abdeckung Weiß 2000 mm Tappo colore bianco 2000mm	71-8031-14-00
	Abdeckung Schwarz 2000mm Tappo nero 2000mm	71-8031-60-00
	Abdeckung Weiß 3000 mm Tappo colore bianco 3000mm	71-8032-14-00
	Abdeckung Schwarz 3000mm Tappo nero 3000mm	71-8032-60-00

	<p>“I” Verbinder für Einbau- und Up&Down Schiene Weiß 71-7633-14-00 Unione ad “I” per binario incasso e/o Up&Down colore bianco</p> <p>“I” Verbinder für Einbau- und Up&Down Schiene Schwarz 71-7633-60-00 Unione ad “I” per binario incasso e/o Up&Down colore nero</p>
	<p>“L” Verbindung für Up&Down Schiene Weiß 71-8047-14-00 Unione ad “L” per binario Up&Down colore bianco</p> <p>“L” Verbindung für Schiene Up&Down Schwarz 71-8047-60-00 Unione a “L” per binario Up&Down nero</p>
	<p>“T” Verbindung für Up&Down Schiene Weiß 71-A252-14-00 Unione ad “T” per binario Up&Down colore bianco</p> <p>“T” Verbindung für Schiene Up&Down Schwarz 71-A252-60-00 Unione a “T” per binario Up&Down nero</p>
	<p>“X” Verbindung für Up&Down Schiene Weiß 71-A253-14-00 Unione ad “X” per binario Up&Down colore bianco</p> <p>“X” Verbindung für Schiene Up&Down Schwarz 71-A253-60-00 Unione a “X” per binario Up&Down nero</p>

nicht inklusive / Non incluso	
Betriebsgerät 48V / 150W Alimentatore 48V / 150W	71-7646-00-00
Betriebsgerät 48V / 240W Alimentatore 48V / 240W	71-7647-00-00
Stromquelle für DIN-Schiene mit 48 V / 240 W Fonte di alimentazione per binario DIN 48V / 240W	71-7648-00-00
Betriebsgerät 48V / 75W Alimentatore 48V / 75W	71-A258-00-00
Betriebsgerät 48V / 120W Alimentatore 48V / 120W	71-A259-00-00

Smart Compatible-Zub. / Access. Smart Compatibile	
71-8115-00-00 Converter Casambi DALI Low Voltage	



Downlights

Downlights

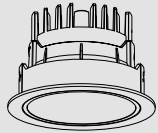

Sia
159

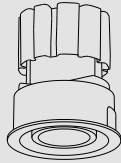

Biwa
176

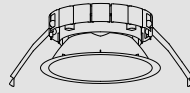

Veo
181

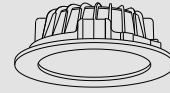

Vo1
187

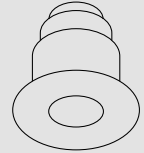

Play
191

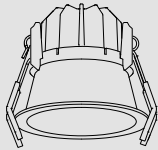

Lite
231

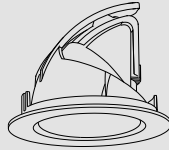

Out
234

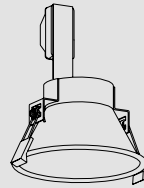

Dome
236

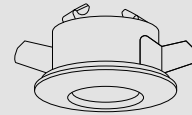

Split
239

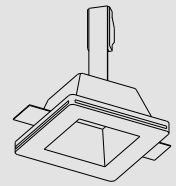

Ges
240

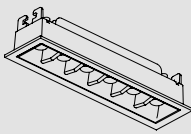

Bento
245

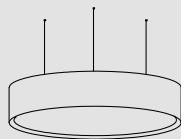

Luno
269

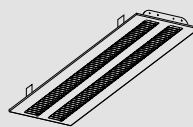

Finelight
281

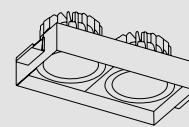

Multidir Evo
287



Sia

Sia Standard

P. 164



Ø 115 mm



Ø 170 mm



Ø 225 mm

Sia Adjustable

P. 166



Ø 115 mm



Ø 180 mm

Sia Lens

P. 167



Ø 115 mm

Trim / Trimless

12-33,4 W



Ultra Wide Flood 80°

14 ○ 60 ●



Trim / Trimless

12-33,4 W



Extra Spot 18° - Extra Medium 38°

14 ○ 60 ●



Trim / Trimless

12-17,7 W

Wall washer / Batwing
Square / Narrow

14 ○ 60 ●



SIA

BODY MAT	50000h
AL	L80 B20



Sia erzeugt ein Licht, das sich ohne Einschränkungen an Formen, Volumen und Distanzen anpasst. Durch die für Gleichmäßigkeit sorgende Polycarbonatlinse in Verbindung mit dem Hochvakuum-Chromreflektor, bietet diese Leuchte gleichmäßiges Licht und maximalen Sehkomfort bei hoher Leistung. Sia proietta una luce che si adatta a geometrie, volumi e distanze, una luce senza ostacoli. Grazie alla combinazione di una lente in policarbonato e di un riflettore cromato sotto alto vuoto, questo apparecchio offre una luce uniforme ed il massimo comfort visivo, con alte prestazioni.

Umfangreiche Familie Ampiezza famiglia

Die Kollektion beinhaltet drei Familien: Sia Standard, Sia Adjustable und Sia Lens. Diese passen sich mit höchster Präzision dem Projekt an, wie dem gemeinsamen UGR-Wert von unter 19 und einer Gesamtgleichmäßigkeit in der Farbsortierung von 2 MacAdam.

Le tre famiglie della collezione (Sia Standard, Sia Adjustable e Sia Lens) si adattano alle esigenze di ogni progetto con caratteristiche molto precise che hanno in comune un UGR >19 ed un'uniformità totale di 2 Macadam.



Höchster Komfort und Leistung Massimo comfort e prestazioni

Perfekte Ausgewogenheit zwischen Sehkomfort mit einem Cut-off-Winkel von 30°, einem UGR-Wert von <19 und einer Leistung von 117 lm/w. Das optische System ist auf maximalen Komfort und Lichtgleichmäßigkeit ausgelegt.

Perfetto equilibrio tra comfort visivo, con un angolo di cut-off di 30°, un valore UGR <19 ed un rendimento di 117 lm/W. Il sistema ottico è progettato per ottenere il massimo comfort ed uniformità della luce.

- ① Wärmeableiter
Dissipatore termico
- ② Hoher Komfort-Reflektor
Riflettore ad alto comfort
- ③ Zubehör Honeycomb
Accessorio Honeycomb
- ④ Sekundärreflektor
Riflettore secondario
- ⑤ Cut-off-Winkel von 30°
Angolo cut-off 30°

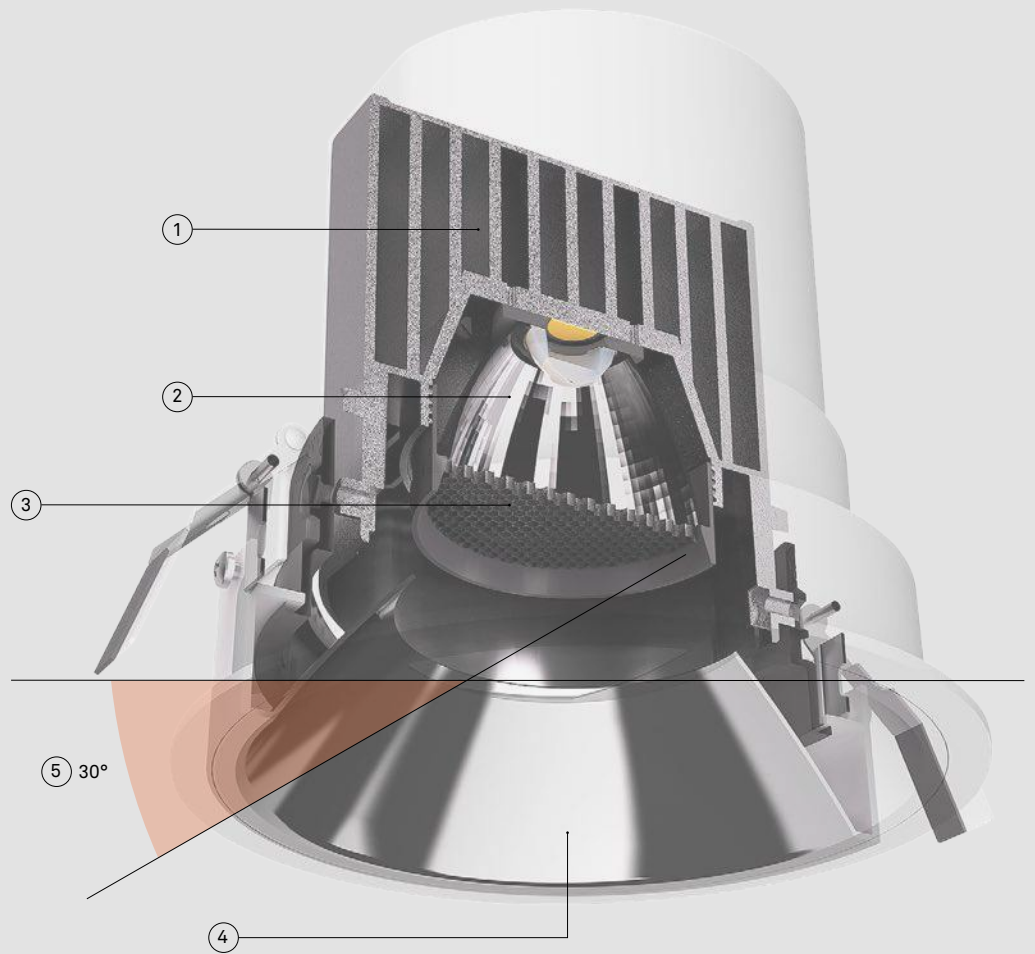

Notlicht-Versionen Versioni di emergenza

Sia bietet Notlichtversionen für Bereiche an, in denen Anti-Panikbeleuchtung erforderlich ist. Diese werden mit einer LED zur Anzeige des Batteriestands geliefert, die extern an der optischen Einheit installiert werden muss.

Sia offre versioni di emergenza per quelle zone che richiedono un'illuminazione antipanico. Il modello è fornito con un LED di segnalazione dello stato della batteria, che deve essere installato a distanza dal gruppo ottico.



Tunable White

Sia ist in Tunable White-Versionen erhältlich, bei denen die Farbtemperatur entweder manuell über ein Konnektivitätssystem oder durch automatische Anpassung der Farbtemperatur anhand eines Zeitprogramms eingestellt werden kann.

Sia dispone di versioni Tunable White che permettono una regolazione della temperatura di colore, sia manualmente, attraverso un sistema di connettività, o automaticamente, mediante una programmazione oraria.



Smart-Funktionen:
Energieeinsparung
Funzionalità Smart:
Risparmio energetico

Sia ermöglicht den Kauf des Treibers, der den Anforderungen der jeweiligen Anlage am besten entspricht. Einerseits gibt es die Option eines Treibers mit integrierter Casambi Bluetooth Mesh-Technologie für Anlagen, bei denen die Interaktion mit Licht im Mittelpunkt steht. Zum anderen kann ein D4i-Treiber gewählt werden, der sich besonders für Anlagen eignet, bei denen Energieeinsparungen und Beleuchtungskontrolle wichtig sind. Einige Sia-Produkte sind Teil des Zertifizierungsprogramms für Leuchten "YellowDot", das unsere Leuchten für die Verwendung der Positionierungstechnologie für Innenräume zertifiziert.

Sia offre la possibilità di acquistare il driver che meglio si adatta alle esigenze dell'installazione. Da un lato dispone dell'opzione driver con tecnologia Casambi Bluetooth Mesh integrata, per quelle installazioni dove è importante l'interazione con la luce. Inoltre, è possibile optare per un driver D4i, particolarmente indicato per quegli impianti dove l'obiettivo è il risparmio energetico ed il controllo dell'occupazione. Alcuni prodotti Sia sono inclusi nel Programma di Certificazione di apparecchi di illuminazione Yellowdot che certifica i nostri prodotti per l'utilizzo della tecnologia di posizionamento interno.



SIA STANDARD

Die Standardversion einer vielseitigen Kollektion, die sich für alle Bedürfnisse und alle Arten von Projekten eignet.

Versione standard di una collezione versatile che si adatta ad ogni esigenza e ad ogni tipo di progetto.



Verschiedene Größen Diverse misure

Erhältlich in drei Größen: Small ($\varnothing 115$), Big ($\varnothing 170$) und XL ($\varnothing 225$) mit Rahmen in Weiß, Schwarz oder ohne Rahmen.

Disponibile in tre misure, Small ($\varnothing 115$), Big ($\varnothing 170$) e XL ($\varnothing 225$) e con la possibilità di scegliere l'opzione di finitura della cornice in bianco, nero o senza cornice.



Gesamtgleichmäßigkeit Uniformità totale

Mit einem UGR-Wert von <19 und einer Gesamtgleichmäßigkeit von 2 MacAdam.

Dotato di un UGR <19 , presenta un'uniformità totale di 2 MacAdam.





SIA ADJUSTABLE

Sia Adjustable ist ein im Schwenkbereich einstellbares Downlight mit vielseitigen Einsatzmöglichkeiten. In Versionen mit verschiedenen Lichtaustrittswinkeln: narrow, spot oder medium.

Sia Adjustable è un downlight orientabile con una grande versatilità d'uso. Presenta versioni con diverse aperture del fascio di luce: narrow, spot o medium.



Zubehör zur Anpassung des Lichtstrahls

Accessori per modulare il fascio

Die Kollektion bietet eine ganze Reihe von Linsen und Zubehörteilen, mit denen sich der Lichtaustritt lenken und modulieren lässt. Honeycomb: Steigert den Sehkomfort und betont den Austrittswinkel. Elliptischer Diffusor: Verändert den Lichtaustritt und verlängert ihn. Ideal für Flure. Quadratischer Diffusor: Verändert den Lichtaustritt und formt ihn quadratisch, so dass die Beleuchtung besser an die jeweilige Raumsituation angepasst werden kann. Weichzeichnerlinse: Macht den Lichtaustritt weniger definiert und erzeugt einen Unschärfeeffekt. La collezione comprende una varietà di lenti ed accessori che permettono di controllare e modulare il fascio di luce. Honeycomb: aumenta il comfort e risalta l'angolo di uscita. Diffusore ellittico: modifica il fascio di luce per allungarlo. È ideale per corridoi. Diffusore quadrato: modifica il fascio di luce e lo rende quadrato, consentendo una miglior adattabilità dell'illuminazione agli spazi. Diffusore ad alone: fa sì che l'uscita della luce non abbia un angolo così marcato e crea un effetto sfumato.



Honeycomb
Honeycomb



Elliptischer Diffusor
Diffusore ellittico



Quadratischer Diffusor
Diffusore quadrato



Weichzeichnerlinse
Diffusore ad alone

SIA LENS

Sia Lens nutzt ein Linsensystem, das zur Erzeugung verschiedener Lichteffekte dient.

Sia Lens incorpora un sistema di lenti che permette di creare diversi effetti di luce.



Lichteffekte Effetti di luce

Wall Washer: Die Wandfluterlinse erzeugt einen perfekten Effekt an jeder Wand und sorgt für eine homogene Ausleuchtung vertikaler Flächen.

Batwing: Zweiseitige Ausstrahlung zur Beleuchtung von Flurwänden, für einen gleichmäßigen Effekt von der Decke bis zum Boden. Um Wände zu akzentuieren und hervorzuheben sowie ein Gefühl von Geräumigkeit zu erzielen.

Square: Formt den Lichtstrahl quadratisch, sodass die Beleuchtung besser an die jeweiligen Räume angepasst werden kann.

Narrow: Mit 26°-Winkel mittlerer Öffnung, einem kontrolliertem und klarem Lichtkegel ohne Restlicht, der Akzenteffekte erzielt.

Wall washer: produce un effetto bagno perfetto, su qualsiasi parete.

Batwing: emissione bilaterale per illuminare pareti di corridoi, creando un effetto uniforme dal soffitto al pavimento accentuando ed evidenziando pareti ed ottenendo una sensazione di ampiezza.

Square: proietta un fascio di luce quadrato, che permette una miglior adattabilità dell'illuminazione agli spazi.

Narrow: dispone di un fascio di 26° di apertura media, di luce controllata, nitida e senza residui, per ottenere effetti di accento.

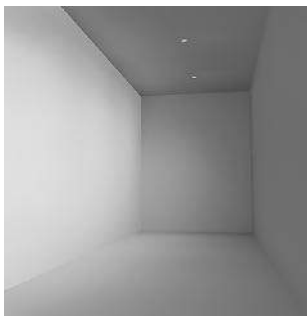

Wall washer



Batwing

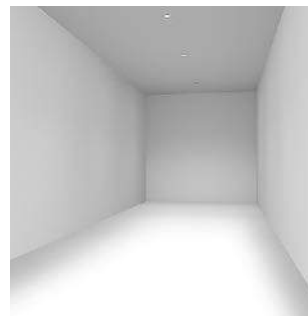

Square

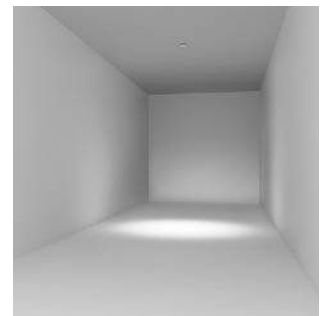







Narrow

SIA

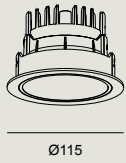
Standard 115

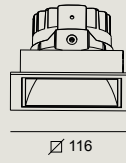
DIF MAT	IP	2		WELL	(SC)
PC	54	MacAdam			

Codebeispiel / Esempio di codice: AH11-12V8W10U14

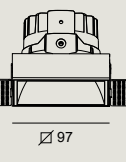
Model	W	K/ CRI/ Real lm	Optics	Source	Finishes
AH11 - Rund / Klein / Mit Rahmen Rotondo / Piccolo / Con Cornice Ø 115  	12 12W	V8 2700K CRI80/1407 lm	W1 77°	OU ON-OFF 100-240V/50-60Hz	AH11 / AH13 14 60 AH12 / AH14 WT
		W8 3000K CRI80/1407 lm		DS DALI-2 100-240V/50-60Hz	
		W9 3000K CRI90/1261 lm		O3 Emergency ON-OFF 3H 220-240V 50-60Hz	
		X8 4000K CRI80/1401 lm		D3 Emergency W DALI-2 3H 220-240V 50-60Hz	
AH13 - Quadratisch / Klein / Mit Rahmen Quadrato / Piccolo / Con Cornice 100x100  	17 17.7W	V8 2700K CRI80/1829 lm	W1 77°	OU ON-OFF 100-240V/50-60Hz	(SC)
		W8 3000K CRI80/1829 lm		DS DALI-2 100-240V/50-60Hz	
		W9 3000K CRI90/1640 lm		O3 Emergency ON-OFF 3H 220-240V 50-60Hz	
AH12 - Rund / Klein / Ohne Rahmen Rotondo / Piccolo / Senza Cornice Ø 96  		X8 4000K CRI80/1822 lm	D3 Emergency DALI-2 3H 220-240V 50-60Hz	BB 36V/Max. 500mA (SC)	
		AH14 - Quadratisch / Klein / Ohne Rahmen Quadrato / Piccolo / Senza Cornice 97x97  			

Smart Compatible-Zub. / Access. Smart Compatibile
71-A260-00-00 Driver Casambi 350-1050mA 38W (BB)

SIA

Sia Standard 115
TW

DIF MAT		IP	3	UGR	LOW			DALI DT8	WELL	(SC)
PC		54	MacAdam	<22	FLICKER					

Codebeispiel / Esempio di codice: AH11-13U9W1TW14

Model	W	K/ CRI/ Real lm	Optics	Source	Finishes
AH11 - Rund / Klein / Mit Rahmen Rotondo / Piccolo / Con Cornice Ø 115  	13 12.6W	U9 TW 2700K-6500K/ CRI92/1124 lm	W1 80°	TW DALI DT8 220-240V/50-60Hz	14 60

Smart Compatible-Zub. / Access. Smart Compatibile
71-5961-00-00 Dimmer DALI Casambi

SIA

Standard 170

DIF MAT
PC

IP
54

2
MacAdam



WELL



Codebeispiel / Esempio di codice: AH15-25V8W10U14

Model	W	K/ CRI/ Real lm	Optics	Source	Finishes
AH15 - Rund / Groß / Mit Rahmen Rotondo / Grande / Con Cornice 150	25 25W	V8 2700K CRI80/2840 lm	W1 79°	OU ON-OFF 100-240V/50-60Hz	AH15 / AH17 14
		W8 3000K CRI80/2840 lm		DS DALI 220-240V/50-60Hz	
		W9 3000K CRI90/2572 lm		O3 Emergency ON-OFF 3H/220-240V/50-60Hz	AH16 / AH18 WT
		X8 4000K CRI80/2858 lm		D3 Emergency DALI 3H 220-240V/50-60Hz	
AH17 - Quadratisch / Groß / Mit Rahmen Quadrato / Grande / Con Cornice 150x150	33 33.4W	V8 2700K CRI80/3459 lm	W1 79°	OU ON-OFF 100-240V/50-60Hz	14
		W8 3000K CRI80/3459 lm		DS DALI 220-240V/50-60Hz	
		W9 3000K CRI90/3133 lm		O3 Emergency ON-OFF 3H/220-240V/50-60Hz	WT
		X8 4000K CRI80/3481 lm		D3 Emergency DALI 3H/220-240V/50-60Hz	
AH16 - Rund / Groß / Ohne Rahmen Rotondo / Grande / Senza Cornice 141	123		Ø141	D3	BB
AH18 - Quadratisch / Groß / Ohne Rahmen Quadrato / Grande / Senza Cornice 144x144	123		Ø 144	D3	BB

Smart Compatible-Zub. / Access. Smart Compatibile 71-7737-00-00 Driver D4i 700mA 27W 71-A260-00-00 Driver Casambi 350-1050mA 38W (BB)
--

SIA

Standard 225

DIF MAT
PC

IP
54









2
MacAdam

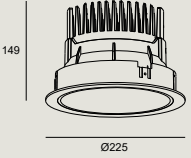

WELL

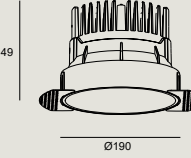

Codebeispiel / Esempio di codice: AH19-37W8W1OU14

Model	W	K/ CRI/ Real lm	Optics	Source	Finishes		
AH19 - Rund / extragroß / Mit Rahmen Rotondo / XL / Con Cornice 215  	37 37W	W8 3000K CRI80/3548 lm	W1 76°	OU ON-OFF 100-240V/50-60Hz	AH19 14  60  AH21 WT 		
		W9 3000K CRI90/3080 lm		DS DALI 220-240V/50-60Hz			
		X8 4000K CRI80/3548 lm		O3 Emergency ON-OFF 3H/220- 240V/50-60Hz			
		D3 Emergency DALI 3H 220-240V/50- 60Hz	BB 36V/Max. 1000mA 				
	AH21 - Rund / extragroß / Ohne Rahmen Rotondo / XL / Senza Cornice 190  	44 44.5W		W8 3000K CRI80/4102 lm		W1 76°	OU ON-OFF 100-240V/50-60Hz
				W9 3000K CRI90/3560 lm			DS DALI 100-277V/50- 60Hz
X8 4000K CRI80/4102 lm			O3 Emergency ON-OFF 3H/220-240V/50- 60Hz				
	D3 Emergency DALI 3H/220-240V/50- 60Hz	BB 36V/Max. 1200mA 					

Smart Compatible-Zub. / Access. Smart Compatibile

71-A261-00-00 Driver Casambi HC 650-1400mA 45W

SIA

Standard 225 Low UGR

DIF MAT		IP	2	UGR		WELL	
PC		54	MacAdam	<19			

Codebeispiel / Esempio di codice: AH19-18X8W1WR14

Model	W	K/ CRI/ Real lm	Optics	Source	Finishes
AH19 - Rund / extragroß / Mit Rahmen Rotondo / XL / Con Cornice Ⓟ 215	18 18W	X8 4000K CRI80/2057 lm	W1 76°	WR DALI D4i 220-240V/50-60Hz	14
				O3 Emergency ON-OFF 3H/220-240V/50-60Hz	
				D3 Emergency DALI-2 3H/220-240V/50-60Hz	

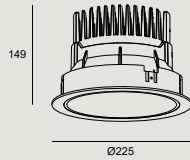

Smart Compatible-Zub. / Access. Smart Compatibile

71-5961-00-00 Dimmer DALI Casambi

SIA

Standard 225 Tunable White

DIF MAT		IP	3	UGR	LOW				WELL
PC		54	MacAdam	<19	FLICKER				

Codebeispiel / Esempio di codice: AH19-25U9W1TW14

Model	W	K/ CRI/ Real lm	Optics	Source	Finishes
AH19 - Rund / extragroß / Mit Rahmen Rotondo / XL / Con Cornice Ⓟ 215	25 25.2W	U9 TW 2700K-6500K CRI92/2337 lm	W1 80°	TW DALI DT8 220-240V/50-60Hz	14

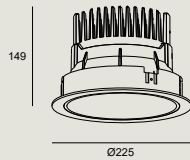

Smart Compatible-Zub. / Access. Smart Compatibile

71-5961-00-00 Dimmer DALI Casambi

SIA

Adjustable 115

DIF MAT
PC

IP
23







2
MacAdam

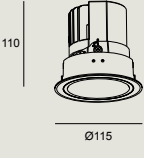

WELL

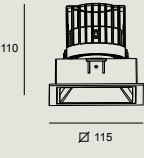

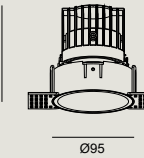
Codebeispiel / Esempio di codice: AH31-12V8S3OU14

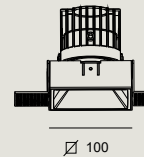
Model	W	K/ CRI/ Real lm	Optics	Source	Finishes
AH31 - Rund / Klein / Mit Rahmen Rotondo / Piccolo / Con Cornice Ø 105  	12 12W	V8 2700K CRI80/1075 lm	S3 20° M3 37°	OU ON-OFF 100-240V/50-60Hz	AH31 / AH33 14 60 AH32 / AH34 WT
		W8 3000K CRI80/988 lm		DS DALI-2 100-240V/50-60Hz	
		W9 3000K CRI90/979 lm		BB 36V/Max. 350mA 	
		X8 4000K CRI80/1128 lm			
AH33 - Quadratisch / Klein / Mit Rahmen Quadrato / Piccolo / Con Cornice 102x102  	17 18W	V8 2700K CRI80/1463 lm	S3 20° M3 37°	OU ON-OFF 100-240V/50-60Hz	WT
		W8 3000K CRI80/1347 lm		DS DALI-2 100-240V/50-60Hz	
		W9 3000K CRI90/1335 lm		BB 36V/Max. 500mA 	
		X8 4000K CRI80/1538 lm			
AH32 - Rund / Klein / Ohne Rahmen Rotondo / Piccolo / Senza Cornice Ø 95  					
AH34 - Quadratisch / Klein / Ohne Rahmen Quadrato / Piccolo / Senza Cornice 100x100  					

nicht inklusive / Non incluso

Wabenraster (1 VPE=5 Stk.) Pannello a nido d'ape (5 unità)	71-5166-60-00
Elliptischer Diffusor (1 VPE=5 Stk.) Diffusore ellittico (5 unità)	71-5167-00-00
Weichzeichnerlinse (1 VPE=5 Stk.) Sagomatore di fascio (5 unità)	71-6099-00-00

Smart Compatible-Zub. / Access. Smart Compatibile







71-A260-00-00 Driver Casambi 350-1050mA 38W (BB)

SIA

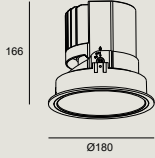
Adjustable 170

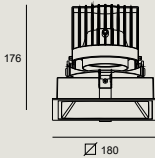
DIF MAT	IP	2		WELL	(SC)
PC	23	MacAdam			

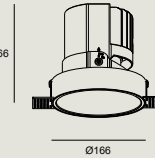
Codebeispiel / Esempio di codice: AH35-25V8S3OU14

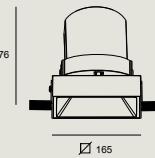
Model	W	K/ CRI/ Real lm	Optics	Source	Finishes
AH35 - Rund / Groß / Mit Rahmen Rotondo / Grande / Con Cornice Ø 170  	25 25W	V8 2700K CRI80/1984 lm	S3 19°	OU ON-OFF 100-240V/50-60Hz	AH35 / AH37 14
		W8 3000K CRI80/1810 lm	M2 28°	DS DALI 220-240V/50-60Hz	
		W9 3000K CRI90/1621 lm	M3 38°	BB 36V/Max. 700mA (SC)	AH36 / AH38 60
		X8 4000K CRI80/1868 lm			
AH37 - Quadratisch / Groß / Mit Rahmen Quadrato / Grande / Con Cornice 167x167  	33 33.8W	V8 2700K CRI80/2401 lm	S3 19°	OU ON-OFF 100-240V/50-60Hz	WT
		W8 3000K CRI80/2188 lm	M2 28°	DS DALI 220-240V/50-60Hz	
		W9 3000K CRI90/1912 lm	M3 38°	BB 36V/Max. 900mA (SC)	
		X8 4000K CRI80/2203 lm			
AH36 - Rund / Groß / Ohne Rahmen Rotondo / Grande / Senza Cornice Ø 166  					
AH38 - Quadratisch / Groß / Ohne Rahmen Quadrato / Grande / Senza Cornice 165x165  					

nicht inklusive / Non incluso	
Zubehör Wabenplatte Accessorio pannello d ape	71-5201-60-00
Zubehör elliptischer Diffusor Accessorio diffusore ellittico	71-5646-60-00
Zubehör quadratischer Diffusor Accessorio diffusore quadrato	71-5647-60-00



Smart Compatible-Zub. / Access. Smart Compatibile	
71-7737-00-00 Driver D4i 700mA 27W	
71-A260-00-00 Driver Casambi 350-1050mA 38W (BB)	

SIA

Lens Wallwasher

DIF MAT	IP	2	WELL	(SC)
PMMA	54	MacAdam		

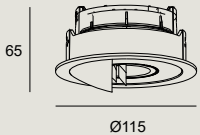
Codebeispiel / Esempio di codice: AH22-12V8AZOUWR

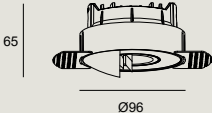
Model	W	K/ CRI/ Real lm	Optics	Source	Finishes
AH22 - Wall Washer / Mit Rahmen Wall Washer / Con Cornice Ⓢ 100  	12 12W	V8 2700K CRI80/1297 lm	AZ Wallwasher	OU ON-OFF 100-240V/50-60Hz	AH22
		W8 3000K CRI80/1297 lm		DS DALI-2 100-240V/50-60Hz	WR
		W9 3000K CRI90/1297 lm		BB 36V/Max. 350mA (SC)	WN
		X8 4000K CRI80/1297 lm			AH23
AH23 - Wall washer / Ohne Rahmen Wall Washer / Senza Cornice Ⓢ 96  	17 17.7W	V8 2700K CRI80/1659 lm	AZ Wallwasher	OU ON-OFF 100-240V/50-60Hz	WP
		W8 3000K CRI80/1659 lm		DS DALI-2 100-240V/50-60Hz	WQ
		W9 3000K CRI90/1659 lm		BB 36V/Max. 500mA (SC)	
		X8 4000K CRI80/1659 lm			

Smart Compatible-Zub. / Access. Smart Compatibile



71-A260-00-00 Driver Casambi 350-1050mA 38W (BB)

SIA

Lens Batwing

DIF MAT	IP	2	WELL	(SC)
PMMA	54	MacAdam		

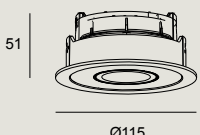
Codebeispiel / Esempio di codice: AH24-12V8AZOUWR

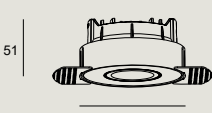
Model	W	K/ CRI/ Real lm	Optics	Source	Finishes
AH24 - Batwing / Mit Rahmen Batwing / Con Cornice Ⓢ 100  	12 12W	V8 2700K CRI80/1444 lm	AZ Batwing	OU ON-OFF 100-240V/50-60Hz	AH24
		W8 3000K CRI80/1444 lm		DS DALI-2 100-240V/50-60Hz	WR
		W9 3000K CRI90/1244 lm		BB 36V/Max. 350mA (SC)	WN
		X8 4000K CRI 80/1444 lm			AH25
AH25 - Batwing / Ohne Rahmen Batwing / Senza Cornice Ⓢ 96  	17 17.7W	V8 2700K CRI80/1886 lm	AZ Batwing	OU ON-OFF 100-240V/50-60Hz	WP
		W8 3000K CRI80/1886 lm		DS DALI-2 100-240V/50-60Hz	WQ
		W9 3000K CRI90/1624 lm		BB 36V/Max. 500mA (SC)	
		X8 4000K CRI80/1886 lm			

Smart Compatible-Zub. / Access. Smart Compatibile

71-A260-00-00 Driver Casambi 350-1050mA 38W (BB)

SIA

Lens Square

DIF MAT	IP	2		WELL	(SC)
PMMA	54	MacAdam			

Codebeispiel / Esempio di codice: AH26-12V8AZOUWR

Model	W	K/ CRI/ Real lm	Optics	Source	Finishes
AH26 - Square / Mit Rahmen Square / Con cornice 100	12 12W	V8 2700K CRI80/1392 lm	AZ Square	OU ON-OFF 100-240V/50-60Hz	AH26
		W8 3000K CRI80/1392 lm		DS DALI-2 100-240V/50-60Hz	WR
		W9 3000K CRI90/1198 lm		BB 36V/Max. 350mA (SC)	WN
		X8 4000K CRI80/1392 lm			AH27
AH27 - Square / Ohne Rahmen Square / Senza Cornice 96	17 17.7W	V8 2700K CRI80/1826 lm	AZ Square	OU ON-OFF 100-240V/50-60Hz	WP
		W8 3000K CRI80/1826 lm		DS DALI-2 100-240V/50-60Hz	WQ
		W9 3000K CRI90/1572 lm		BB 36V/Max. 500mA (SC)	
		X8 4000K CRI80/1826 lm			



51

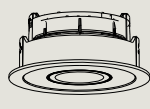

Ø115



51

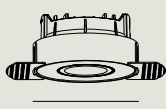

Ø96

Smart Compatible-Zub. / Access. Smart Compatibile

71-A260-00-00 Driver Casambi 350-1050mA 38W (BB)

SIA

Lens Narrow

DIF MAT	IP	2		WELL
PMMA	54	MacAdam		

Codebeispiel / Esempio di codice: AH28-12V8AZOUWR

Model	W	K/ CRI/ Real lm	Optics	Source	Finishes
AH28 - Narrow / Mit Rahmen Narrow / Con cornice 100	12 12W	V8 2700K CRI80/1347 lm	AZ Narrow	OU ON-OFF 100-240V/50-60Hz	AH28
		W8 3000K CRI80/1347 lm		DS DALI-2 100-240V/50-60Hz	WR
		W9 3000K CRI90/1159 lm		BB 36V/Max. 350mA (SC)	WN
		X8 4000K CRI80/1347 lm			AH29
AH29 - Narrow / Ohne Rahmen Narrow / Senza Cornice 96	17 17.7W	V8 2700K CRI80/1757 lm	AZ Narrow	OU ON-OFF 100-240V/50-60Hz	WP
		W8 3000K CRI80/1757 lm		DS DALI-2 100-240V/50-60Hz	WQ
		W9 3000K CRI90/1513 lm		BB 36V/Max. 500mA (SC)	
		X8 4000K CRI80/1757 lm			



51

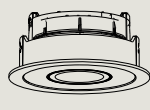

Ø115



51

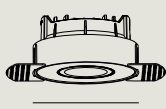



Ø96

Smart Compatible-Zub. / Access. Smart Compatibile

71-A260-00-00 Driver Casambi 350-1050mA 38W (BB)

Biwa

BMLD 2020

BODY MAT	DIF MAT		50000h	2
AL	AL		L80 B20	MacAdam



In Zusammenarbeit zwischen BMLD und LEDS C4 entstand Biwa, ein kleines kompaktes Downlight für die Akzentbeleuchtung. Es bietet die Möglichkeit, dramatische Effekte sowie Hell-Dunkel-Lichtspiele zu erzeugen, wobei Elemente innerhalb eines Raumes präziser beleuchtet werden. Sowohl die Neigung als auch die Drehung des klaren und gestochen scharfen Lichtstrahls ohne Restlicht lassen sich hervorragend einstellen. Dalla collaborazione tra BMLD e LEDS C4, nasce Biwa, un downlight compatto, di piccole dimensioni, progettato per l'illuminazione d'accento. Questo prodotto consente di creare effetti scenici con giochi di chiaroscuro, illuminando gli elementi all'interno di uno spazio, in modo più preciso. Con questo pezzo si proietta un fascio di luce pulito, nitido e privo di residui, offrendo molte possibilità di regolazione dell'inclinazione e della rotazione.

Konzentrierter Winkel in kleiner Größe

Angolo concentrato in
misure ridotte

Trotz ihrer geringen Größe bietet Biwa dank ihres Aufbaus einen sehr konzentrierten Winkel.

La misura ridotta di Biwa non le impedisce di offrire un angolo concentrato grazie alla composizione del pezzo.



Neigungseinstellung Regolazione dell'inclinazione

Biwa bietet eine perfekte Einstellbarkeit des Lichtstrahls und hervorragende Neigungseinstellungen von bis zu 28° seitlich und 350° Drehung.

Biwa permette di controllare perfettamente il fascio di luce ed offre una grande regolazione di inclinazione, fino a 28° laterali e 350° di rotazione.



- ① Von LEDS C4 designer,
hocheffizienter
Kühlkörper
Dissipatore progettato
da LED C4, altamente
efficiente



- ② Optimiertes Linsensystem
Ottimo sistema di lent
- ③ Neigungseinstellung
Regolazione
dell'inclinazione
- ④ Zentrales Diffusorsystem
Sistema di diffusori
centrali

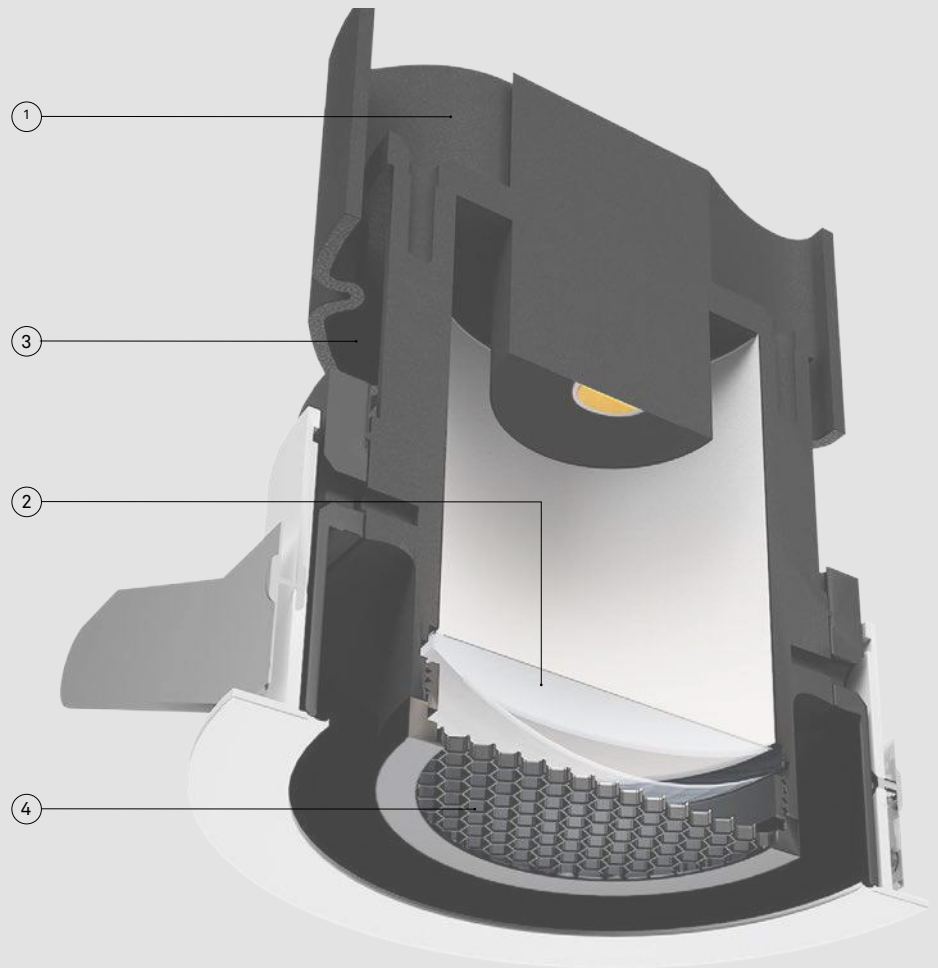

Großes Angebot an Zubehör Ampia gamma di accessori

Für eine individuellere Beleuchtung verfügt die Kollektion über Linsen und Zubehör wie elliptische Diffusoren, quadratische Diffusoren und Wabenraster sowie warme und neutrale Filter, mit denen sich unverkennbare Effekte in den verschiedensten Umgebungen erzielen lassen.

Per una maggior personalizzazione della luce, la collezione dispone di lenti ed accessori come diffusori ellittici, diffusori quadrati e pannello a nido d'ape, oltre a filtri caldi e neutri che permettono di creare effetti concreti, in diversi ambienti.

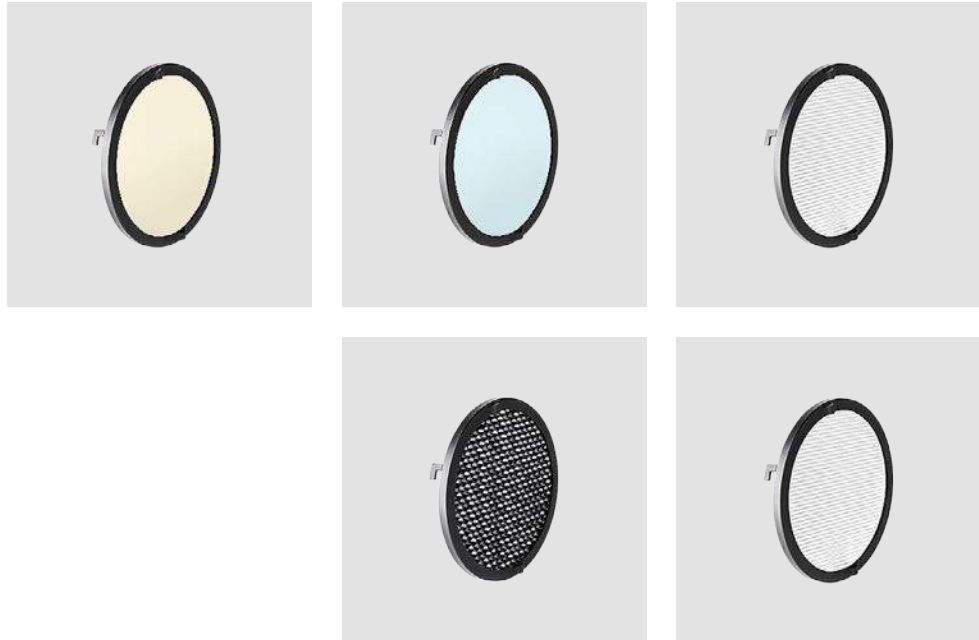

Akzentbeleuchtung und Lichtatmosphären Illuminazione di accento e atmosfere luminose

Die von Biwa erzeugte Akzentbeleuchtung lenkt die visuelle Aufmerksamkeit auf das beleuchtete Objekt und schafft eine einzigartige Atmosphäre und Erfahrung. Mit der Smart-Funktionalität kann die Leuchte gesteuert und es können verschiedene Lichtszenen erzeugt werden.

L'illuminazione di accento prodotta da Biwa concentra l'attenzione visiva sull'oggetto illuminato, creando un'atmosfera e un'esperienza unica, controllabile attraverso la sua funzionalità Smart, creando varie scene luminose.



Traditionelle Beleuchtung
Illuminazione tradizionale

Biwa-Beleuchtung
Illuminazione Biwa

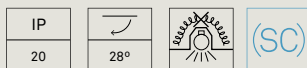

BIWA

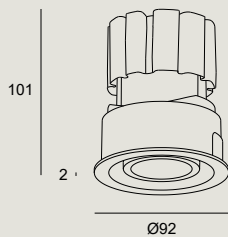

14 



LED						
K	CRI	W LED	W Total	Real Lm	Optics	Code
3000	90	17.5	20	649	Narrow 8°	90-8205 - 14 - OU
3000	90	17.5	20	648	Spot 16°	90-8206 - 14 - DS

	OU	ON-OFF	100-240V	50-60Hz		
	DS	DALI-2	220-240V	50-60Hz		

inklusive / Incluso

Wabenraster
Pannello a nido d'ape

nicht inklusive / Non incluso

Quadratischer Diffusor Diffusore quadrato	71-8224-00-00
Elliptischer Diffusor Diffusore ellittico	71-8226-00-00
Warmer Filter Filtro caldo	71-8227-00-00
Neutraler Filter Filtro neutro	71-8228-00-00

Smart Compatible-Zub. / Access. Smart Compatibile

71-5961-00-00 Dimmer DALI Casambi



Veo

BODY MAT	DIF MAT		50000h	3
PC,AL	PC		L80 B20	MacAdam



Eine Downlight-Kollektion mit verschiedenen Einbaudurchmessern, die für Räume mit unterschiedlichen Verwendungszwecken angepasst werden können und so den Einbau in Decken erleichtern, in denen sich bereits ein Deckenausschnitt befindet.

Collezione di faretti per spazi destinati a vari usi e scopi, che si adatta a diversi diametri di incasso, facilitando così la loro installazione in soffitti dove è esistente un foro precedente.

Maße Misure

Erhältlich in 3 Größen mit 2 Farbtemperaturen (3000 K und 4000 K).

Disponibile in 3 misure e in 2 temperature di colore (3000K e 4000K).



Ø110



Ø161



Ø210

Minimale Einbautiefe Minima profondità di incasso

Aufgrund der geringen Einbautiefe kann das Downlight in niedrige Decken installiert werden.

Il modello consente la sua installazione in soffitti poco profondi poiché è dotato di una profondità di incasso minima.



Wärmeableitung Dissipatore del calore

Veo ist mit einem innovativen Wärmeableiter ausgestattet, der die Wärme auch bei niedriger Höhe effektiv ableiten kann. Vedo si presenta con un dissipatore con un design innovativo che permette di dissipare il calore in modo efficace, malgrado la poca altezza del pezzo.



Adapterrahmen Anello da incasso

Veo bietet einen Adapterrahmen, mit dem die Leuchte schnell und einfach in vom Standardmaß abweichende Einbaulöcher installiert werden kann. Das neue Zubehörteil lässt sich schnell und einfach an der Leuchte anbringen und eröffnet eine Reihe von Installationsmöglichkeiten.

Vedo include un anello che permette di installare il pezzo in fori da incasso di diverse misure, rispetto allo standard. Il nuovo accessorio viene collocato in modo facile e veloce sul pezzo ed apre una serie di possibilità all'installazione.



Ø110- 130



Ø161-180



Ø210-230



Ø110 - 120

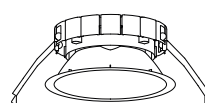

Ø150 - 170

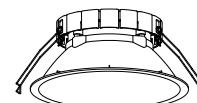

Ø200 - 220

Optimale Wartung Manutenzione ottimale

Durch eine spezielle Behandlung erhält die Leuchte eine hohe Widerstandsfähigkeit gegen Kratzer und Staub, was eine optimale Wartung gewährleistet und einen Schutz für den Einsatz an Orten mit widrigen Bedingungen ermöglicht.

Comprende un trattamento speciale antigraffio, per assicurare la manutenzione ottimale del pezzo, così come antipolvere, che agisce come repellente dello stesso. Può essere installato anche in luoghi dove le condizioni climatiche sono avverse.



Smart-Funktionen: Energieersparnis Funzionalità Smart: Risparmio energetico

Bei der Veo-Kollektion können die Leuchten mit dem entsprechenden Smart-Zubehör je nach Anwesenheit von Personen gesteuert und so unnötiger Energieverbrauch vermieden werden, indem die Leuchte ausgeschaltet oder gedimmt wird.

La collezione Veo, insieme al suo accessorio Smart, permette di controllare gli apparecchi in funzione della presenza, aiutando così a ridurre il consumo energetico non necessario grazie allo spegnimento o alla regolazione della luce.



VEO

Veo Standard



14

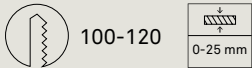
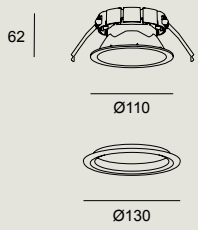

LED						
K	CRI	W LED	W Total	Real Lm	Optics	Code
3000	82	8.6	10	1123	Flood 67°	90-A032 - 14 - 00 DS
4000	82	8.6	10	1123	Flood 67°	90-A033 - 14 - 00 DS

	00	ON-OFF	220-240V	50-60Hz		
	DS	DALI-2	220-240V	50-60Hz		



14

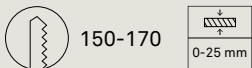
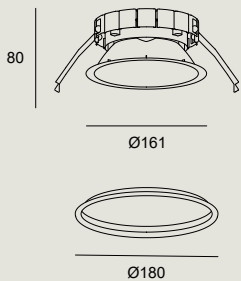

LED						
K	CRI	W LED	W Total	Real Lm	Optics	Code
3000	82	12	13.5	1434	Flood 66°	90-A034 - 14 - 00 DS
4000	82	12	13.5	1477	Flood 66°	90-A035 - 14 - 00 DS

	00	ON-OFF	220-240V	50-60Hz		
	DS	DALI-2/PUSH	220-240V	50-60Hz		



14

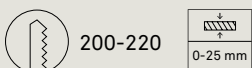
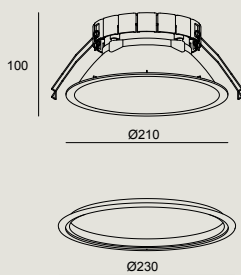

LED						
K	CRI	W LED	W Total	Real Lm	Optics	Code
3000	82	17.5	19.7	1960	Flood 74°	90-A036 - 14 - 00 DS
4000	82	17.5	19.7	2019	Flood 74°	90-A037 - 14 - 00 DS

	00	ON-OFF	220-240V	50-60Hz		
	DS	DALI-2	220-240V	50-60Hz		

mitgeliefertes allgemeines Zub.
Access. comuni inclusi

Zusätzlicher Einbauring zur Anpassung an verschiedene Durchmesser
Occhiello extra per la adattabilità a diversi diámetro

Smart Compatible-Zub.
Access. Smart Compatibile

Dimmer DALI Casambi

71-5961-00-00

VEO

Veo Emergency



14

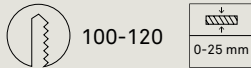
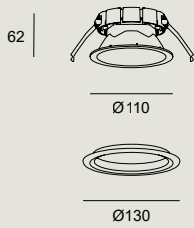

LED K:3000 CRI:82							
W	Real Lm	Real Lm Em	Optics	H Em	Permanent	Auto test	Code
8.6	1123	370	Flood 67°	3	Yes	No	90-A032 - 14 - D3 O3
8.6	1123	380	Flood 67°	3	Yes	No	90-A033 - 14 - D3 O3
D3	DALI-2 Emergency 3H		220-240V	50-60Hz			
O3	ON-OFF Emergency 3H		220-240V	50-60Hz			



14

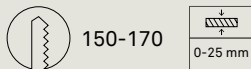
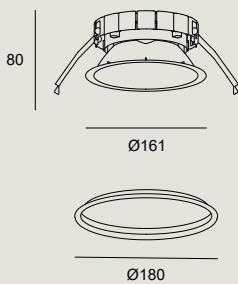

LED K:3000 CRI:82							
W	Real Lm	Real Lm Em	Optics	H Em	Permanent	Auto test	Code
11.9	1434	370	Flood 66°	3	Yes	No	90-A034 - 14 - D3 O3
11.9	1477	380	Flood 66°	3	Yes	No	90-A035 - 14 - D3 O3
D3	DALI-2 Emergency 3H		220-240V	50-60Hz			
O3	ON-OFF Emergency 3H		220-240V	50-60Hz			



14

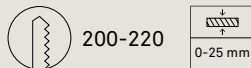
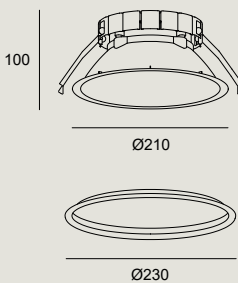

LED K:3000 CRI:82							
W	Real Lm	Real Lm Em	Optics	H Em	Permanent	Auto test	Code
17.5	1960	370	Flood 74°	3	Yes	No	90-A036 - 14 - D3 O3
17.5	2019	380	Flood 74°	3	Yes	No	90-A037 - 14 - D3 O3
D3	DALI-2 Emergency 3H		220-240V	50-60Hz			
O3	ON-OFF Emergency 3H		220-240V	50-60Hz			

mitgeliefertes allgemeines Zub. Access. comuni inclusi

Zusätzlicher Einbauring zur Anpassung an verschiedene Durchmesser Occhiello extra per la adattabilità a diversi diámetro



Vol

BODY MAT	DIF MAT	50000h	3
AL	PMMA	L80 B20	MacAdam



Leistungsstarkes und effizientes Downlight für eine gleichmäßige Grundbeleuchtung.

Un downlight ad alta potenza ed efficienza che offre un'illuminazione generale e uniforme.

Kompakte Größe Dimensioni compatte

Vol bietet ein platzsparendes und kompaktes Design. Aufgrund seiner geringen Höhe eignet es sich ideal für den Einbau in niedrige Decken.

Vol è dotato di un design con dimensioni compatte. La sua ridotta altezza lo rende ideale per installazioni su soffitti poco profondi.



VOL



14

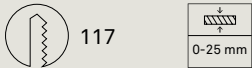
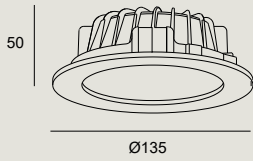

LED					
K	CRI	W LED	W Total	Real Lm	Code
3000	80	8.4	11.9	847	90-4880 - 14 - M3 OE
4000	80	8.4	11.9	888	90-4881 - 14 - M3 OE

M3	ON-OFF	100-240V	50-60Hz		
OE	ON-OFF Emergency 3H	220-240V	50-60Hz		



14

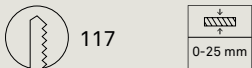
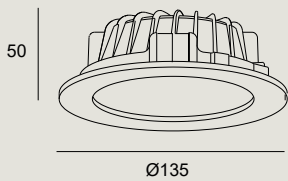

LED Max. 700mA 12V					
K	CRI	W LED	W Total	Real Lm	Code
3000	80	8.4	11.9	847	90-3925 - 14 - M3
4000	80	8.4	11.9	888	90-3926 - 14 - M3

ON-OFF	DALI2/PUSH	1-10V/PUSH	PHASE CUT 240V	CASAMBI (S)
71-6651	71-A190	71-7710	71-7663	71-A261



14

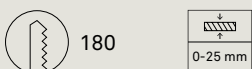
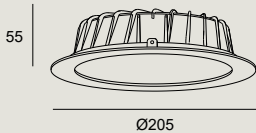

LED					
K	CRI	W LED	W Total	Real Lm	Code
3000	80	16.8	19.5	1934	90-2899 - 14 - M3 OE
4000	80	16.8	19.5	1989	90-4883 - 14 - M3 OE

M3	ON-OFF	100-240V	50-60Hz		
OE	ON-OFF Emergency 3H	220-240V	50-60Hz		

VOL



14

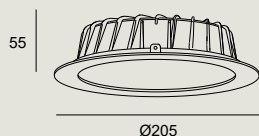

LED Max. 700mA 24V					
K	CRI	W LED	W Total	Real Lm	Code
3000	80	16.8	19.5	1934	90-3927 - 14 - M3
4000	80	16.8	19.5	1989	90-3928 - 14 - M3
ON-OFF	CASAMBI	DALI2/PUSH	1-10V/PUSH	PHASE CUT 240V	
71-6658	71-A261	71-A192	71-7710	71-A299	

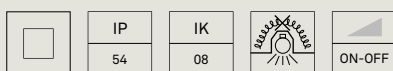
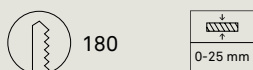

14

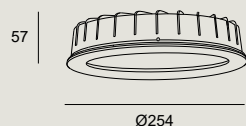

LED					
K	CRI	W LED	W Total	Real Lm	Code
3000	80	25.4	30.2	3012	90-4885 - 14 - M3 OE
4000	80	25.4	30.2	3109	90-4886 - 14 - M3 OE
M3 ON-OFF			100-240V 50-60Hz		
OE ON-OFF Emergency 3H			220-240V 50-60Hz		

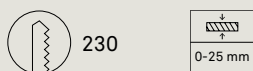

14

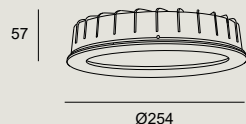

LED Max. 700mA 36V					
K	CRI	W LED	W Total	Real Lm	Code
3000	80	25.4	30.2	3012	90-3929 - 14 - M3
4000	80	25.4	30.2	3109	90-3930 - 14 - M3
ON-OFF	1-10V/PUSH	CASAMBI	DALI2/PUSH	PHASE CUT 240V	
71-6653	71-4708	71-A260	71-A192	71-A299	

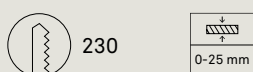



Play

BODY MAT	DIF MAT		50000h	3
PUR	PC		L80 B20	MacAdam



Play ist die modularste Produktlinie auf dem Markt. Mit den LED-Optionen mit 1, 5, 3, 7, 13 oder 18 W lassen sich eine Vielzahl von Rahmen und Zubehörteilen integrieren und kombinieren. Auf diese Weise erhalten Sie ein 100 % kundenspezifisches Downlight für jede Situation. Zudem gibt es vier Optiken mit verschiedenen Öffnungswinkeln von Ultra Narrow (7°) bis Ultra Spot (50°), drei Farbtemperaturen (2700 K, 3000 K und 4000 K) und die Optionen Warm-Dimming und Tunable White.

Play è la collezione di downlight più modulare, esistente nel mercato. Dispone di diversi moduli led di 1.5, 3, 7, 13 e 18W a cui è possibile aggiungere un'ampia varietà di cornici ed accessori, ottenendo così il downlight necessario per ogni situazione. Dispone, inoltre, di 4 ottiche, con diverse aperture, che vanno da Ultra Narrow -7°- a Ultra Spot -50°- ed è proposto in 3 temperature di colore: 2700, 3000K, 4000K, oltre alle opzioni Warm-Dimming e Tunable White.



① **Module**
Moduli

1,5W
3W
7W
13W
18W
Warm Dimming 13W
Tunable White 13W
Emergency 7W



② **Optionales Zubehör**
Accessori opzionali

Eliptical Diffuser
Square Diffuser
Honeycomb
Softening Lens
Visual Comfort
Screen



③ **Marcos**
Molduras

Flat
Deep
High Visual Comfort
IP65
IP65 Glass
Pinhole
Soft
Snoot
Raw Racy Gold
Raw Walnut
Raw Oak
Raw Alabastre
Raw Concrete
Deco Symmetrical
Deco Asymmetrical
Deco Double



Vollständige Modularität Modularité totale

Diese hohe Konfigurations- und Leistungsfähigkeit ermöglicht es, eine Leuchte mehr als 40.000 Optionen zu gestalten, um sie an die Beleuchtungsanforderungen jedes Projekts anzupassen. Zusätzlich wird ein sehr hoher visueller Komfort dank eines UGR von weniger als 13 und einer hohen Farbwiedergabe mit einem CRI90 oder höher erreicht.

Questa grande capacità di configurazione e performance consente di modellare un apparecchio con oltre 40.000 opzioni; adattandosi così alle esigenze di illuminazione di qualsiasi progetto, a cui si aggiunge un comfort visivo davvero elevato grazie a un UGR inferiore a 13 e un'importante resa cromatica con CRI90 o superiore.

Linsen für bessere Lichtsteuerung Lenti per un maggior controllo della luce



Honeycomb

Steigert den Sehkomfort und betont den Austrittswinkel.

Honeycomb

Aumenta il comfort e risalta l'angolo di uscita.



Elliptischer Diffusor

Verändert den Lichtaustritt und verlängert ihn. Ideal für Flure.

Diffusore ellittico

Modifica il fascio di luce per allungarlo. È ideale per corridoi.



Quadratischer Diffusor

Verändert den Lichtaustritt und formt ihn quadratisch, so dass die Beleuchtung besser an die jeweilige Raumsituation angepasst werden kann.

Diffusore quadrato

Modifica il fascio di luce e lo rende quadrato, consentendo una miglior adattabilità dell'illuminazione agli spazi.



Weichzeichnerlinse

Macht den Lichtaustritt weniger definiert und erzeugt einen Unschärfeeffekt.

Diffusore dell'alone

Fa sì che l'uscita della luce non abbia un angolo così marcato e crea un effetto sfumato.

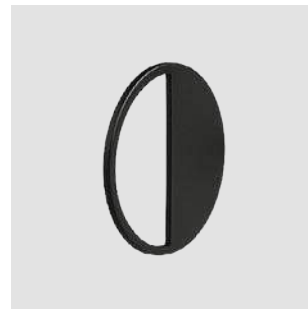

Screen

Ermöglicht die Lenkung des Lichtaustritts und das Ausrichten des Lichts, um eine Wand zu beleuchten, ohne den Boden zu beleuchten, oder umgekehrt.

Screen

Permette di controllare l'uscita della luce e di ritagliare l'alone per illuminare una parete, senza illuminare il pavimento o viceversa.



Visual Comfort

Erhöht den Sehkomfort und senkt den UGR (den Blendwert).

Visual comfort

Aumenta il comfort e diminuisce l'UGR e l'abbagliamento.

**Edle Materialien und trendige
Ausführungen**
Materiali nobili e finiture di
tendenza

Die Vielseitigkeit dieser Leuchte zeigt sich nicht nur in den Modulen, sondern auch bei ihren Rahmen. Edle und trendige Ausführungen wie Alabaster, das Transparenz und diffuses Licht erzeugt, oder Eichen- und Nussbaumholz, das Wärme und Eleganz in den Raum bringt sowie auch Zement, der eine vollständige Anpassung an architektonische und industrielle Räume ermöglicht. Des Weiteren stehen auch zweifarbige Rahmen in Weiß, Schwarz und dem exklusiven Raw Racy Gold in den Modellen Deco Symmetrical und Deco Asymmetrical in Kombination zur Auswahl.

La versatilità di questo prodotto si presenta non solo nei moduli, ma anche nelle cornici, che includono finiture nobili e di tendenza; tra queste finiture, l'alabastro, che genera trasparenze ed una luce diffusa, il legno di rovere e di noce, che apporta calore ed eleganza allo spazio e, il cemento, che facilita la totale integrazione in spazi architettonici ed industriali. Il prodotto offre, inoltre, la possibilità di scegliere cornici bicolori combinando il bianco, il nero e l'esclusivo dorato Raw Racy Gold, nei modelli Deco Symmetrical e Deco Asymmetrical.



Exklusives Notfallmodul
Modulo di emergenza esclusivo

Von C4 LEDS patentiertes System zur Anzeige des Leuchtenzustands, bei dem die Notlichtanzeige in die Optik integriert ist, wodurch ein Projekt einheitlicher gestaltet werden kann. Sistema di segnalazione dello stato dell'apparecchio brevettato da LEDS C4 con l'indicatore di emergenza incluso nella stessa ottica, che consente una maggiore omogeneizzazione del progetto.



Tunable White

Play bietet Tunable White-Versionen, bei denen die Farbtemperatur über ein Steuerungssystem punktuell oder über ein Zeitprogramm zur Simulation von natürlichem Licht reguliert werden kann, um so den menschlichen circadianen Rhythmus zu unterstützen.

Play offre versioni Tunable White che permettono, tramite un sistema di controllo, di regolare la temperatura di colore puntualmente o attraverso una programmazione oraria per simulare la luce naturale, potendo così aiutare il ciclo circadiano delle persone.



INDOOR DOWNLIGHTS / DOWNLIGHTS

Smart-Funktionen: Zeitliche Programmierung Funzionalità Smart: Programmazioni orarie

Durch den Einsatz von Steuerungslösungen kann die Beleuchtung an die jeweiligen Bedürfnisse angepasst werden, sei es durch die Steuerung der Beleuchtung zur Steigerung der Energieeffizienz oder durch Lichtszenen, die dem Raum Dynamik und Flexibilität verleihen.

Con l'aggiunta di soluzioni di connettività, questa collezione permette di adattare l'installazione in base alle esigenze del momento, sia regolando l'illuminazione per aumentare l'efficienza energetica, sia con scene luminose che offrano dinamismo e flessibilità allo spazio.



Code-Konfigurator Configuratore di codici



Konfigurieren Sie Ihre Leuchte
Configura il tuo apparecchio

LEDS C4 bietet ein Online-Tool, mit dem ein vollständig kundenspezifischer und maßgeschneiderter Code erstellt und konfiguriert werden kann, wobei aus allen verfügbaren Optionen von Modulen, Rahmen und Zubehör ausgewählt werden kann.

LEDS C4 dispone di uno strumento online che permette di creare e configurare un codice completamente personalizzato e su misura, scegliendo tra tutte le opzioni di moduli, cornici ed accessori disponibili.

play.leds-c4.com



1. Auswahl nach Modulen oder Rahmenmodellen
Selezione per moduli o modelli di cornice

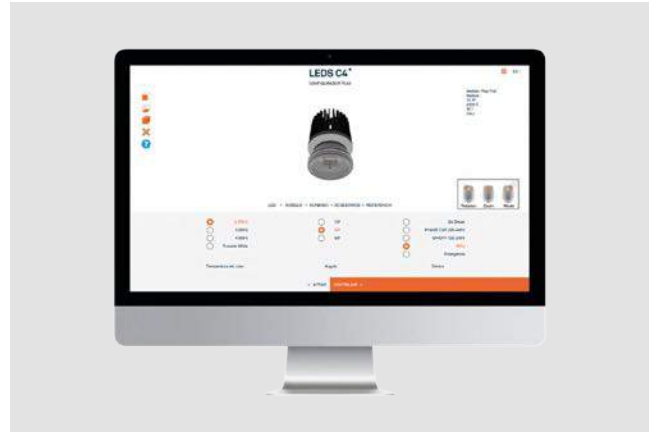

2. Auswahl des optischen Moduls und der Steuerungsart
Selezione del modulo ottico e del tipo di regolazione

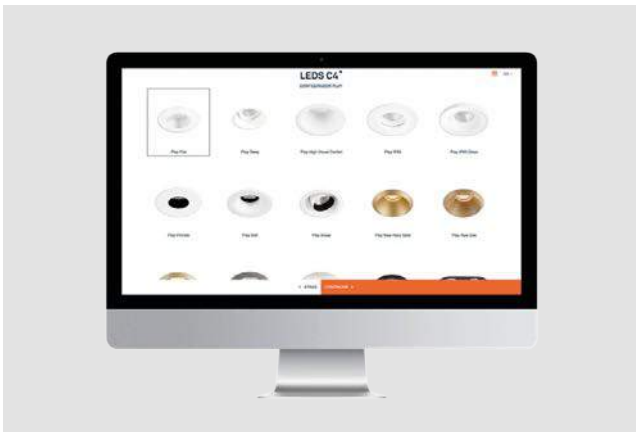

3. Rahmenauswahl
Selezione della cornice

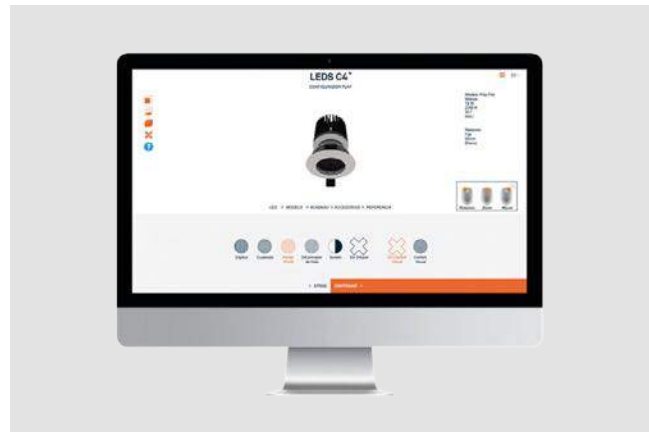

4. Zubehörauswahl
Selezione degli accessori

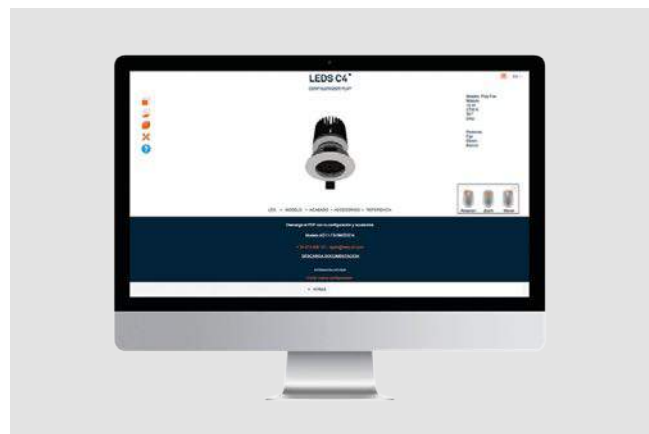

5. Erstellung des Codes
Ottenimento codice

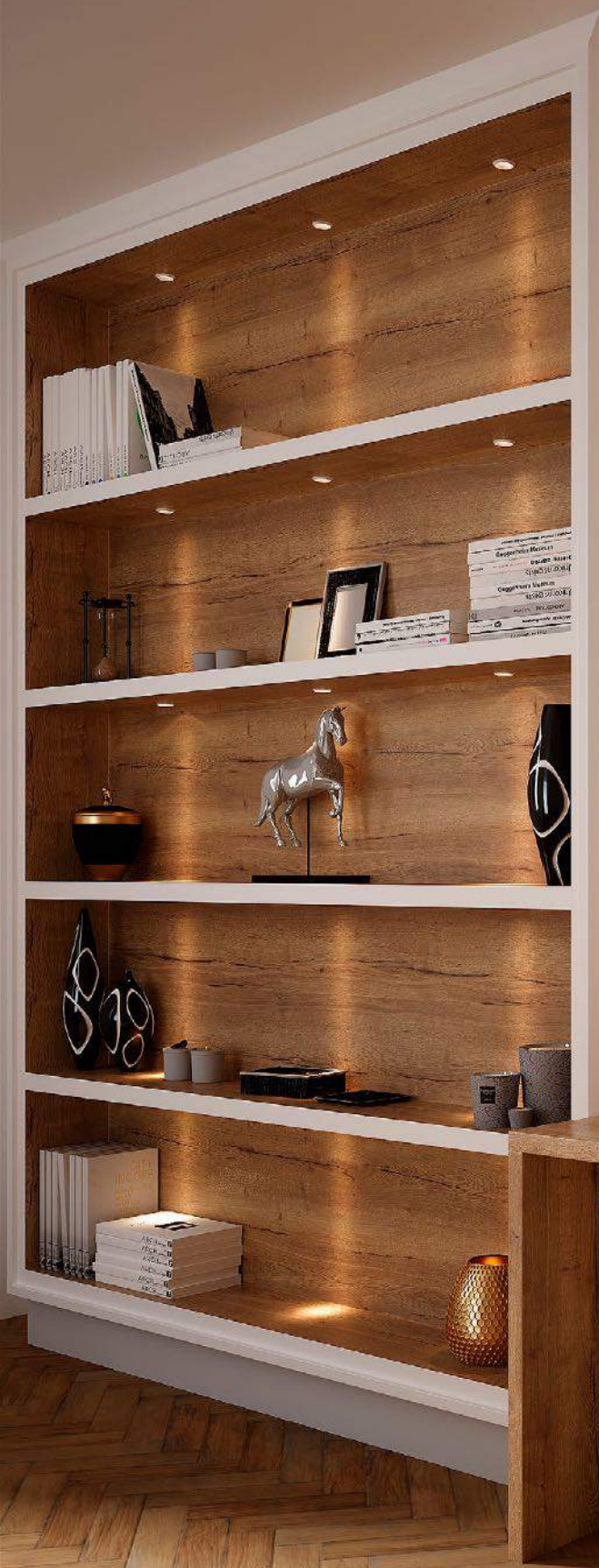

MODULES
MODULI

1,5W



Spot

3W



Medium - Flood

7W



Spot - Medium - Flood



Emergency 7W



Spot - Medium - Flood



13 W



Spot - Medium - Flood



Warm Dimming
Tunable White



Spot - Medium - Flood



18 W



Spot - Medium - Flood



Kit GU10



RAHMEN CORNICI

Flat P. 206

Idealer Rahmen für Installationen mit minimaler Einbauhöhe.
Cornice ideale per installazioni con altezza minima da incasso.

Deep P. 208

Tiefer Rahmen mit geringer Größe und hohem Komfort.
Cornice profonda di dimensioni ridotte, con grande comfort.

Fest / Fisso

Schwenkbar / Regolabile

Fest / Fisso

Schwenkbar / Regolabile



Ø 45 mm



Ø 65 mm



Ø 65 mm



Ø 85 mm



Ø 78 mm



Ø 75 mm

1,5W / 3W
7W / 13W / 18W
Warm Dimming 13W
Tunable White 13W
Emergency 7W



Mit Rahmen / Trim
Randlos / Trimless

14 ○ 60 ● AF ●

7W / 13W / 18W
Warm Dimming 13W
Tunable White 13W
Emergency 7W



Mit Rahmen / Trim
Randlos / Trimless

14 ○ 60 ●

Nicht alle Rahmenmodelle sind mit allen Merkmalen kompatibel. Siehe Details auf der Seite des Modells.
Non tutti i modelli di cornici sono compatibili con tutte le caratteristiche. Per ulteriori informazioni vedere la pagina del modello. Ver detalhe na página do modelo.

High visual comfort

P. 209

Rahmen mit zusätzlichem Komfort und vermindertem UGR.
Cornice con un plus di comfort ed un fattore UGR ridotto.

IP65

P. 211

Idealer Rahmen für Bereiche mit hoher Luftfeuchtigkeit.
Cornice ideale per aree con atmosfera umida.

IP65 Glass

P. 213

Rahmen mit Glasverzierung, ideal für Bereiche mit hoher Luftfeuchtigkeit.
Cornice con finiture in vetro, ideale per aree con atmosfera umida.

Fest / Fisso

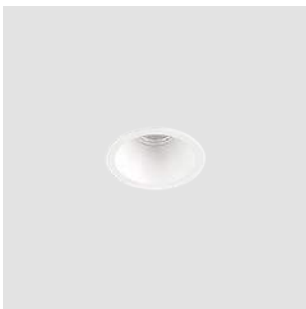

Ø 45 mm

Schwenkbar / Regolabile



Ø 50 mm

Fest / Fisso



Ø 93 mm

Fest / Fisso



Ø 92 mm



Ø 90 mm



Ø 100 mm

1,5W / 3W
7W / 13W / 18W
Warm Dimming 13W
Tunable White 13W
Emergency 7W



Mit Rahmen / Trim
Randlos / Trimless

14 ○ 60 ●

1,5W / 3W
7W / 13W / 18W
Warm Dimming 13W
Tunable White 13W
Emergency 7W



Mit Rahmen / Trim
Randlos / Trimless

14 ○ 60 ● 21 ●

7W / 13W / 18W
Warm Dimming 13W
Tunable White 13W
Emergency 7W



Mit Rahmen / Trim
Randlos / Trimless

14 ○

Nicht alle Rahmenmodelle sind mit allen Merkmalen kompatibel. Siehe Details auf der Seite des Modells.

Non tutti i modelli di cornici sono compatibili con tutte le caratteristiche. Per ulteriori informazioni vedere la pagina del modello. Ver detalhe na página do modelo.

Pinhole

P. 215

Rahmen für Installationen, bei denen der Lichtpunkt nicht auffallen darf.

Cornice per installazioni dove il punto luce debba passare inosservato.

Soft

P. 216

Rahmen mit geglätteter Konusstruktur für eine bessere Integration in die Decke.

Cornice con struttura conica levigata, per una maggiore integrazione nel soffitto.

Fest / Fisso

Schwenkbar / Regolabile

Fest / Fisso

Schwenkbar / Regolabile

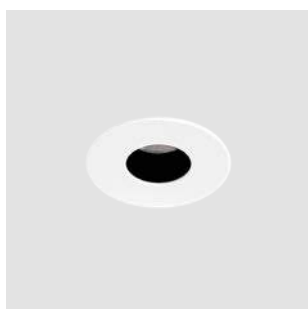

Ø 65 mm

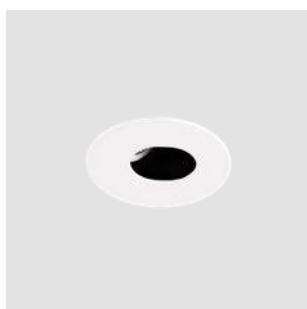

Ø 65 mm



Ø 65 mm

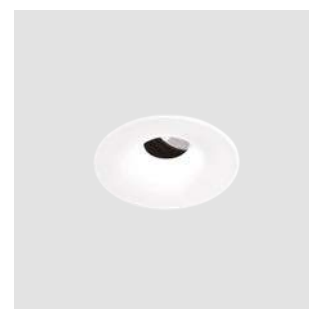

Ø 65 mm

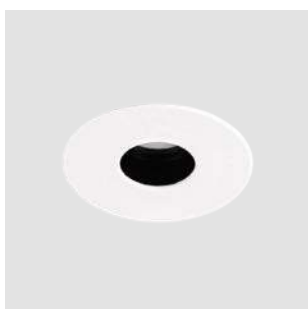

Ø 88 mm

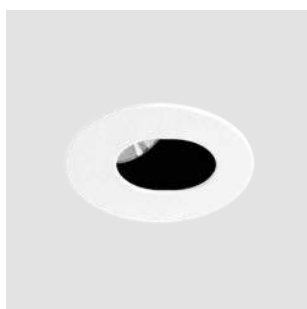

Ø 88 mm



Ø 95 mm



Ø 95 mm

1,5W / 3W
7W / 13W / 18W
Warm Dimming 13W
Tunable White 13W
Emergency 7W



Mit Rahmen / Trim
Randlos / Trimless

14 ○ 60 ●

1,5W / 3W
7W / 13W / 18W
Warm Dimming 13W
Tunable White 13W
Emergency 7W



Mit Rahmen / Trim
Randlos / Trimless

14 ○ 60 ●

Nicht alle Rahmenmodelle sind mit allen Merkmalen kompatibel. Siehe Details auf der Seite des Modells.

Non tutti i modelli di cornici sono compatibili con tutte le caratteristiche. Per ulteriori informazioni vedere la pagina del modello. Ver detalhe na página do modelo.

Snoot

P. 219

Rahmen für hohen Komfort und maximale Einstellbarkeit.

Cornice che offre un alto comfort e una massima regolazione.

Schwenkbar / Regolabile



Ø 70 mm



Ø 95 mm

1,5W / 3W
7W / 13W / 18W
Warm Dimming 13W
Tunable White 13W
Emergency 7W



Mit Rahmen / Trim
Randlos / Trimless

14 ○ 60 ●

Raw Racy Gold

P. 221

Dekorativer Rahmen mit goldenem Essence-Finish.

Cornice decorativa rifinita in oro Essence.

Fest / Fisso



Ø 65 mm



Ø 110 mm

1,5W / 3W
7W / 13W / 18W
Warm Dimming 13W
Tunable White 13W
Emergency 7W



Mit Rahmen / Trim
Randlos / Trimless

EP ●

Raw Walnut

P. 221, 223

Dekorativer Rahmen aus Nussbaumholz, um dem Raum mehr Wärme zu verleihen.

Cornice decorativa in noce, che conferisce maggiore calore allo spazio.

Fest / Fisso



Ø 65 mm



Ø 110 mm

1,5W / 3W
7W / 13W / 18W
Warm Dimming 13W
Tunable White 13W
Emergency 7W



Mit Rahmen / Trim
Randlos / Trimless

EN ●

Nicht alle Rahmenmodelle sind mit allen Merkmalen kompatibel. Siehe Details auf der Seite des Modells.

Non tutti i modelli di cornici sono compatibili con tutte le caratteristiche. Per ulteriori informazioni vedere la pagina del modello. Ver detalhe na página do modelo.

Raw Oak

P. 221, 223

Dekorativer Rahmen aus Eichenholz, um dem Raum mehr Wärme zu verleihen.

Cornice decorativa in rovere, che offre maggiore calore allo spazio.

Fest / Fisso



Ø 65 mm



Ø 110 mm

1,5W / 3W
7W / 13W / 18W
Warm Dimming 13W
Tunable White 13W
Emergency 7W



Mit Rahmen / Trim
Randlos / Trimless

EN

Raw Alabaster

P. 221, 223

Dekorativer Rahmen aus Alabaster, um durch Lichtstreuung ein exklusives Ambiente zu erzeugen.

Cornice decorativa in alabastro, che conferisce esclusività, oltre a una luce diffusa nell'ambiente.

Fest / Fisso

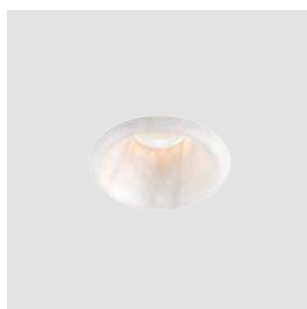

Ø 65 mm



Ø 110 mm

7W / 13W / 18W
Warm Dimming 13W
Tunable White 13W
Emergency 7W



Mit Rahmen / Trim
Randlos / Trimless

55

Raw Concrete

P. 223

Dekorativer Rahmen aus Zement, der perfekt in architektonische und industrielle Räume integriert werden kann.

Cornice decorativa in cemento che si integra perfettamente negli spazi architettonici ed industriali.

Fest / Fisso



Ø 110 mm

1,5W / 3W
7W / 13W / 18W
Warm Dimming 13W
Tunable White 13W
Emergency 7W



Mit Rahmen / Trim
Randlos / Trimless

DC

Nicht alle Rahmenmodelle sind mit allen Merkmalen kompatibel. Siehe Details auf der Seite des Modells.
Non tutti i modelli di cornici sono compatibili con tutte le caratteristiche. Per ulteriori informazioni vedere la pagina del modello. Ver detalhe na página do modelo.

Deco Symmetrical

P. 225

Dekorativer Rahmen mit der Möglichkeit, zwei Oberflächen zu kombinieren.

Cornice decorativa asimmetrica, con possibilità di combinare due finiture.

Fest / Fisso

Deco Asymmetrical

P. 226

Dekorativer asymmetrischer Rahmen mit der Möglichkeit, zwei Oberflächen zu kombinieren.

Cornice decorativa asimmetrica, con possibilità di combinare due finiture.

Fest / Fisso

Deco Double

P. 228

Dekorativer Rahmen mit zwei Lichtpunkten, die unabhängig voneinander ausgerichtet werden können.

Cornice decorativa che incorpora due punti luce, regolabili indipendentemente.

Schwenkbar / Regolabile

Deco Surface

P. 229

Zylindrische Struktur für die Montage auf der Oberfläche mit der Möglichkeit, zwei Ausführungen zu kombinieren.

Struttura cilindrica per l'installazione in superficie, con possibilità di combinare due finiture.

Fest / Fisso

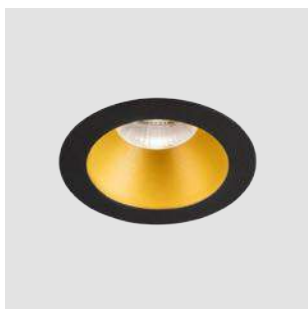

Ø 90 mm

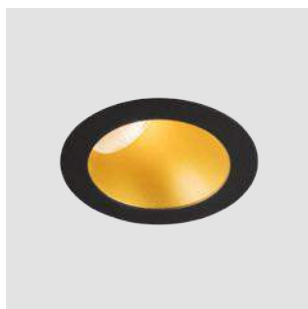

Ø 90 mm



Ø 103 x 196 mm



Ø 72,5 mm

7W / 13W / 18W
Warm Dimming 13W
Tunable White 13W
Emergency 7W

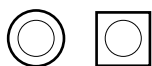

Mit Rahmen / Trim
Randlos / Trimless

14 ○ 60 ● 23 ●

7W / 13W / 18W
Warm Dimming 13W
Tunable White 13W
Emergency 7W



Mit Rahmen / Trim
Randlos / Trimless

14 ○ 60 ● 23 ●

7W / 13W / 18W
Warm Dimming 13W
Tunable White 13W
Emergency 7W



Mit Rahmen / Trim
Randlos / Trimless

14 ○ 60 ● 23 ●

7W / 13W



14 ○

Nicht alle Rahmenmodelle sind mit allen Merkmalen kompatibel. Siehe Details auf der Seite des Modells.

Non tutti i modelli di cornici sono compatibili con tutte le caratteristiche. Per ulteriori informazioni vedere la pagina del modello. Ver detalhe na página do modelo.

Erstellen Sie Ihren Code, um das komplette Produkt zu erhalten
Comporre il proprio codice ed ottenere il riferimento completo

Sie können das Modell Play in der Tabelle der Artikelkombination individuell anpassen und erhalten:
 – Ein einziges Produkt
 – Ein einziges Datenblatt.

Personalizzare il modello Play tramite la tabella di composizione dei codici di riferimento ottenendo:
 – Un solo codice.
 – Una sola scheda tecnica.

Codebeispiel / Esempio di codice: AG11-P7V9S2OU14

Codebeispiel / Esempio di codice: AG11-P7V9S2OU14

Model	W	K/ CRI/ Real lm	Optics	Source	Finishes												
 <p>AG11 - Rund / Fest Rotondo / Fisso Ⓜ 58 IP54</p> <table border="1"> <thead> <tr> <th>W</th> <th>X</th> </tr> </thead> <tbody> <tr> <td>7 W</td> <td>65</td> </tr> <tr> <td>13 W</td> <td>85</td> </tr> <tr> <td>18 W</td> <td>105</td> </tr> <tr> <td>Warm-dim</td> <td>100</td> </tr> <tr> <td>GU10 MR16*</td> <td>75</td> </tr> </tbody> </table>	W	X	7 W	65	13 W	85	18 W	105	Warm-dim	100	GU10 MR16*	75	P7 6,4W	V9 2700K/CRI90 529 lm	S2 15°	OU  ON-OFF/100-240V 50-60Hz	14  60  ONLY FOR AG12 AF 
	W	X															
	7 W	65															
13 W	85																
18 W	105																
Warm-dim	100																
GU10 MR16*	75																
W9 3000K/CRI90 663 lm	M2 28°	TS  PHASE CUT 220-240V 50-60Hz															
X9 4000K/CRI90 651 lm	F1 49°	DS  DALI-2/220-240V 50-60Hz BB  9V/Max. 700mA															
 <p>AG12 - Rund / Schwenkbar Rotondo / Regolabile Ⓜ 68 IP23</p> <table border="1"> <thead> <tr> <th>W</th> <th>X</th> </tr> </thead> <tbody> <tr> <td>7 W</td> <td>70</td> </tr> <tr> <td>13 W</td> <td>90</td> </tr> <tr> <td>18 W</td> <td>110</td> </tr> <tr> <td>Warm-dim</td> <td>105</td> </tr> <tr> <td>GU10 MR16*</td> <td>80</td> </tr> </tbody> </table>	W	X	7 W	70	13 W	90	18 W	110	Warm-dim	105	GU10 MR16*	80	13 11,9W	V9 2700K CRI90/957 lm	S2 22°	OU  ON-OFF/100-240V 50-60Hz	
	W	X															
	7 W	70															
13 W	90																
18 W	110																
Warm-dim	105																
GU10 MR16*	80																
W9 3000K/CRI90 1330 lm	M2 34°	TS  PHASE CUT 220-240V 50-60Hz															
X9 4000K/CRI90 1387 lm	F1 44°	DS  DALI-2/220-240V 50-60Hz BB  36V/Max. 350mA															
 <p>AG19 - Quadratisch / Fest Quadrato / Fisso Ⓜ 58x58 IP54</p> <table border="1"> <thead> <tr> <th>W</th> <th>X</th> </tr> </thead> <tbody> <tr> <td>7 W</td> <td>65</td> </tr> <tr> <td>13 W</td> <td>85</td> </tr> <tr> <td>18 W</td> <td>105</td> </tr> <tr> <td>Warm-dim</td> <td>100</td> </tr> <tr> <td>GU10 MR16*</td> <td>75</td> </tr> </tbody> </table>	W	X	7 W	65	13 W	85	18 W	105	Warm-dim	100	GU10 MR16*	75	18 17.7W	V9 2700K/CRI90 1689 lm	S2 22°	OU  ON-OFF/100-240V 50-60Hz	
	W	X															
	7 W	65															
13 W	85																
18 W	105																
Warm-dim	100																
GU10 MR16*	75																
W9 3000K/CRI90 1707 lm	M2 34°	TS  PHASE CUT 220-240V 50-60Hz															
X9 4000K/CRI90 1657 lm	F1 51°	DS  DALI-2/220-240V 50-60Hz BB  36V/Max. 500mA															
 <p>AG21 - Quadratisch / Schwenkbar Quadrato / Regolabile Ⓜ 68x68 IP23</p> <table border="1"> <thead> <tr> <th>W</th> <th>X</th> </tr> </thead> <tbody> <tr> <td>7 W</td> <td>70</td> </tr> <tr> <td>13 W</td> <td>90</td> </tr> <tr> <td>18 W</td> <td>110</td> </tr> <tr> <td>Warm-dim</td> <td>105</td> </tr> <tr> <td>GU10 MR16*</td> <td>80</td> </tr> </tbody> </table>	W	X	7 W	70	13 W	90	18 W	110	Warm-dim	105	GU10 MR16*	80	13 11.9W	S9 Warm Dimming 1800K - 3500K CRI 95/947 lm	S2 19°	TS  PHASE CUT 220-240V 50-60Hz	
	W	X															
	7 W	70															
13 W	90																
18 W	110																
Warm-dim	105																
GU10 MR16*	80																
12 12.5W	U9 TW 2700K-6500K CRI90/1068 lm	M2 33°	TW  DALI DT8 220-240V 50-60Hz														
AA GU10	G1	F1 45°	BU  220-240V 50-60Hz														







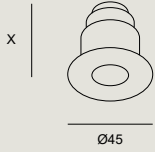

 P. 940

PLAY

Flat Mini

BODY MAT	50000h	WELL
AL	L80 B20	

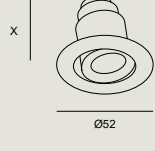
Codebeispiel / Esempio di codice: AG33-P2V8S1OU14

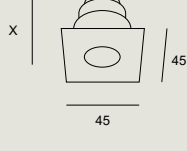



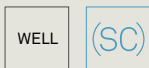

Model	W	K/CRI/Real lm	Optics	Source	Finishes						
 <p>AG33 - Rund / Fest Rotondo / Fisso ① 40 IP54</p> <table border="1"> <tr> <th>W</th> <th>X</th> </tr> <tr> <td>1,5 W</td> <td>40</td> </tr> <tr> <td>3 W</td> <td>30</td> </tr> </table>  <p>Ø45</p>	W	X	1,5 W	40	3 W	30	P2 1,5W	V8 2700K/CRI80 116 lm	S1 7°	OU  ON-OFF 100-277V 50-60Hz	14  60  ONLY FOR AG34 AF 
	W	X									
	1,5 W	40									
	3 W	30									
	W8 3000K/CRI80 116 lm	BB  3V/Max. 500mA									
	X8 4000K/CRI80 115 lm										
P3 3.2W	V8 2700K/CRI80 349 lm	M2 29°	OU  ON-OFF 100-277V 50-60Hz								
W8 3000K/CRI80 319 lm	F1 47°	BB  9V/Max. 350mA									
X8 4000K/CRI80 343 lm											
 <p>AG34 - Rund / Schwenkbar Rotondo / Regolabile ① 42 IP23</p> <table border="1"> <tr> <th>W</th> <th>X</th> </tr> <tr> <td>1,5 W</td> <td>45</td> </tr> <tr> <td>3 W</td> <td>35</td> </tr> </table>  <p>Ø52</p>	W	X	1,5 W	45	3 W	35					
	W	X									
1,5 W	45										
3 W	35										
 <p>AG38 - Quadratisch / Fest Quadrato / Fisso ① 40x40 IP54</p> <table border="1"> <tr> <th>W</th> <th>X</th> </tr> <tr> <td>1,5 W</td> <td>40</td> </tr> <tr> <td>3 W</td> <td>30</td> </tr> </table>  <p>45</p>	W	X	1,5 W	40	3 W	30					
	W	X									
1,5 W	40										
3 W	30										
 <p>AG39 - Quadratisch / Schwenkbar Quadrato / Regolabile ① 42x42 IP23</p> <table border="1"> <tr> <th>W</th> <th>X</th> </tr> <tr> <td>1,5 W</td> <td>45</td> </tr> <tr> <td>3 W</td> <td>35</td> </tr> </table>  <p>52</p>	W	X	1,5 W	45	3 W	35					
	W	X									
1,5 W	45										
3 W	35										

 P.940

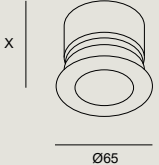
nicht inklusive / Non incluso

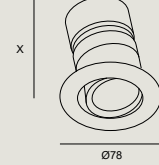
Beton-Unterputzset Ø 40-42 / Kit incasso in cemento Ø 40-42	71-5618-60-00
Visueller Komfort Weiß / Comfort visivo bianco	71-4754-14-00
Visueller Komfort Schwarz / Comfort visivo nero	71-4754-60-00
Wabenraster x 5 / Pannello a nido d'ape (5 unità)	71-5166-60-00
Elliptischer Diffusor x 5 / Diffusore ellittico (5 unità)	71-5167-00-00
Quadratischer Diffusor x 5 / Diffusore quadrato (5 unità)	71-5658-00-00
Weichzeichnerlinse x 5 / Sagomatore di fascio (5 unità)	71-6099-00-00
Schirm x 5 / Screen x 5	71-7895-60-00

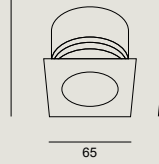

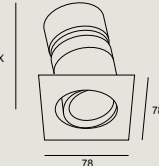
Model	W	K/ CRI/ Real lm	Optics	Source	Finishes
 AG11 - Rund / Fest Rotondo / Fisso Ø 58 IP54 	P7 6,4W	V9 2700K/CRI90 529 lm	S2 15°	OU ON-OFF/100-240V 50-60Hz	14 60 ONLY FOR AG12 AF
		W9 3000K/CRI90 663 lm	M2 28°	TS PHASE CUT 220-240V 50-60Hz	
		X9 4000K/CRI90 651 lm	F1 49°	DS DALI-2/220-240V 50-60Hz BB 9V/Max. 700mA	
 AG12 - Rund / Schwenkbar Rotondo / Regolabile Ø 68 IP23 	13 11,9W	V9 2700K CRI90/957 lm	S2 22°	OU ON-OFF/100-240V 50-60Hz	01 Emergency ON-OFF 1H 220-240V 50-60Hz 03 Emergency ON-OFF 3H 220-240V/ 50-60Hz D1 Emergency DALI-2 1H 220-240V/ 50-60Hz D3 Emergency DALI-2 3H/220-240V 50-60Hz
		W9 3000K/CRI90 1330 lm	M2 34°	TS PHASE CUT 220-240V 50-60Hz	
		X9 4000K/CRI90 1387 lm	F1 44°	DS DALI-2/220-240V 50-60Hz BB 36V/Max. 350mA	
 AG19 - Quadratisch / Fest Quadrato / Fisso 58x58 IP54 	18 17.7W	V9 2700K/CRI90 1689 lm	S2 22°	OU ON-OFF/100-240V 50-60Hz	01 Emergency ON-OFF 1H 220-240V/ 50-60Hz 03 Emergency ON-OFF 3H 220-240V/50-60Hz D1 Emergency DALI-2 1H/220-240V 50-60Hz D3 Emergency DALI-2 3H/220-240V 50-60Hz
		W9 3000K/CRI90 1707 lm	M2 34°	TS PHASE CUT 220-240V 50-60Hz	
		X9 4000K/CRI90 1657 lm	F1 51°	DS DALI-2/220-240V 50-60Hz BB 36V/Max. 500mA	
 AG21 - Quadratisch / Schwenkbar Quadrato / Regolabile 68x68 IP23 	13 11.9W	S9 Warm Dimming 1800K - 3500K CRI 95/947 lm	S2 19°	TS PHASE CUT 220-240V 50-60Hz	TW DALI DT8 220-240V 50-60Hz
	12 12.5W	U9 TW 2700K-6500K CRI90/1068 lm	M2 33°	F1 45°	
	AA GU10	G1	NA	BU 220-240V 50-60Hz	

nicht inklusive / Non incluso	
Visueller Komfort Weiß / Comfort visivo bianco	71-4754-14-00
Visueller Komfort Schwarz / Comfort visivo nero	71-4754-60-00
Wabenraster x 5 / Pannello a nido d'ape (5 unità)	71-5166-60-00
Elliptischer Diffusor x 5 / Diffusore ellittico (5 unità)	71-5167-00-00
Quadratischer Diffusor x 5 / Diffusore quadrato (5 unità)	71-5658-00-00
Weichzeichnerlinse x 5 / Sagomatore di fascio (5 unità)	71-6099-00-00
Schirm x 5 / Screen x 5	71-7895-60-00

Smart Compatible-Zub. / Access. Smart Compatibile	
71-5959-00-00	Dimmer Phase Cut Casambi (TS)
71-5961-00-00	Dimmer DALI Casambi (DS) (TW)
71-A260-00-00	Driver Casambi 350-1050mA 38W (BB)

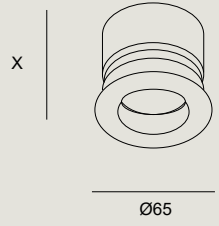
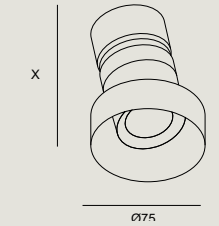

Model	W	K/ CRI/ Real lm	Optics	Source	Finishes
AG15 - Rund / Fest Rotondo / Fisso Ⓢ 58 IP54 	P7 6,4W	V9 2700K/CRI90 524 lm	S2 14°	OU ON-OFF/100-240V 50-60Hz	14 60
		W9 3000K/CRI90 629 lm	M2 27°	TS PHASE CUT 220-240V/50-60Hz	
		X9 4000K/CRI90 646 lm	F1 49°	DS DALI-2/220-240V 50-60Hz	
			BB 9V/Max. 700mA		
			M2 27°	O1 Emergency ON-OFF 1H /220-240V/50-60Hz	
			O3 Emergency ON-OFF 3H/220-240V 50-60Hz		
			D1 Emergency DALI 1H 220-240V/50-60Hz		
			D3 Emergency DALI 3H 220-240V/50-60Hz		
AG17 - Rund schwenkbar randlos Rotondo regolabile senza cornice Ⓢ 75 IP23 ↕±20° ↻360° 	13 11,9W	V9 2700K/CRI90 1106 lm	S2 19°	OU ON-OFF/100-240V 50-60Hz	
		W9 3000K/CRI90 1195 lm	M2 33°	TS PHASE CUT/220-240V 50-60Hz	
		X9 4000K/CRI90 1336 lm	F1 44°	DS DALI-2/220-240V/ 50-60Hz	
				BB 36V/Max. 350mA	
				M2 33°	O1 Emergency ON-OFF 1H/220-240V/50-60Hz
				O3 Emergency ON-OFF 3H/220-240V/50-60Hz	
				D1 Emergency DALI 1H 220-240V/50-60Hz	
				D3 Emergency DALI 3H 220-240V/50-60Hz	
	18 17.7W	V9 2700K/CRI90 1313 lm	S2 19°	OU ON-OFF 100-240V/ 50-60Hz	
		W9 3000K/CRI90 1628 lm	M2 33°	TS PHASE CUT 220-240V/ 50-60Hz	
		X9 4000K/CRI90 1722 lm	F1 47°	DS DALI-2 220-240V/50-60Hz	
				BB 36V/Max. 500mA	
	13 11.9W	S9 Warm Dimming 1800K - 3000K CRI 95/892 lm	S2 18°	TS PHASE-CUT 220-240V/50-60Hz	
U9 TW 2700K-6500K CRI90/978 lm		M2 33°	TW DALI DT8/220-240V 50-60Hz		
12 12.5W		F1 44°			
AA GU10	G1	NA	BU 220-240V/50-60Hz		

P. 940

nicht inklusive / Non incluso

Visueller Komfort Weiß / Comfort visivo bianco	71-4754-14-00
Visueller Komfort Schwarz / Comfort visivo nero	71-4754-60-00
Wabenraster x 5 / Pannello a nido d'ape (5 unità)	71-5166-60-00
Elliptischer Diffusor x 5 / Diffusore ellittico (5 unità)	71-5167-00-00
Quadratischer Diffusor x 5 / Diffusore quadrato (5 unità)	71-5658-00-00
Weichzeichnerlinse x 5 / Sagomatore di fascio (5 unità)	71-6099-00-00
Schirm x 5 / Screen x 5	71-7895-60-00

Smart Compatible-Zub. / Access. Smart Compatibile







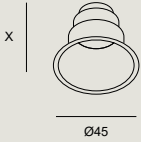

71-5959-00-00	Dimmer Phase Cut Casambi (TS)
71-5961-00-00	Dimmer DALI Casambi (DS) (TW)
71-A260-00-00	Driver Casambi 350-1050mA 38W (BB)

PLAY

High Visual Comfort Mini

BODY MAT	DIF MAT	IP	50000h	WELL
AL	PMMA	54	L80 B20	











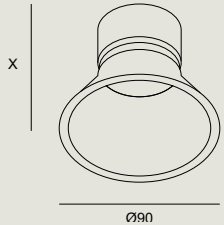











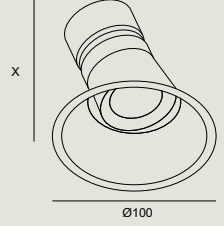



Codebeispiel / Esempio di codice: AG36-P2V8S10U14

Model	W	K/ CRI/ Real lm	Optics	Source	Finishes						
 <p>AG36 - Rund / Fest Rotondo / Fisso Ⓜ 40 IP54</p> <table border="1"> <tr> <th>W</th> <th>X</th> </tr> <tr> <td>1,5 W</td> <td>60</td> </tr> <tr> <td>3 W</td> <td>50</td> </tr> </table> 	W	X	1,5 W	60	3 W	50	P2 1,5W	V8 2700K/CRI80 116 lm	S1 8°	OU  ON-OFF 100-277V 50-60Hz	14  60 
	W	X									
	1,5 W	60									
	3 W	50									
	W8 3000K/CRI80 110 lm	BB  3V/Max. 500mA									
	X8 4000K/CRI80 110 lm										
P3 3,2W	V8 2700K/CRI8/ 350 lm	M2 28°	OU  ON-OFF 100-277V 50-60Hz								
	W8 3000K/CRI80 299 lm	F1 47°	BB  9V Max.350mA								
	X8 4000K/CRI80 337 lm	F1 29°									
 <p>AG41 - Rund fest randlos Rotondo fisso senza cornice Ⓜ 36 IP54</p> <table border="1"> <tr> <th>W</th> <th>X</th> </tr> <tr> <td>1,5 W</td> <td>50</td> </tr> <tr> <td>3 W</td> <td>40</td> </tr> </table> 	W	X	1,5 W	50	3 W	40					
	W	X									
	1,5 W	50									
3 W	40										

 P. 940

nicht inklusive / Non incluso

Beton-Unterputzset Ø36 Kit incasso in cemento Ø36	71-5617-60-00
Beton-Unterputzset Ø40-42 Kit incasso in cemento Ø40-42	71-5618-60-00
Elliptischer Diffusor x 5 Diffusore ellittico x 5	71-7891-00-00
Wabenraster x 5 Pannello a nido d'ape x 5	71-7892-60-00
Weichzeichnerlinse x 5 Sagomatore di fascio x 5	71-7893-00-00
Visueller Komfort Schwarz Comfort visivo nero	71-7524-60-00
Schirm x 5 Screen x 5	71-7894-60-00

Model	W	K/ CRI/ Real lm	Optics	Source	Finishes												
 <p>AG13 - Rund / Fest Rotondo / Fisso ① 78 IP54</p> <table border="1"> <thead> <tr> <th>W</th> <th>X</th> </tr> </thead> <tbody> <tr> <td>7 W</td> <td>105</td> </tr> <tr> <td>13 W</td> <td>125</td> </tr> <tr> <td>18 W</td> <td>145</td> </tr> <tr> <td>Warm-dim</td> <td>140</td> </tr> <tr> <td>GU10 MR16*</td> <td>115</td> </tr> </tbody> </table> 	W	X	7 W	105	13 W	125	18 W	145	Warm-dim	140	GU10 MR16*	115	P7 6,4W	V9 2700K/CRI90 524 lm	S2 14°	OU  ON-OFF/100-240V 50-60Hz	14  60 
	W	X															
	7 W	105															
	13 W	125															
	18 W	145															
	Warm-dim	140															
	GU10 MR16*	115															
	W9 3000K/CRI90 606 lm	M2 28°	TS  PHASE CUT/ 220-240V/50-60Hz														
	X9 4000K/CRI90 618 lm	F1 48°	DS  DALI-2/220-240V 50-60Hz														
		BB  9V/Max. 700mA															
	M2 28°	O1  Emergency ON-OFF 1H/220-240V/ 50-60Hz															
	O3  Emergency ON-OFF 3H/220-240V/ 50-60Hz																
	D1  Emergency DALI 1H 220-240V/50-60Hz																
	D3  Emergency DALI 3H 220-240V/ 50-60Hz																
 <p>AG14 - Rund / Schwenkbar Rotondo / Regolabile ① 95 IP23</p> <table border="1"> <thead> <tr> <th>W</th> <th>X</th> </tr> </thead> <tbody> <tr> <td>7 W</td> <td>100</td> </tr> <tr> <td>13 W</td> <td>120</td> </tr> <tr> <td>18 W</td> <td>140</td> </tr> <tr> <td>Warm-dim</td> <td>135</td> </tr> <tr> <td>GU10 MR16*</td> <td>110</td> </tr> </tbody> </table> 	W	X	7 W	100	13 W	120	18 W	140	Warm-dim	135	GU10 MR16*	110	13 11,9W	V9 2700K/CRI90 1096 lm	S2 19°	OU  ON-OFF/100-240V/ 50-60Hz	
	W	X															
	7 W	100															
	13 W	120															
	18 W	140															
	Warm-dim	135															
	GU10 MR16*	110															
	W9 3000K/CRI90 1216 lm	M2 34°	TS  PHASE CUT 220-240V/50-60Hz														
	X9 4000K/CRI90 1326 lm	F1 44°	DS  DALI-2/220-240V 50-60Hz														
		BB  36V/Max. 350mA															
	M2 34°	O1  Emergency ON-OFF 1H/220-240V/ 50-60Hz															
	O3  Emergency ON-OFF 3H/220-240V/ 50-60Hz																
	D1  Emergency DALI 1H /220-240V/50-60Hz																
	D3  Emergency DALI 3H 220-240V/ 50-60Hz																
18 17.7W	V9 2700K/CRI90 1391 lm	S2 20°	OU  ON-OFF/100-240V 50-60Hz														
	W9 3000K/CRI90 1617 lm	M2 33°	TS  PHASE CUT 220-240V/50-60Hz														
	X9 4000K/CRI90 1714 lm	F1 47°	DS  DALI-2/220-240V 50-60Hz														
13 11.9W	S9 Warm Dimming 1800K - 3000K /CRI 95/883 lm	S2 19°	TS  PHASE CUT 220-240V/50-60Hz														
		M2 34°															
12 12.5W	U9 TW 2700K-6500K CRI90/1014 lm	F1 44°	TW  DALI DT8 220-240V/50-60Hz														
AA GU10	G1	NA	BU 220-240V/50-60Hz														

 P.940**nicht inklusive / Non incluso**

Visueller Komfort Weiß / Comfort visivo bianco	71-4754-14-00
Visueller Komfort Schwarz / Comfort visivo nero	71-4754-60-00
Wabenraster x 5 / Pannello a nido d'ape (5 unità)	71-5166-60-00
Elliptischer Diffusor x 5 / Diffusore ellittico (5 unità)	71-5167-00-00
Quadratischer Diffusor x 5 / Diffusore quadrato (5 unità)	71-5658-00-00
Weichzeichnerlinse x 5 / Sagomatore di fascio (5 unità)	71-6099-00-00
Schirm x 5 / Screen x 5	71-7895-60-00

Smart Compatible-Zub. / Access. Smart Compatibile







71-5959-00-00	Dimmer Phase Cut Casambi (TS)
71-5961-00-00	Dimmer DALI Casambi (DS) (TW)
71-A260-00-00	Driver Casambi 350-1050mA 38W (BB)

PLAY

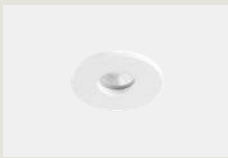
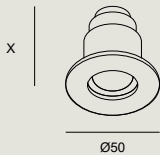
IP65 Mini

BODY MAT	IP	50000h		WELL
AL	65	L80 B20		

Codebeispiel / Esempio di codice: AG37-P2V8S10U14











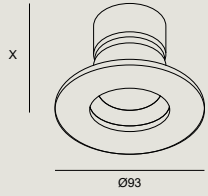















Model	W	K/ CRI/ Real lm	Optics	Source	Finishes						
 <p>AG37 - Rund / Fest Rotondo / Fisso ④ 40 IP65</p> <table border="1"> <tr> <th>W</th> <th>X</th> </tr> <tr> <td>1,5 W</td> <td>45</td> </tr> <tr> <td>3 W</td> <td>35</td> </tr> </table> 	W	X	1,5 W	45	3 W	35	P2 1,5W	V8 2700K/CRI80 /112 lm	S1 8°	OU  ON-OFF/ 100-277V/ 50-60Hz	14  60 
	W	X									
	1,5 W	45									
	3 W	35									
		W8 3000K/CRI80 /108 lm		BB  3V/Max.500mA							
		X8 4000K/CRI80 /108 lm									
P3 3,2W	V8 2700K/CRI80 /316 lm	M2 28°	OU  ON-OFF/ 100-277V/ 50-60Hz								
	W8 3000K/CRI80 /278 lm	F1 47°	BB  9V/Max.350mA								
	X8 4000K/CRI80 /306 lm	F1 28°									

 P. 940

nicht inklusive / Non incluso

Wabenraster x 5 Pannello a nido d'ape x 5	71-7892-60-00
Weichzeichnerlinse x 5 Sagomatore di fascio x 5	71-7893-00-00
Beton-Unterputzset 40-42 Kit incasso in cemento 40-42	71-5618-60-00
Visueller Komfort Schwarz Comfort visivo nero	71-7524-60-00
Schirm x 5 Screen x 5	71-7894-60-00
Beton-Unterputzset Ø40-42 Kit incasso in cemento Ø40-42	71-5618-60-00



Model	W	K/ CRI/ Real lm	Optics	Source	Finishes												
 <p>AG16 - Rund / Fest Rotondo / Fisso Ø 65 IP65</p> <table border="1"> <thead> <tr> <th>W</th> <th>X</th> </tr> </thead> <tbody> <tr><td>7 W</td><td>80</td></tr> <tr><td>13 W</td><td>100</td></tr> <tr><td>18 W</td><td>120</td></tr> <tr><td>Warm-dim</td><td>115</td></tr> <tr><td>GU10 MR16*</td><td>90</td></tr> </tbody> </table> 	W	X	7 W	80	13 W	100	18 W	120	Warm-dim	115	GU10 MR16*	90	P7 6,4W	V9 2700K/CRI90 504 lm	S2 15°	OU  ON-OFF 100-240V /50-60Hz	14  60  ONLY FOR AG16 21 
	W	X															
	7 W	80															
	13 W	100															
	18 W	120															
	Warm-dim	115															
	GU10 MR16*	90															
	W9 3000K/CRI90 595 lm	M2 28°	TS  PHASE CUT 220-240V/50-60Hz														
	X9 4000K/CRI90 618 lm	F1 48°	DS  DALI-2 220-240V/50-60Hz														
		BB  9V/Max. 700mA															
		M2 28°	O1  Emergency ON-OFF 1H 220-240V/50-60Hz														
		O3  Emergency ON-OFF 3H 220-240V/50-60Hz															
	D1  Emergency DALI 1H/220-240V 50-60Hz																
	D3  Emergency DALI 3H/220-240V 50-60Hz																
	S2 22°	OU  ON-OFF 100-240V /50-60Hz															
	M2 34°	TS  PHASE CUT 220-240V/50-60Hz															
	F1 44°	DS  DALI-2 220-240V/50-60Hz															
	BB  36V/Max. 350mA																
	M2 34°	O1  Emergency ON-OFF 1H 220-240V/50-60Hz															
	O3  Emergency ON-OFF 3H 220-240V/50-60Hz																
	D1  Emergency DALI 1H/220-240V 50-60Hz																
	D3  Emergency DALI 3H/220-240V 50-60Hz																
	S2 21°	OU  ON-OFF/100-240V 50-60Hz															
	M2 34°	TS  PHASE CUT 220-240V/50-60Hz															
	F1 51°	DS  DALI-2 220-240V/50-60Hz															
	BB  36V/Max. 500mA																
	S2 19°	TS  PHASE CUT 220-240V/50-60Hz															
	M2 34°																
	F1 44°	TW  DALI DT8 220-240V/50-60Hz															
	NA	BU 220-240V/50-60Hz															
AA GU10	G1																

nicht inklusive / Non incluso

Visueller Komfort Weiß / Comfort visivo bianco	71-4754-14-00
Visueller Komfort Schwarz / Comfort visivo nero	71-4754-60-00
Wabenraster x 5 / Pannello a nido d'ape (5 unità)	71-5166-60-00
Elliptischer Diffusor x 5 / Diffusore ellittico (5 unità)	71-5167-00-00
Quadratischer Diffusor x 5 / Diffusore quadrato (5 unità)	71-5658-00-00
Weichzeichnerlinse x 5 / Sagomatore di fascio (5 unità)	71-6099-00-00
Schirm x 5 / Screen x 5	71-7895-60-00

Smart Compatible-Zub. / Access. Smart Compatibile











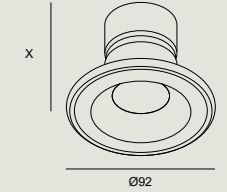







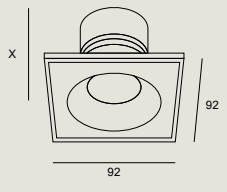



71-5959-00-00	Dimmer Phase Cut Casambi (TS)
71-5961-00-00	Dimmer DALI Casambi (DS) (TW)
71-A260-00-00	Driver Casambi 350-1050mA 38W (BB)

PLAY

IP65 Glass

DIF MAT	IP	WELL	(SC)
GLA	65		

Codebeispiel / Esempio di codice: AG43-P7V9S2OU14

Model	W	K/ CRI/ Real lm	Optics	Source	Finishes													
 <p>AG43 - Rund / Fest Rotondo / Fisso Ⓜ 68 IP65</p> <table border="1"> <tr> <th>W</th> <th>X</th> </tr> <tr> <td>7 W</td> <td>80</td> </tr> <tr> <td>13 W</td> <td>100</td> </tr> </table> 	W	X	7 W	80	13 W	100	P7 6,4W	V9 2700K/CRI90 483 lm	S2 14°	OU  ON-OFF 100-240V/50-60Hz	14 							
	W	X																
	7 W	80																
	13 W	100																
	W9 3000K/CRI90 595 lm	M2 28°	TS  PHASE CUT 220-240V/50-60Hz															
	X9 4000K/CRI90 596 lm	F1 49°	DS  DALI-2 220-240V/50-60Hz															
		BB  9V/Max. 700mA																
		M2 28°	O1  Emergency ON-OFF 1H/220-240V 50-60Hz															
		O3  Emergency ON-OFF 3H 220-240V/50-60Hz																
	 <p>AG44 - Quadratisch / Fest Quadrato / Fisso Ⓜ 65x65 IP65</p> <table border="1"> <tr> <th>W</th> <th>X</th> </tr> <tr> <td>7 W</td> <td>80</td> </tr> <tr> <td>13 W</td> <td>100</td> </tr> <tr> <td>18 W</td> <td>120</td> </tr> <tr> <td>Warm-dim</td> <td>115</td> </tr> <tr> <td>GU10 MR16*</td> <td>90</td> </tr> </table> 	W	X	7 W	80	13 W	100	18 W	120	Warm-dim		115	GU10 MR16*	90	13 11,9W	V9 2700K/CRI90 926 lm	S2 21°	OU  ON-OFF 100-240V/50-60Hz
		W	X															
		7 W	80															
13 W		100																
18 W		120																
Warm-dim		115																
GU10 MR16*		90																
W9 3000K/CRI90 1176 lm		M2 34°	TS  PHASE CUT 220-240V/50-60Hz															
X9 4000K/CRI90 1260 lm		F1 44°	DS  DALI-2/220-240V 50-60Hz															
		BB  36V/Max. 350mA																
		M2 34°	O1  Emergency ON-OFF 1H 220-240V/ 50-60Hz															
		O3  Emergency ON-OFF 3H 220-240V/50-60Hz																
18 17.7W	V9 2700K/CRI90 1411 lm	S2 19°	OU  ON-OFF/100-240V 50-60Hz															
	W9 3000K/CRI90 1621 lm	M2 34°	TS  PHASE CUT 220-240V/50-60Hz															
	X9 4000K/CRI90 1615 lm	F1 46°	DS  DALI-2/220-240V 50-60Hz															
		BB  36V/Max. 500mA																
	13 11.9W	S9 Warm Dimming 1800K - 3000K CRI 95/747 lm	S2 21°	TS  PHASE CUT 220-240V/50-60Hz														
			M2 34°															
12 12.5W	U9 TW 2700K-6500K CRI90/964 lm	F1 44°	TW  DALI DT8 220-240V/ 50-60Hz															
AA GU10	G1	NA	BU  100-240V 50-60Hz															

 P. 940

nicht inklusive / Non incluso

Visueller Komfort Weiß / Comfort visivo bianco	71-4754-14-00
Visueller Komfort Schwarz / Comfort visivo nero	71-4754-60-00
Wabenraaster x 5 / Pannello a nido d'ape (5 unità)	71-5166-60-00
Elliptischer Diffusor x 5 / Diffusore ellittico (5 unità)	71-5167-00-00
Quadratischer Diffusor x 5 / Diffusore quadrato (5 unità)	71-5658-00-00
Weichzeichnerlinse x 5 / Sagomatore di fascio (5 unità)	71-6099-00-00
Schirm x 5 / Screen x 5	71-7895-60-00

Smart Compatible-Zub. / Access. Smart Compatibile

71-5959-00-00	Dimmer Phase Cut Casambi (TS)
71-5961-00-00	Dimmer DALI Casambi (DS) (TW)
71-A260-00-00	Driver Casambi 350-1050mA 38W (BB)

PLAY

Pinhole Mini



BODY MAT
AL

50000h
L80 B20

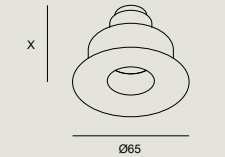

WELL

Codebeispiel / Esempio di codice: AG61-P2V8S10U14

Model	W	K/ CRI/ Real lm	Optics	Source	Finishes						
 <p>AG61 - Rund / Fest Rotondo / Fisso Ⓜ 55 IP54</p> <table border="1"> <tr> <th>W</th> <th>X</th> </tr> <tr> <td>1,5 W</td> <td>60</td> </tr> <tr> <td>3 W</td> <td>50</td> </tr> </table> 	W	X	1,5 W	60	3 W	50	P2 1,5W	V8 2700K/CRI80 85 lm	S1 9°	OU ON-OFF 100-277V /50-60Hz BB 3V Max. 500mA	14 60
	W	X									
	1,5 W	60									
	3 W	50									
	W8 3000K/CRI80 84 lm										
	X8 4000K/CRI80 84 lm										
P3 3.2W	V8 2700K/CRI80 300 lm	M2 28° F1 45°	OU ON-OFF 100-277V /50-60Hz BB 9V Max. 350mA								
	W8 3000K/CRI80 268 lm										
	X8 4000K/CRI80 268 lm										
 <p>AG62 - Rund / Schwenkbar Rotondo / Regolabile Ⓜ 55 IP23</p> <table border="1"> <tr> <th>W</th> <th>X</th> </tr> <tr> <td>1,5 W</td> <td>60</td> </tr> <tr> <td>3 W</td> <td>50</td> </tr> </table> 	W	X	1,5 W	60	3 W	50					
	W	X									
	1,5 W	60									
	3 W	50									

P.940

nicht inklusive / Non incluso





Wabenraster x 5 Pannello a nido d'ape x 5	71-7892-60-00
Weichzeichnerlinse x 5 Sagomatore di fascio x 5	71-7893-00-00
Beton-Unterputzset 40-42 Kit incasso in cemento 40-42	71-5618-60-00
Visueller Komfort Schwarz Comfort visivo nero	71-7524-60-00
Schirm x 5 Screen x 5	71-7894-60-00

PLAY

Pinhole



Codebeispiel / Esempio di codice: AG45-P7V9S2OU14

Model	W	K/ CRI/ Real lm	Optics	Source	Finishes												
 <p>AG45 - Rund / Fest Rotondo / Fisso Ⓢ 75 IP54</p> <table border="1"> <thead> <tr> <th>W</th> <th>X</th> </tr> </thead> <tbody> <tr> <td>7 W</td> <td>90</td> </tr> <tr> <td>13 W</td> <td>110</td> </tr> <tr> <td>18 W</td> <td>130</td> </tr> <tr> <td>Warm-dim</td> <td>125</td> </tr> <tr> <td>GU10 MR16*</td> <td>100</td> </tr> </tbody> </table> <p>Ø88</p>	W	X	7 W	90	13 W	110	18 W	130	Warm-dim	125	GU10 MR16*	100	P7 6,4W	V9 2700K/CRI90 279 lm	S2 14°	OU ON-OFF 100-240V/ 50-60Hz	14
	W	X															
	7 W	90															
13 W	110																
18 W	130																
Warm-dim	125																
GU10 MR16*	100																
W9 3000K/CRI90 354 lm	M2 32°	TS PHASE CUT 220-240V/50-60Hz															
X9 4000K/CRI90 354 lm	F1 46°	DS DALI-2 220-240V/ 50-60Hz BB 9V/Max. 700mA															
 <p>AG46 - Quadratisch / Fest Quadrato / Fisso Ⓢ 75x55 IP54</p> <table border="1"> <thead> <tr> <th>W</th> <th>X</th> </tr> </thead> <tbody> <tr> <td>7 W</td> <td>90</td> </tr> <tr> <td>13 W</td> <td>110</td> </tr> <tr> <td>18 W</td> <td>130</td> </tr> <tr> <td>Warm-dim</td> <td>125</td> </tr> <tr> <td>GU10 MR16*</td> <td>100</td> </tr> </tbody> </table> <p>85</p>	W	X	7 W	90	13 W	110	18 W	130	Warm-dim	125	GU10 MR16*	100	13 11,9W	V9 2700K/CRI90 958 lm	S2 18°	OU ON-OFF 100-240V/ 50-60Hz	
	W	X															
	7 W	90															
13 W	110																
18 W	130																
Warm-dim	125																
GU10 MR16*	100																
W9 3000K/CRI90 1160 lm	M2 33°	TS PHASE CUT 220-240V/50-60Hz															
X9 4000K/CRI90 1244 lm	F1 45°	DS DALI-2 220-240V/ 50-60Hz BB 36V/Max. 350mA															
 <p>AG47 - Rund / Schwenkbar Rotondo / Regolabile Ⓢ 75 IP23</p> <table border="1"> <thead> <tr> <th>W</th> <th>X</th> </tr> </thead> <tbody> <tr> <td>7 W</td> <td>90</td> </tr> <tr> <td>13 W</td> <td>110</td> </tr> <tr> <td>18 W</td> <td>130</td> </tr> <tr> <td>Warm-dim</td> <td>125</td> </tr> <tr> <td>GU10 MR16*</td> <td>100</td> </tr> </tbody> </table> <p>Ø88</p>	W	X	7 W	90	13 W	110	18 W	130	Warm-dim	125	GU10 MR16*	100	18 17.7W	V9 2700K/CRI90 1162 lm	S2 18°	OU ON-OFF/100-240V 50-60Hz	
	W	X															
	7 W	90															
13 W	110																
18 W	130																
Warm-dim	125																
GU10 MR16*	100																
W9 3000K/CRI90 1221 lm	M2 29°	TS PHASE CUT 220-240V/50-60Hz															
X9 4000K/CRI90 1551 lm	F1 46°	DS DALI-2 220-240V/ 50-60Hz BB 36V/Max. 500mA															
 <p>AG48 - Quadratisch / Schwenkbar Quadrato / Regolabile Ⓢ 75x55 IP23</p> <table border="1"> <thead> <tr> <th>W</th> <th>X</th> </tr> </thead> <tbody> <tr> <td>7 W</td> <td>90</td> </tr> <tr> <td>13 W</td> <td>110</td> </tr> <tr> <td>18 W</td> <td>130</td> </tr> <tr> <td>Warm-dim</td> <td>125</td> </tr> <tr> <td>GU10 MR16*</td> <td>100</td> </tr> </tbody> </table> <p>85</p>	W	X	7 W	90	13 W	110	18 W	130	Warm-dim	125	GU10 MR16*	100	13 11.9W	S9 Warm Dimming 1800K - 3000K CRI 95/899 lm	S2 18°	TS PHASE CUT 220-240V/50-60Hz	
	W	X															
	7 W	90															
13 W	110																
18 W	130																
Warm-dim	125																
GU10 MR16*	100																
U9 TW 2700K-6500K CRI90/941 lm	M2 32°	TW DALI DT8 220-240V/ 50-60Hz															
AA GU10	G1	NA BU 100-240V 50-60Hz															

P.940

nicht inklusive / Non incluso

Visueller Komfort Weiß / Comfort visivo bianco	71-4754-14-00
Visueller Komfort Schwarz / Comfort visivo nero	71-4754-60-00
Wabenraster x 5 / Pannello a nido d'ape (5 unità)	71-5166-60-00
Elliptischer Diffusor x 5 / Diffusore ellittico (5 unità)	71-5167-00-00
Quadratischer Diffusor x 5 / Diffusore quadrato (5 unità)	71-5658-00-00
Weichzeichnerlinse x 5 / Sagomatore di fascio (5 unità)	71-6099-00-00
Schirm x 5 / Screen x 5	71-7895-60-00

Smart Compatible-Zub. / Access. Smart Compatibile







71-5959-00-00	Dimmer Phase Cut Casambi (TS)
71-5961-00-00	Dimmer DALI Casambi (DS) (TW)
71-A260-00-00	Driver Casambi 350-1050mA 38W (BB)

PLAY

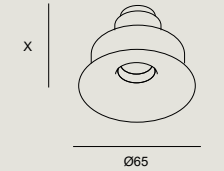
Soft Mini

BODY MAT	50000h		WELL
AL	L80 B20		

Codebeispiel / Esempio di codice: AG63-P2V8S1OU14

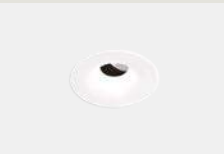
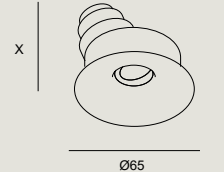
Model	W	K/ CRI/ Real lm	Optics	Source	Finishes						
 <p>AG63 - Rund / Fest Rotondo / Fisso ① 55 IP54</p> <table border="1"> <tr> <th>W</th> <th>X</th> </tr> <tr> <td>1,5 W</td> <td>60</td> </tr> <tr> <td>3 W</td> <td>50</td> </tr> </table> 	W	X	1,5 W	60	3 W	50	P2 1,5W	V8 2700K CRI80/89 lm	S1 7°	OU  ON-OFF 100-277V/50-60Hz	14  60 
	W	X									
	1,5 W	60									
	3 W	50									
	W8 3000K CRI80/87 lm	BB  3V Max. 500mA									
	X8 4000K CRI80/87 lm										
P3 3.2W	V8 2700K CRI80/300 lm	M2 28°	OU  ON-OFF 100-277V/50-60Hz								
	W8 3000K CRI80/274 lm	F1 45°	BB  9V Max. 350mA								
	X8 4000K CRI80/274 lm										
 <p>AG64 - Rund / Schwenkbar Rotondo / Regolabile ① 55 IP23</p> <table border="1"> <tr> <th>W</th> <th>X</th> </tr> <tr> <td>1,5 W</td> <td>60</td> </tr> <tr> <td>3 W</td> <td>50</td> </tr> </table> 	W	X	1,5 W	60	3 W	50					
	W	X									
	1,5 W	60									
3 W	50										

 P.940

nicht inklusive / Non incluso





Wabenraster x 5 Pannello a nido d'ape x 5	71-7892-60-00
Weichzeichnerlinse x 5 Sagomatore di fascio x 5	71-7893-00-00
Beton-Unterputzset 40-42 Kit incasso in cemento 40-42	71-5618-60-00
Visueller Komfort Schwarz Comfort visivo nero	71-7524-60-00
Schirm x 5 Screen x 5	71-7894-60-00

PLAY

Soft

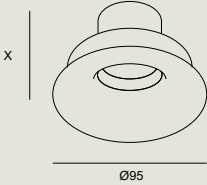

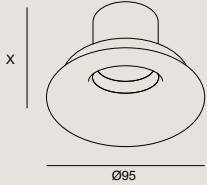
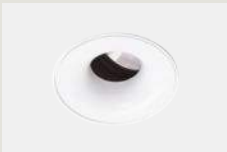
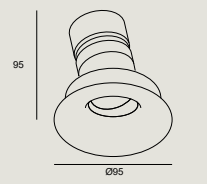
Codebeispiel / Esempio di codice: AG49-P7V9S2OU14

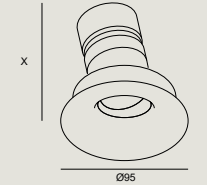
Model	W	K/ CRI/ Real lm	Optics	Source	Finishes
AG49 - Rund / Fest Rotondo / Fisso Ⓢ 86 IP54  	P7 6,4W	V9 2700K/CRI90 311 lm	S2 14°	OU ON-OFF 100-240V/ 50-60Hz	14 60
		W9 3000K/CRI90 386 lm	M2 33°	TS PHASE CUT 220-240V/50-60Hz	
		X9 4000K/CRI90 386 lm	F1 49°	DS DALI-2 220-240V/ 50-60Hz BB 9V/Max. 700mA	
		M2 33°	O1 Emergency ON-OFF 1H 220-240V/50-60Hz O3 Emergency ON-OFF 3H/220-240V/50- 60Hz D1 Emergency DALI 1H 220-240V/50-60Hz D3 Emergency DALI 3H 220-240V/50-60Hz		
	AG51 - Rund fest randlos Rotondo fisso senza cornice Ⓢ 102 IP54  	13 11,9W	V9 2700K/CRI90 1040 lm	S2 18°	OU ON-OFF 100-240V/ 50-60Hz
			W9 3000K/CRI90 1237 lm	M2 34°	TS PHASE CUT 220-240V/50-60Hz
			X9 4000K/CRI90 1338 lm	F1 46°	DS DALI-2220-240V/ 50-60Hz BB 36V/Max. 350mA
			M2 34°	O1 Emergency ON-OFF 1H/220- 240V/50-60Hz O3 Emergency ON-OFF 3H 220-240V/50-60Hz D1 Emergency DALI 1H 220-240V/50-60Hz D3 Emergency DALI 3H 220-240V/50-60Hz	
AG52 - Rund / Schwenkbar Rotondo / Regolabile Ⓢ 86 IP23  	18 17.7W	V9 2700K/CRI90 1615 lm	S2 22°	OU ON-OFF 100-240V/ 50-60Hz	
		W9 3000K/CRI90 1610 lm	M2 33°	TS PHASE CUT 220-240V/50-60Hz	
		X9 4000K/CRI90 1477 lm	F1 51°	DS DALI-2 220-240V/ 50-60Hz BB 36V/Max. 500mA	
AG53 - Rund schwenkbar randlos Rotondo regolabile senza cornice Ⓢ 102 IP23  	13 11.9W	S9 Warm Dimming 1800K - 3000K CRI95/1004 lm	S2 19° M2 34°	TS PHASE CUT 220-240V/50-60Hz	
	12 12.5W	U9 TW 2700K-6500K CRI90/1036 lm	F1 45°	TW DALI DT8 220-240V/ 50-60Hz	
	AA GU10	G1	NA	BU 100-240V 50-60Hz	

P. 940

nicht inklusive / Non incluso



Visueller Komfort Weiß / Comfort visivo bianco	71-4754-14-00
Visueller Komfort Schwarz / Comfort visivo nero	71-4754-60-00
Wabenraster x 5 / Pannello a nido d'ape (5 unità)	71-5166-60-00
Elliptischer Diffusor x 5 / Diffusore ellittico (5 unità)	71-5167-00-00
Quadratischer Diffusor x 5 / Diffusore quadrato (5 unità)	71-5658-00-00
Weichzeichnerlinse x 5 / Sagomatore di fascio (5 unità)	71-6099-00-00
Schirm x 5 / Screen x 5	71-7895-60-00

Smart Compatible-Zub. / Access. Smart Compatibile

71-5959-00-00	Dimmer Phase Cut Casambi (TS)
71-5961-00-00	Dimmer DALI Casambi (DS) (TW)
71-A260-00-00	Driver Casambi 350-1050mA 38W (BB)

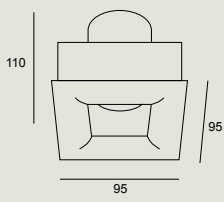

Codebeispiel / Esempio di codice: AG49-P7V9S2OU14

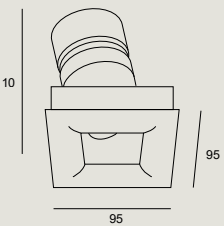
Model	W	K/ CRI/ Real lm	Optics	Source	Finishes
AG54 - Quadratisch / Fest Quadrato / Fisso 85x85 IP54  	P7 6,4W	V9 2700K/CRI90 311 lm	S2 14°	OU ON-OFF/100-240V 50-60Hz	14 60
		W9 3000K/CRI90 386 lm	M2 33°	TS PHASE CUT 220-240V/50-60Hz	
		X9 4000K/CRI90 386 lm	F1 49°	DS DALI-2/220-240V 50-60Hz	
			BB 9V/Max. 700mA		
			M2 33°	O1 Emergency ON-OFF 1H 220-240V/50-60Hz	
			O3 Emergency ON-OFF 3H 220-240V/50-60Hz		
			D1 Emergency DALI 1H 220-240V/50-60Hz		
			D3 Emergency DALI 3H 220-240V/50-60Hz		
AG55 - Quadratisch / Schwenkbar Quadrato / Regolabile 80x80 IP23  	13 11,9W	V9 2700K/CRI90 1040 lm	S2 18°	OU ON-OFF/100-240V 50-60Hz	
		W9 3000K/CRI90 1237 lm	M2 34°	TS PHASE CUT 220-240V/50-60Hz	
		X9 4000K/CRI90 1338 lm	F1 46°	DS DALI-2 220-240V/ 50-60Hz	
			BB 36V/Max. 350mA		
			M2 34°	O1 Emergency ON-OFF 1H 220-240V/50-60Hz	
			O3 Emergency ON-OFF 3H 220-240V/50-60Hz		
	18 17.7W	V9 2700K/CRI90 1615 lm	S2 22°	OU ON-OFF 100-240V/ 50-60Hz	
		W9 3000K/CRI90 1610 lm	M2 33°	TS PHASE CUT 220-240V/50-60Hz	
		X9 4000K/CRI90 1477 lm	F1 51°	DS DALI-2 220-240V/ 50-60Hz	
			BB 36V/Max. 500mA		
	13 11.9W	S9 Warm Dimming 1800K - 3000K CRI 95/1004 lm	S2 19°	TS PHASE CUT 220-240V/50-60Hz	
			M2 34°		
	12 12.5W	U9 TW 2700K-6500K CRI90/1036 lm	F1 45°	TW DALI DT8 220-240V/ 50-60Hz	
	AA GU10	G1	NA	BU 100-240V/50-60Hz	

P. 940

nicht inklusive / Non incluso

Visueller Komfort Weiß / Comfort visivo bianco	71-4754-14-00
Visueller Komfort Schwarz / Comfort visivo nero	71-4754-60-00
Wabenraster x 5 / Pannello a nido d'ape (5 unità)	71-5166-60-00
Elliptischer Diffusor x 5 / Diffusore ellittico (5 unità)	71-5167-00-00
Quadratischer Diffusor x 5 / Diffusore quadrato (5 unità)	71-5658-00-00
Weichzeichnerlinse x 5 / Sagomatore di fascio (5 unità)	71-6099-00-00
Schirm x 5 / Screen x 5	71-7895-60-00

Smart Compatible-Zub. / Access. Smart Compatibile

71-5959-00-00	Dimmer Phase Cut Casambi (TS)
71-5961-00-00	Dimmer DALI Casambi (DS) (TW)
71-A260-00-00	Driver Casambi 350-1050mA 38W (BB)

PLAY

Snoot Mini

BODY MAT	IP	50000h				WELL
AL	23	L80 B20	320°	+40°		

Codebeispiel / Esempio di codice: AG65-P2V8S10U14

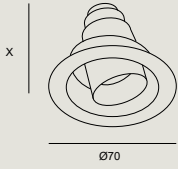
Model	W	K/ CRI/ Real lm	Optics	Source	Finishes						
 <p>AG65 - Rund / Schwenkbar Rotondo / Regolabile Ⓜ 60 IP23</p> <table border="1"> <tr> <td>W</td> <td>X</td> </tr> <tr> <td>1,5 W</td> <td>50</td> </tr> <tr> <td>3 W</td> <td>40</td> </tr> </table> 	W	X	1,5 W	50	3 W	40	P2 1,5W	V8 2700K/CRI80 97 lm	S1 11°	OU ON-OFF 100-277V /50-60Hz	14 60
	W	X									
	1,5 W	50									
	3 W	40									
	W8 3000K/CRI80 95 lm	BB 3V/Max. 500mA									
	X8 4000K/CRI80 95 lm										
	P3 3.2W	V8 2700K/CRI80 310 lm	M2 28°	OU ON-OFF 100-277V /50-60Hz							
		W8 3000K/CRI80 300 lm		F1 46°	BB 9V/Max. 350mA						
		X8 4000K/CRI80 300 lm									

P. 940



nicht inklusive / Non incluso	
Wabenraster x 5 Pannello a nido d'ape x 5	71-7892-60-00
Weichzeichnerlinse x 5 Sagomatore di fascio x 5	71-7893-00-00
Beton-Unterputzset 40-42 Kit incasso in cemento 40-42	71-5618-60-00
Visueller Komfort Schwarz Comfort visivo nero	71-7524-60-00
Schirm x 5 Screen x 5	71-7894-60-00

PLAY

Snoot

BODY MAT	IP				WELL	
AL	23	320°	40°			

Codebeispiel / Esempio di codice: AG56-P7V9S2OU14

Model	W	K/ CRI/ Real lm	Optics	Source	Finishes																								
 <p>AG56 - Rund / Schwenkbar Rotondo / Regolabile ⌀ 85 IP23 ↖ 40° ↷ 320°</p> <table border="1"> <thead> <tr> <th>W</th> <th>X</th> </tr> </thead> <tbody> <tr> <td>7 W</td> <td>80</td> </tr> <tr> <td>13 W</td> <td>100</td> </tr> <tr> <td>18 W</td> <td>120</td> </tr> <tr> <td>Warm-dim</td> <td>115</td> </tr> <tr> <td>GU10 MR16*</td> <td>70</td> </tr> </tbody> </table>  <p>AG57 - Rund schwenkbar randlos Rotondo regolabile senza cornice ⌀ 87 IP23 ↖ 40° ↷ 320°</p> <table border="1"> <thead> <tr> <th>W</th> <th>X</th> </tr> </thead> <tbody> <tr> <td>7 W</td> <td>90</td> </tr> <tr> <td>13 W</td> <td>110</td> </tr> <tr> <td>18 W</td> <td>125</td> </tr> <tr> <td>Warm-dim</td> <td>120</td> </tr> <tr> <td>GU10 MR16*</td> <td>90</td> </tr> </tbody> </table>	W	X	7 W	80	13 W	100	18 W	120	Warm-dim	115	GU10 MR16*	70	W	X	7 W	90	13 W	110	18 W	125	Warm-dim	120	GU10 MR16*	90	P7 6,4W	V9 2700K/CRI90 512 lm W9 3000K/CRI90 590 lm X9 4000K/CRI90 590 lm	S2 14° M2 27° F1 48° M2 27°	OU ON-OFF 100-240V/ 50-60Hz TS PHASE CUT 220-240V/50-60Hz DS DALI-2 220-240V/ 50-60Hz BB 9V/Max. 700mA O1 Emergency ON-OFF 1H/220- 240V/50-60Hz O3 Emergency ON-OFF 3H 220-240V/50-60Hz D1 Emergency DALI 1H 220-240V/50-60Hz D3 Emergency DALI 3H 220-240V/50-60Hz OU ON-OFF 100-240V/50-60Hz TS PHASE CUT 220-240V /50-60Hz DS DALI-2 220-240V/ 50-60Hz BB 36V/Max. 350mA O1 Emergency ON-OFF 1H 220-240V/50-60Hz O3 Emergency ON-OFF 3H 220-240V/50-60Hz D1 Emergency DALI 1H 220-240V/50-60Hz D3 Emergency DALI 3H 220-240V/50-60Hz OU ON-OFF 100-240V/ 50-60Hz TS PHASE CUT 220-240V /50-60Hz DS DALI-2 220-240V/ 50-60Hz BB 36V/Max. 500mA TS PHASE CUT 220-240V /50-60Hz M2 34° F1 44° M2 34° S2 19° M2 33° F1 46° S2 19° M2 34° F1 44° TW DALI DT8 220-240V/ 50-60Hz BU 100-240V/50-60Hz	14 60
	W	X																											
	7 W	80																											
	13 W	100																											
	18 W	120																											
	Warm-dim	115																											
	GU10 MR16*	70																											
	W	X																											
	7 W	90																											
	13 W	110																											
	18 W	125																											
	Warm-dim	120																											
GU10 MR16*	90																												
	13 11,9W	V9 2700K/CRI90 1064 lm W9 3000K/CRI90 1203 lm X9 4000K/CRI90 1350 lm	S2 19° M2 34° F1 44° M2 34°																										
	18 17.7W	V9 2700K/CRI90 1344 lm W9 3000K/CRI90 1546 lm X9 4000K/CRI90 1706 lm	S2 19° M2 33° F1 46°																										
	13 11.9W	S9 Warm Dimming 1800K - 3000K CRI95/951 lm	S2 19° M2 34°																										
	12 12.5W	U9 TW 2700K-6500K CRI90/1023 lm	F1 44°																										
	AA GU10	G1	NA																										

P. 940

nicht inklusive / Non incluso	
Visueller Komfort Weiß / Comfort visivo bianco	71-4754-14-00
Visueller Komfort Schwarz / Comfort visivo nero	71-4754-60-00
Wabenraster x 5 / Pannello a nido d'ape (5 unità)	71-5166-60-00
Elliptischer Diffusor x 5 / Diffusore ellittico (5 unità)	71-5167-00-00
Quadratischer Diffusor x 5 / Diffusore quadrato (5 unità)	71-5658-00-00
Weichzeichnerlinse x 5 / Sagomatore di fascio (5 unità)	71-6099-00-00
Schirm x 5 / Screen x 5	71-7895-60-00







Smart Compatible-Zub. / Access. Smart Compatibile	
71-5959-00-00	Dimmer Phase Cut Casambi (TS)
71-5961-00-00	Dimmer DALI Casambi (DS) (TW)
71-A260-00-00	Driver Casambi 350-1050mA 38W (BB)

PLAY

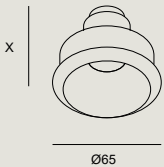
Raw Racy Gold Mini

BODY MAT	IP	50000h		WELL
AL	54	L80 B20		

Codebeispiel / Esempio di codice: AG66-P2V8S10UEP

Model	W	K/ CRI/ Real lm	Optics	Source	Finishes						
 <p>AG66 - Rund / Fest Rotondo / Fisso Ⓜ 55 IP54</p> <table border="1"> <tr> <th>W</th> <th>X</th> </tr> <tr> <td>1,5 W</td> <td>60</td> </tr> <tr> <td>3 W</td> <td>50</td> </tr> </table>  <p>Ø65</p>	W	X	1,5 W	60	3 W	50	P2 1,5W	V8 2700K/CRI80 94 lm	S1 6°	OU  ON-OFF 100-277V /50-60Hz	EP 
	W	X									
	1,5 W	60									
	3 W	50									
	W8 3000K/CRI80 94 lm	BB  3V/Max. 500mA									
	X8 4000K/CRI80 94 lm										
P3 3,2W	V8 2700K/CRI80 319 lm	M2 29°	OU  ON-OFF 100-277V /50-60Hz								
	W8 3000K/CRI80 322 lm		BB  9V/Max. 350mA								
	X8 4000K/CRI80 322 lm		F1 47°								

nicht inklusive / Non incluso







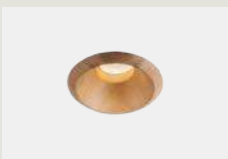
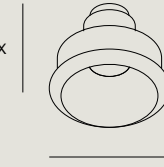

Wabenraster x 5 Pannello a nido d'ape x 5	71-7892-60-00
Weichzeichnerlinse x 5 Sagomatore di fascio x 5	71-7893-00-00
Beton-Unterputzset 40-42 Kit incasso in cemento 40-42	71-5618-60-00
Visueller Komfort Schwarz Comfort visivo nero	71-7524-60-00
Schirm x 5 Screen x 5	71-7894-60-00

PLAY

Raw Mini

IP	50000h		WELL
54	L80 B20		

Codebeispiel / Esempio di codice: AG67-P2V8S10U55

Model	W	K/ CRI/ Real lm	Optics	Source	Finishes						
 <p>AG67 - Rund / Schwenkbar Rotondo / Regolabile Ⓜ 55 IP54</p> <table border="1"> <tr> <th>W</th> <th>X</th> </tr> <tr> <td>1,5 W</td> <td>60</td> </tr> <tr> <td>3 W</td> <td>50</td> </tr> </table>  <p>Ø65</p>	W	X	1,5 W	60	3 W	50	P2 1,5W	V8 2700K/CRI80 79 lm	S1 6°	OU  ON-OFF 100-277V /50-60Hz	55  EN  EO 
	W	X									
	1,5 W	60									
	3 W	50									
	W8 3000K/CRI80 77 lm	BB  3V/Max. 500mA									
	X8 4000K/CRI80 77 lm										
P3 3,2W	V8 2700K/CRI80 268 lm	M2 29°	OU  ON-OFF 100-277V /50-60Hz								
	W8 3000K/CRI80 264 lm		BB  9V/Max. 350mA								
	X8 4000K/CRI80 264 lm		F1 47°								

 P. 940

nicht inklusive / Non incluso

Wabenraster x 5 Pannello a nido d'ape x 5	71-7892-60-00
Weichzeichnerlinse x 5 Sagomatore di fascio x 5	71-7893-00-00
Beton-Unterputzset 40-42 Kit incasso in cemento 40-42	71-5618-60-00
Visueller Komfort Schwarz Comfort visivo nero	71-7524-60-00
Schirm x 5 Screen x 5	71-7894-60-00

PLAY

Raw Racy Gold

BODY MAT AL	IP 54	320°	+40°		WELL	
----------------	----------	------	------	--	------	--

Codebeispiel / Esempio di codice: AG58-P7V9S2OUEP

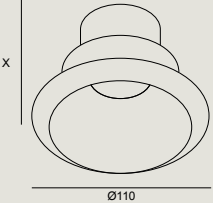
Model	W	K/ CRI/ Real lm	Optics	Source	Finishes												
 <p>AG58 - Rund / Fest Rotondo / Fisso Ⓢ 100 IP54 ⤴ +40° ⤵ 320°</p> <table border="1"> <tr> <th>W</th> <th>X</th> </tr> <tr> <td>7 W</td> <td>105</td> </tr> <tr> <td>13 W</td> <td>125</td> </tr> <tr> <td>18 W</td> <td>145</td> </tr> <tr> <td>Warm-dim</td> <td>140</td> </tr> <tr> <td>GU10 MR16*</td> <td>95</td> </tr> </table>  <p>Ø110</p>	W	X	7 W	105	13 W	125	18 W	145	Warm-dim	140	GU10 MR16*	95	P7 6,4W	V9 2700K/CRI90 514 lm W9 3000K/CRI90 624 lm X9 4000K/CRI90 624 lm	S2 14° M2 28° F1 49°	OU ON-OFF 100-240V /50-60Hz TS PHASE CUT 220-240V/50-60Hz DS DALI-2 220-240V/ 50-60Hz BB 9V/Max. 700mA M2 Emergency ON-OFF 1H 220-240V/50-60Hz O3 Emergency ON-OFF 3H 220-240V/50-60Hz D1 Emergency DALI 1H 220-240V/50-60Hz D3 Emergency DALI 3H 220-240V/50-60Hz	EP
	W	X															
	7 W	105															
	13 W	125															
	18 W	145															
	Warm-dim	140															
	GU10 MR16*	95															
	13 11,9W	V9 2700K/CRI90 1048 lm W9 3000K/CRI90 1211 lm X9 4000K/CRI90 1296 lm	S2 19° M2 34° F1 45°	OU ON-OFF/100-240V 50-60Hz TS PHASE CUT 220-240V/50-60Hz DS DALI-2 220-240V/ 50-60Hz BB 36V/Max. 350mA M2 Emergency ON-OFF 1H 220-240V/50-60Hz O3 Emergency ON-OFF 3H 220-240V/50-60Hz D1 Emergency DALI 1H 220-240V/50-60Hz D3 Emergency DALI 3H 220-240V/50-60Hz													
	18 17.7W	V9 2700K/CRI90 1362 lm W9 3000K/CRI90 1636 lm X9 4000K CRI90 1722 lm	S2 19° M2 33° F1 47°	OU ON-OFF/100-240V 50-60Hz TS PHASE CUT 220-240V/50-60Hz DS DALI-2 220-240V/ 50-60Hz BB 36V/Max. 500mA													
	13 11.9W	S9 Warm Dimming 1800K - 3000K CRI 95/957 lm	S2 19° M2 34°	TS PHASE CUT 220-240V/50-60Hz													
	12 12.5W	U9 TW 2700K-6500K CRI90/1013 lm	F1 45°	TW DALI DT8 220-240V/ 50-60Hz													
	AA GU10	G1	NA	BU 100-240V/50-60Hz													

P. 940

nicht inklusive / Non incluso	
Visueller Komfort Weiß / Comfort visivo bianco	71-4754-14-00
Visueller Komfort Schwarz / Comfort visivo nero	71-4754-60-00
Wabenraster x 5 / Pannello a nido d'ape (5 unità)	71-5166-60-00
Elliptischer Diffusor x 5 / Diffusore ellittico (5 unità)	71-5167-00-00
Quadratischer Diffusor x 5 / Diffusore quadrato (5 unità)	71-5658-00-00
Weichzeichnerlinse x 5 / Sagomatore di fascio (5 unità)	71-6099-00-00
Schirm x 5 / Screen x 5	71-7895-60-00
Smart Compatible-Zub. / Access. Smart Compatibile	
71-5959-00-00 Dimmer Phase Cut Casambi (TS)	
71-5961-00-00 Dimmer DALI Casambi (DS) (TW)	
71-A260-00-00 Driver Casambi 350-1050mA 38W (BB)	

PLAY

Raw

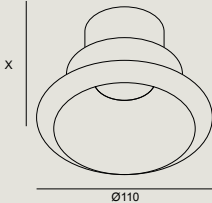

Codebeispiel / Esempio di codice: AG59-P7V9S20U55

Model	W	K/ CRI/ Real lm	Optics	Source	Finishes												
 <p>AG59 - Rund / Fest Rotondo / Fisso 100 IP54</p> <table border="1"> <tr><td>W</td><td>X</td></tr> <tr><td>7 W</td><td>105</td></tr> <tr><td>13 W</td><td>125</td></tr> <tr><td>18 W</td><td>145</td></tr> <tr><td>Warm-dim</td><td>140</td></tr> <tr><td>GU10 MR16*</td><td>95</td></tr> </table> 	W	X	7 W	105	13 W	125	18 W	145	Warm-dim	140	GU10 MR16*	95	P7 6,4W	V9 2700K/CRI90 512 lm	S2 15°	OU ON-OFF 100-240V/ 50-60Hz	55
	W	X															
	7 W	105															
	13 W	125															
	18 W	145															
	Warm-dim	140															
	GU10 MR16*	95															
	W9 3000K/CRI90 601 lm	M2 32°	TS PHASE CUT 220-240V/ 50-60Hz	EN													
	X9 4000K/CRI90 610 lm	F1 49°	DS DALI-2 220-240V/ 50-60Hz	EO													
	13 11,9W	V9 2700K/CRI90 1104 lm	S2 20°	OU ON-OFF 100-240V/ 50-60Hz	55												
						W9 3000K/CRI90 1250 lm	M2 34°	TS PHASE CUT 220-240V/ 50-60Hz	EN								
						X9 4000K/CRI90 1350 lm	F1 46°	DS DALI-2 220-240V/ 50-60Hz	EO								
		18 17.7W	V9 2700K/CRI90 1394 lm	S2 20°	OU ON-OFF 100-240V/50-60Hz	55											
							W9 3000K/CRI90 1624 lm	M2 33°	TS PHASE CUT 220-240V /50-60Hz	EN							
							X9 4000K/CRI90 1704 lm	F1 46°	DS DALI-2 220-240V/ 50-60Hz	EO							
		13 11.9W	S9 Warm Dimming 1800K - 3000K CRI95/987 lm	S2 20°	TS PHASE CUT 220-240V/ 50-60Hz	55											
							M2 34°	BB Emergency ON-OFF 3H/220-240V 50-60Hz	D1 Emergency DALI 1H/ 220-240V 50-60Hz	D3 Emergency DALI 3H 220-240V/50-60Hz							
											BB Emergency 36V/Max. 350mA	D1 Emergency DALI 1H/ 220-240V 50-60Hz	D3 Emergency DALI 3H 220-240V/50-60Hz				
		12 12.5W	U9 TW 2700K-6500K CRI90/1023 lm	F1 47°	TW DALI DT8 220-240V / 50-60Hz	55											
		AA GU10	G1	NA	BU 100-240V/50-60Hz	55											

P. 940

nicht inklusive / Non incluso

Visueller Komfort Weiß / Comfort visivo bianco	71-4754-14-00
Visueller Komfort Schwarz / Comfort visivo nero	71-4754-60-00
Wabenraster x 5 / Pannello a nido d'ape (5 unità)	71-5166-60-00
Elliptischer Diffusor x 5 / Diffusore ellittico (5 unità)	71-5167-00-00
Quadratischer Diffusor x 5 / Diffusore quadrato (5 unità)	71-5658-00-00
Weichzeichnerlinse x 5 / Sagomatore di fascio (5 unità)	71-6099-00-00
Schirm x 5 / Screen x 5	71-7895-60-00











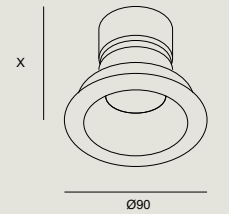















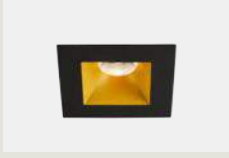
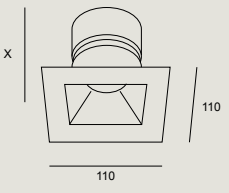







Smart Compatible-Zub. / Access. Smart Compatibile

71-5959-00-00	Dimmer Phase Cut Casambi (TS)
71-5961-00-00	Dimmer DALI Casambi (DS) (TW)
71-A260-00-00	Driver Casambi 350-1050mA 38W (BB)



Deco Symmetrical Trim

Codebeispiel / Esempio di codice: AG23-P7V9S2OUWR

Model	W	K/ CRI/ Real lm	Optics	Source	Finishes												
 <p>AG23 - Rund / Fest Rotondo / Fisso ⌀ 80 IP54</p> <table border="1"> <thead> <tr><th>W</th><th>X</th></tr> </thead> <tbody> <tr><td>7 W</td><td>90</td></tr> <tr><td>13 W</td><td>110</td></tr> <tr><td>18 W</td><td>130</td></tr> <tr><td>Warm-dim</td><td>125</td></tr> <tr><td>GU10 MR16*</td><td>80</td></tr> </tbody> </table> 	W	X	7 W	90	13 W	110	18 W	130	Warm-dim	125	GU10 MR16*	80	P7 6,4W	V9 2700K/CRI90 527 lm	S2 14°	OU  ON-OFF 100-240V / 50-60Hz	WR 
	W	X															
	7 W	90															
	13 W	110															
	18 W	130															
	Warm-dim	125															
	GU10 MR16*	80															
	W9 3000K/CRI90 624 lm	M2 28°	TS  PHASE CUT 220-240V/50-60Hz	WG 													
	X9 4000K/CRI90 624 lm	F1 49°	DS  DALI-2 220-240V/ 50-60Hz	WH 													
		BB  9V/Max. 700mA	WI 														
		M2 28°	O1  Emergency ON-OFF 1H/220- 240V/50-60Hz	WJ 													
		O3  Emergency ON-OFF 3H 220-240V/50-60Hz	WL 														
	D1  Emergency DALI 1H 220-240V/50-60Hz	WM 															
	D3  Emergency DALI 3H 220-240V/50-60Hz	WN 															
 <p>AG27 - Quadratisch / Fest Quadrato / Fisso ⌀ 100 IP54</p> <table border="1"> <thead> <tr><th>W</th><th>X</th></tr> </thead> <tbody> <tr><td>7 W</td><td>90</td></tr> <tr><td>13 W</td><td>110</td></tr> <tr><td>18 W</td><td>130</td></tr> <tr><td>Warm-dim</td><td>125</td></tr> <tr><td>GU10 MR16*</td><td>80</td></tr> </tbody> </table> 	W	X	7 W	90	13 W	110	18 W	130	Warm-dim	125	GU10 MR16*	80	13 11,9W	V9 2700K/CRI90 876 lm	S2 21°	OU  ON-OFF 100-240V/ 50-60Hz	
	W	X															
	7 W	90															
	13 W	110															
	18 W	130															
	Warm-dim	125															
	GU10 MR16*	80															
	W9 3000K/CRI90 1271 lm	M2 34°	TS  PHASE CUT 220-240V/50-60Hz														
	X9 4000K/CRI90 1360 lm	F1 45°	DS  DALI-2 220-240V/50-60Hz														
		BB  36V/Max. 350mA	BB 														
		M2 34°	O1  Emergency ON-OFF 1H 220-240V/50-60Hz														
		O3  Emergency ON-OFF 3H 220-240V/50-60Hz	O3 														
	D1  Emergency DALI 1H 220-240V/50-60Hz	D1 															
	D3  Emergency DALI 3H 220-240V/50-60Hz	D3 															
18 17.7W	V9 2700K/CRI90 1615 lm	S2 22°	OU  ON-OFF 100-240V/ 50-60Hz														
	W9 3000K/CRI90 1610 lm	M2 33°	TS  PHASE CUT 220-240V/50-60Hz														
	X9 4000K/CRI90 1477 lm	F1 51°	DS  DALI-2 220-240V/ 50-60Hz														
13 11.9W	S9 Warm Dimming 1800K - 3000K CRI95/1004 lm	S2 19°	TS  PHASE CUT 220-240V/50-60Hz														
		M2 34°															
12 12.5W	U9 TW 2700K-6500K CRI90/1036 lm	F1 45°	TW  DALI DT8/220-240V 50-60Hz														
AA GU10	G1	NA	BU 220-240V/50-60Hz														

 P. 940

nicht inklusive / Non incluso

Visueller Komfort Weiß / Comfort visivo bianco	71-4754-14-00
Visueller Komfort Schwarz / Comfort visivo nero	71-4754-60-00
Wabenraster x 5 / Pannello a nido d'ape (5 unità)	71-5166-60-00
Elliptischer Diffusor x 5 / Diffusore ellittico (5 unità)	71-5167-00-00
Quadratischer Diffusor x 5 / Diffusore quadrato (5 unità)	71-5658-00-00
Weichzeichnerlinse x 5 / Sagomatore di fascio (5 unità)	71-6099-00-00
Schirm x 5 / Screen x 5	71-7895-60-00

Smart Compatible-Zub. / Access. Smart Compatibile

71-5959-00-00	Dimmer Phase Cut Casambi (TS)
71-5961-00-00	Dimmer DALI Casambi (DS) (TW)
71-A260-00-00	Driver Casambi 350-1050mA 38W (BB)

PLAY

Deco Symmetrical Trimless

DIF MAT	IP	50000h		WELL	
PMMA	54	L80 B20			

Codebeispiel / Esempio di codice: AG24-P7V9S2OUWP

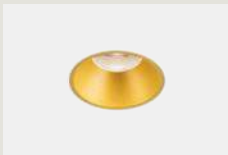
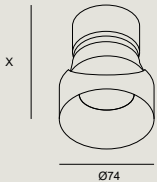
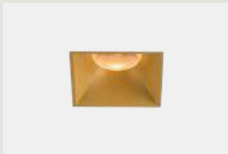
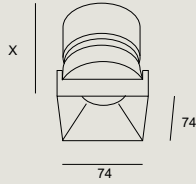
Model	W	K/ CRI/ Real lm	Optics	Source	Finishes												
 <p>AG24 - Rund fest randlos Rotondo fisso senza cornice Ø 75 IP54</p> <table border="1"> <thead> <tr> <th>W</th> <th>X</th> </tr> </thead> <tbody> <tr> <td>7 W</td> <td>95</td> </tr> <tr> <td>13 W</td> <td>115</td> </tr> <tr> <td>18 W</td> <td>135</td> </tr> <tr> <td>Warm-dim</td> <td>130</td> </tr> <tr> <td>GU10 MR16*</td> <td>85</td> </tr> </tbody> </table> 	W	X	7 W	95	13 W	115	18 W	135	Warm-dim	130	GU10 MR16*	85	P7 6,4W	V9 2700K/CRI90 509 lm	S2 14°	OU ON-OFF 100-240V /50-60Hz	WP WS WQ
	W	X															
	7 W	95															
	13 W	115															
	18 W	135															
	Warm-dim	130															
	GU10 MR16*	85															
	W9 3000K/CRI90 527 lm	M2 27°	TS PHASE CUT 220-240V/50-60Hz														
	X9 4000K/CRI90 558 lm	F1 48°	DS DALI-2 220-240V/ 50-60Hz BB 9V/Max. 700mA														
				M2 27°	O1 Emergency ON-OFF 1H 220-240V/50-60Hz												
				O3 Emergency ON-OFF 3H 220-240V/50-60Hz													
				D1 Emergency DALI 1H 220-240V/50-60Hz													
				D3 Emergency DALI 3H /220-240V/50-60Hz													
 <p>AG28 - Quadratisch fest randlos Quadrato fisso senza cornice 75x75 IP54</p> <table border="1"> <thead> <tr> <th>W</th> <th>X</th> </tr> </thead> <tbody> <tr> <td>7 W</td> <td>95</td> </tr> <tr> <td>13 W</td> <td>115</td> </tr> <tr> <td>18 W</td> <td>135</td> </tr> <tr> <td>Warm-dim</td> <td>130</td> </tr> <tr> <td>GU10 MR16*</td> <td>85</td> </tr> </tbody> </table> 	W	X	7 W	95	13 W	115	18 W	135	Warm-dim	130	GU10 MR16*	85	13 11,9W	V9 2700K/CRI90 1011 lm	S2 19°	OU ON-OFF/100-240V/ 50-60Hz	
	W	X															
	7 W	95															
	13 W	115															
	18 W	135															
	Warm-dim	130															
	GU10 MR16*	85															
	W9 3000K/CRI90 1169 lm	M2 34°	TS PHASE CUT/ 220-240V/50-60Hz														
	X9 4000K/CRI90 1251 lm	F1 45°	DS DALI-2/220-240V/ 50-60Hz BB 36V/Max. 350mA														
				M2 34°	O1 Emergency ON-OFF 1H 220-240V/50-60Hz												
					O3 Emergency ON-OFF 3H 220-240V/50-60Hz												
					D1 Emergency DALI 1H /220-240V/50-60Hz												
					D3 Emergency DALI 3H 220-240V/50-60Hz												
	18 17.7W	V9 2700K/CRI90 1301 lm	S2 19°	OU ON-OFF 100-240V/ 50-60Hz													
W9 3000K/CRI90 1530 lm		M2 33°	TS PHASE CUT 220-240V/50-60Hz														
X9 4000K/CRI90 1641 lm		F1 46°	DS DALI-2 220-240V/ 50-60Hz BB 36V/Max. 500mA														
	13 11.9W	S9 Warm Dimming 1800K - 3000K CRI95/923 lm	S2 19°	TS PHASE CUT 220-240V/50-60Hz													
			M2 34°														
	12 12.5W	U9 TW 2700K-6500K CRI90/982 lm	F1 45°	TW DALI DT8 220-240V/ 50-60Hz													
	AA GU10	G1	NA	BU 220-240V/50-60Hz													

P. 940

nicht inklusive / Non incluso	
Visueller Komfort Weiß / Comfort visivo bianco	71-4754-14-00
Visueller Komfort Schwarz / Comfort visivo nero	71-4754-60-00
Wabenraster x 5 / Pannello a nido d'ape (5 unità)	71-5166-60-00
Elliptischer Diffusor x 5 / Diffusore ellittico (5 unità)	71-5167-00-00
Quadratischer Diffusor x 5 / Diffusore quadrato (5 unità)	71-5658-00-00
Weichzeichnerlinse x 5 / Sagomatore di fascio (5 unità)	71-6099-00-00
Schirm x 5 / Screen x 5	71-7895-60-00











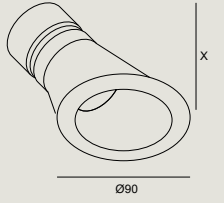













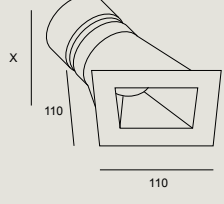







Smart Compatible-Zub. / Access. Smart Compatibile	
71-5959-00-00	Dimmer Phase Cut Casambi (TS)
71-5961-00-00	Dimmer DALI Casambi (DS) (TW)
71-A260-00-00	Driver Casambi 350-1050mA 38W (BB)

INDOOR DOWNLIGHTS / DOWNLIGHTS



Deco Asymmetrical Trim

Codebeispiel / Esempio di codice: AG25-P7V9S2OUWR

Model	W	K/CRI/Real lm	Optics	Source	Finishes												
 <p>AG25 - Rund / Fest Rotondo / Fisso Ⓢ 80 IP54</p> <table border="1"> <thead> <tr> <th>W</th> <th>X</th> </tr> </thead> <tbody> <tr><td>7 W</td><td>95</td></tr> <tr><td>13 W</td><td>115</td></tr> <tr><td>18 W</td><td>135</td></tr> <tr><td>Warm-dim</td><td>130</td></tr> <tr><td>GU10 MR16*</td><td>85</td></tr> </tbody> </table> 	W	X	7 W	95	13 W	115	18 W	135	Warm-dim	130	GU10 MR16*	85	P7 6,4W	V9 2700K/CRI90/ 509 lm	S2 14°	OU  ON-OFF/100-240V/ 50-60Hz	WR 
	W	X															
	7 W	95															
	13 W	115															
	18 W	135															
	Warm-dim	130															
	GU10 MR16*	85															
	W9 3000K/CRI90/ 527 lm	M2 27°	TS  PHASE CUT/ 220-240V/50-60Hz	WG 													
	X9 4000K/CRI90/ 612 lm	F1 48°	DS  DALI-2/220-240V/ 50-60Hz	WH 													
		BB  9V/Max. 700mA	WI 														
		M2 27°	O1  Emergency ON-OFF 1H/220-240V/ 50-60Hz	WJ 													
		O3  Emergency ON-OFF 3H/220-240V/ 50-60Hz	WK 														
 <p>AG29 - Quadratisch / Fest Quadrato / Fisso Ⓢ 100 IP54</p> <table border="1"> <thead> <tr> <th>W</th> <th>X</th> </tr> </thead> <tbody> <tr><td>7 W</td><td>90</td></tr> <tr><td>13 W</td><td>110</td></tr> <tr><td>18 W</td><td>125</td></tr> <tr><td>Warm-dim</td><td>120</td></tr> <tr><td>GU10 MR16*</td><td>90</td></tr> </tbody> </table> 	W	X	7 W	90	13 W	110	18 W	125	Warm-dim	120	GU10 MR16*	90	13 11,9W	V9 2700K/CRI90/ 785 lm	S2 19°	OU  ON-OFF/100-240V/ 50-60Hz	WM 
	W	X															
	7 W	90															
	13 W	110															
	18 W	125															
	Warm-dim	120															
	GU10 MR16*	90															
	W9 3000K/CRI90/ 1271 lm	M2 34°	TS  PHASE CUT/ 220-240V/50-60Hz	WN 													
	X9 4000K/CRI90/ 1360 lm	F1 45°	DS  DALI-2/220-240V/ 50-60Hz														
		BB  36V/Max. 350mA	D1  Emergency DALI 1H /220-240V/50-60Hz														
		M2 34°	O1  Emergency ON-OFF 1H/220-240V/ 50-60Hz														
		O3  Emergency ON-OFF 3H/220-240V/ 50-60Hz	D3  Emergency DALI 3H /220-240V/50-60Hz														
18 17.7W	V9 2700K/CRI90/ 1554 lm	S2 21°	OU  ON-OFF/100-240V/ 50-60Hz														
	W9 3000K/CRI90/ 1554 lm	M2 33°	TS  PHASE CUT/ 220-240V/50-60Hz														
	X9 4000K/ CRI90/1389 lm	F1 45°	DS  DALI-2/220-240V/ 50-60Hz														
		BB  36V/Max. 500mA	BB 														
		S2 19°	TS  PHASE CUT/ 220-240V/50-60Hz														
		M2 34°															
13 11.9W	S9 Warm Dimming 1800K - 3000K/ CRI 95/923 lm	S2 19°	TS  PHASE CUT/ 220-240V/50-60Hz														
12 12.5W	U9 TW 2700K-6500K/ CRI90/982 lm	F1 45°	TW  DALI DT8/220-240V /50-60Hz														
AA GU10	G1	NA	BU 220-240V/50-60Hz														

P. 940

nicht inklusive / Non incluso

Visueller Komfort Weiß / Comfort visivo bianco	71-4754-14-00
Visueller Komfort Schwarz / Comfort visivo nero	71-4754-60-00
Wabenraster x 5 / Pannello a nido d'ape (5 unità)	71-5166-60-00
Elliptischer Diffusor x 5 / Diffusore ellittico (5 unità)	71-5167-00-00
Quadratischer Diffusor x 5 / Diffusore quadrato (5 unità)	71-5658-00-00
Weichzeichnerlinse x 5 / Sagomatore di fascio (5 unità)	71-6099-00-00
Schirm x 5 / Screen x 5	71-7895-60-00

Smart Compatible-Zub. / Access. Smart Compatibile





71-5959-00-00	Dimmer Phase Cut Casambi (TS)
71-5961-00-00	Dimmer DALI Casambi (DS) (TW)
71-A260-00-00	Driver Casambi 350-1050mA 38W (BB)

PLAY

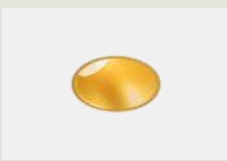
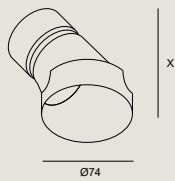

Deco
Asymmetrical
Trimless

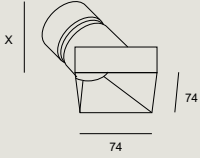
Codebeispiel / Esempio di codice: AG26-P7V9S2OUWP

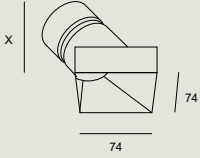
Model	W	K/ CRI/ Real lm	Optics	Source	Finishes												
 <p>AG26 - Rund fest randlos Rotondo fisso senza cornice Ⓜ 75 IP54</p> <table border="1"> <thead> <tr> <th>W</th> <th>X</th> </tr> </thead> <tbody> <tr> <td>7 W</td> <td>95</td> </tr> <tr> <td>13 W</td> <td>115</td> </tr> <tr> <td>18 W</td> <td>125</td> </tr> <tr> <td>Warm-dim</td> <td>120</td> </tr> <tr> <td>GU10 MR16*</td> <td>90</td> </tr> </tbody> </table> 	W	X	7 W	95	13 W	115	18 W	125	Warm-dim	120	GU10 MR16*	90	P7 6,4W	V9 2700K/CRI90 509 lm	S2 14°	OU ON-OFF 100-240V/ 50-60Hz	WP WS WQ
	W	X															
	7 W	95															
	13 W	115															
	18 W	125															
	Warm-dim	120															
	GU10 MR16*	90															
	W9 3000K/CRI90 527 lm	M2 27°	TS PHASE CUT 220-240V/50-60Hz														
	X9 4000K/CRI90 558 lm	F1 48°	DS DALI-2 220-240V/ 50-60Hz														
	 <p>AG31 - Quadratisch fest randlos Quadrato fisso senza cornice Ⓜ 75x75 IP54</p> <table border="1"> <thead> <tr> <th>W</th> <th>X</th> </tr> </thead> <tbody> <tr> <td>7 W</td> <td>95</td> </tr> <tr> <td>13 W</td> <td>115</td> </tr> <tr> <td>18 W</td> <td>125</td> </tr> <tr> <td>Warm-dim</td> <td>120</td> </tr> <tr> <td>GU10 MR16*</td> <td>90</td> </tr> </tbody> </table> 	W	X	7 W	95	13 W	115	18 W	125	Warm-dim	120	GU10 MR16*	90	13 11,9W	V9 2700K/CRI90 1011 lm	S2 19°	OU ON-OFF 100-240V/50-60Hz
W		X															
7 W		95															
13 W		115															
18 W		125															
Warm-dim		120															
GU10 MR16*		90															
W9 3000K/CRI90 1169 lm		M2 34°	TS PHASE CUT 220-240V/50-60Hz														
X9 4000K/CRI90 1251 lm		F1 45°	DS DALI-2 220-240V/ 50-60Hz														
 <p>AG31 - Quadratisch fest randlos Quadrato fisso senza cornice Ⓜ 75x75 IP54</p> <table border="1"> <thead> <tr> <th>W</th> <th>X</th> </tr> </thead> <tbody> <tr> <td>7 W</td> <td>95</td> </tr> <tr> <td>13 W</td> <td>115</td> </tr> <tr> <td>18 W</td> <td>125</td> </tr> <tr> <td>Warm-dim</td> <td>120</td> </tr> <tr> <td>GU10 MR16*</td> <td>90</td> </tr> </tbody> </table> 		W	X	7 W	95	13 W	115	18 W	125	Warm-dim	120	GU10 MR16*	90	18 17.7W	V9 2700K/CRI90 1301 lm	S2 19°	OU ON-OFF 100-240V/ 50-60Hz
	W	X															
	7 W	95															
	13 W	115															
	18 W	125															
	Warm-dim	120															
	GU10 MR16*	90															
	W9 3000K/CRI90 1530 lm	M2 33°	TS PHASE CUT 220-240V/50-60Hz														
	X9 4000K/CRI90 1641 lm	F1 46°	DS DALI-2 220-240V/ 50-60Hz														
	13 11.9W	S9 Warm Dimming 1800K - 3000K CRI95/923 lm	S2 19°	TS PHASE CUT 220-240V/50-60Hz													
M2 34°																	
12 12.5W	U9 TW 2700K-6500K/ CRI90/982 lm	F1 45°	TW DALI DT8 220-240V/ 50-60Hz														
AA GU10	G1	NA	BU 220-240V/50-60Hz														

P.940



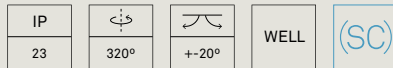

nicht inklusive / Non incluso	
Visueller Komfort Weiß / Comfort visivo bianco	71-4754-14-00
Visueller Komfort Schwarz / Comfort visivo nero	71-4754-60-00
Wabenraster x 5 / Pannello a nido d'ape (5 unità)	71-5166-60-00
Elliptischer Diffusor x 5 / Diffusore ellittico (5 unità)	71-5167-00-00
Quadratischer Diffusor x 5 / Diffusore quadrato (5 unità)	71-5658-00-00
Weichzeichnerlinse x 5 / Sagomatore di fascio (5 unità)	71-6099-00-00
Schirm x 5 / Screen x 5	71-7895-60-00

Smart Compatible-Zub. / Access. Smart Compatibile	
71-5959-00-00	Dimmer Phase Cut Casambi (TS)
71-5961-00-00	Dimmer DALI Casambi (DS) (TW)
71-A260-00-00	Driver Casambi 350-1050mA 38W (BB)

INDOOR DOWNLIGHTS / DOWNLIGHTS

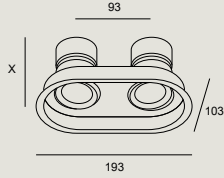

Codebeispiel / Esempio di codice: AG42-P7V9S2OU14

Model	W	K/ CRI/ Real lm	Optics	Source	Finishes												
 <p>AG42 - Rund / Schwenkbar Rotondo / Regolabile 95x93 IP23 +20° 320°</p> <table border="1"> <thead> <tr> <th>W</th> <th>X</th> </tr> </thead> <tbody> <tr> <td>7 W</td> <td>95</td> </tr> <tr> <td>13 W</td> <td>115</td> </tr> <tr> <td>18 W</td> <td>135</td> </tr> <tr> <td>Warm-dim</td> <td>130</td> </tr> <tr> <td>GU10 MR16*</td> <td>85</td> </tr> </tbody> </table> 	W	X	7 W	95	13 W	115	18 W	135	Warm-dim	130	GU10 MR16*	85	P7 2 x 6,4W (12,8W)	V9 2700K/CRI 90 2 x 571 lm (1124 lm) W9 3000K/CRI 90 2 x 664 lm (1324 lm) X9 4000K/CRI 90 2 x 664 lm (1324 lm)	S2 14° M2 28° F1 49°	OU ON-OFF 100-240V /50-60Hz TS PHASE CUT 220-240V/50-60Hz DS DALI-2 220-240V /50-60Hz BB 9V/Max. 700mA	14  23  60 
	W	X															
	7 W	95															
	13 W	115															
	18 W	135															
	Warm-dim	130															
	GU10 MR16*	85															
	13 2 x 11,9W (23,8W)	V9 2700K/CRI90 2 x 1222 lm (2444 lm) W9 3000K/CRI90 2 x 1315 lm (2630 lm) X9 4000K/CRI90 2 x 1407 lm (2814 lm)	S2 19° M2 34° F1 45°	OU ON-OFF 100-240V 50-60Hz TS PHASE CUT 220-240V 50-60Hz DS DALI-2 220-240V 50-60Hz BB 36V/Max. 350mA													
	18 2 x 17,7W (34,4W)	V9 2700K/CRI90 2 x 1596 lm (3192 lm) W9 3000K/CRI90 2 x 1718 lm (3436 lm) X9 4000K/CRI90 2 x 1838 lm (3676 lm)	S2 19° M2 33° F1 47°	OU ON-OFF 100-240V 50-60Hz TS PHASE CUT 220-240V 50-60Hz DS DALI-2 220-240V 50-60Hz BB 36V/Max. 500mA													
	13 2 x 11,9W (23,8W)	S9 Warm Dimming 1800K - 3000K CRI95 2 x 1039 lm (2078 lm)	S2 19° M2 34° F1 45°	TS PHASE CUT 220-240V/ 50-60Hz													
	AA 2 x GU10	G1	NA	BU 220-240V/ 50-60Hz													

 P. 940

nicht inklusive / Non incluso	
Visueller Komfort Weiß / Comfort visivo bianco	71-4754-14-00
Visueller Komfort Schwarz / Comfort visivo nero	71-4754-60-00
Wabenraster x 5 / Pannello a nido d'ape (5 unità)	71-5166-60-00
Elliptischer Diffusor x 5 / Diffusore ellittico (5 unità)	71-5167-00-00
Quadratischer Diffusor x 5 / Diffusore quadrato (5 unità)	71-5658-00-00
Weichzeichnerlinse x 5 / Sagomatore di fascio (5 unità)	71-6099-00-00
Schirm x 5 / Screen x 5	71-7895-60-00

Smart Compatible-Zub./ Access. Smart Compatibile	
71-5961-00-00	Dimmer DALI Casambi (DS)

PLAY

Deco Surface

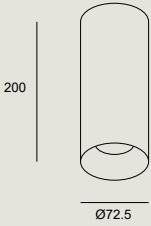

Codebeispiel / Esempio di codice: AG32-P7V9S20UWR

Model	W	K/ CRI/ Real lm	Optics	Source	Finishes
 <p>AG32 - Rund / Fest Rotondo / Fisso ⓘ 200 IP23</p> 	P7 6,4W	V9 2700K/CRI90 521 lm	S2 14°	OU ON-OFF/100-240V 50-60Hz	WR
		W9 3000K/CRI90 637 lm	M2 28°	TS PHASE CUT 220-240V 50-60Hz	WG
		X9 4000K/CRI90 642 lm	F1 49°	DS DALI-2 220-240V /50-60Hz	WH
	13 11,9W	V9 2700K/CRI90 1070 lm	S2 19°	OU ON-OFF/100-240V 50-60Hz	WM
		W9 3000K/CRI90 1276 lm	M2 35°	TS PHASE CUT 220-240V 50-60Hz	WN
		X9 4000K/CRI90 1344 lm	F1 45°	DS DALI-2 220-240V /50-60Hz	

P. 940

nicht inklusive / Non incluso

Installationsset Strahler Aufputz weiß Kit installazione proiettore di superficie bianco	71-5171-14-14
Installationsset Strahler Aufputz schwarz Kit installazione proiettore di superficie nero	71-5175-60-60
Aufhängeset 1500 mm Weiß Kit per sospensione ventilatori 1500mm colore bianco	71-5174-14-14
Aufhängeset 1500 mm Schwarz Kit per sospensione ventilatori 1500mm colore nero	71-5174-60-14
Installationsset Strahler Dreiphasenschiene weiß Kit installazione proiettore per binario trifase bianco	71-6481-14-14
Installationsset Strahler Dreiphasenschiene schwarz Kit installazione proiettore per binario trifase nero	71-6481-60-60

Smart Compatible-Zub. / Access. Smart Compatibile

71-5961-00-00 Dimmer DALI Casambi (DS)
71-5959-00-00 Dimmer Phase Cut Casambi (TS)



Lite

BODY MAT		50000h	3
PC,G		L80 B20	MacAdam



Lite ist eine Kollektion von kompakten und starren Downlights mit hohem Sehkomfort.

Lite è una collezione di faretto con un design compatto e fisso e con un gran comfort visivo.

Verschiedene Optionen Diverse opzioni

Erhältlich in 3 Größen mit 3 Farbtemperaturen (2700 K, 3000 K und 4000 K).

È disponibile in 3 misure ed in 3 temperature di colore (2700, 3000 e 4000K).



Ø 75



Ø 88



Ø 105

Hervorragender Sehkomfort Grande comfort visivo

Mit einer Vielzahl von Zubehörteilen, die einen hohen Sehkomfort garantieren: elliptische und quadratische Diffusoren, Wabenraster, Weichzeichnerlinse, visueller Komfort und Screen, die alle eine Anpassung des Lichtstrahls an die Anforderungen des Raums ermöglichen.

Dispone di numerosi accessori che garantiscono un grande comfort visivo: diffusori ellittici, quadrati, pannello a nido d'ape, diffusore dell'alone, comfort visivo e screen. Tutti permettono di adattare il fascio di luce alle esigenze dello spazio.



Lite



Lite + Elliptical



Lite + Square



Lite +
Honeycomb



Lite + Visual
Comfort



Lite + Screen

Einbauring Anello da incasso

Lite über einen Adapterrahmen, mit dem die Leuchte schnell und einfach in vom Standardmaß abweichende Einbaulöcher installiert werden kann. Das neue Zubehörteil lässt sich schnell und einfach an der Leuchte anbringen und eröffnet eine Reihe von Installationsmöglichkeiten.

Lite include un anello che permette di installare il prodotto in fori da incasso con misure diverse da quella standard. Il nuovo accessorio è collocato in modo facile e veloce sul pezzo ed apre una serie di possibilità all'installazione.



Ø75-89

Ø88-102

Ø105-119

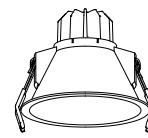
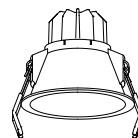
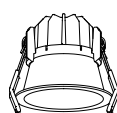

⊕ Ø65 - 79



⊕ Ø80 - 94



⊕ Ø95 - 110

Minimale Einbautiefe Profondità minima di incasso

Das mit Graphit-Technologie hergestellte Lite-Modul ermöglicht es, den Diffusor kleiner und leichter zu machen und ihn in Zwischendecken von Wohnräumen mit geringer Höhe zu installieren.

Il modulo di Lite, realizzato con la tecnologia Graphene, fa sì che il dissipatore sia più piccolo e più leggero, potendo essere installato su controsoffitti di spazi residenziali con poca altezza.



LITE

DIF MAT	IP	UGR		
PC	54	<16		ON-OFF

14

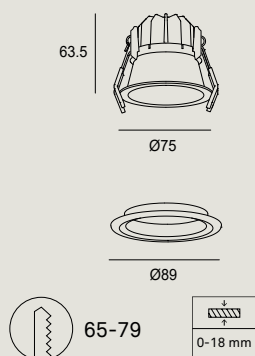

LED						
K	CRI	W LED	W Total	Real Lm	Optics	Code
2700	80	6.7	8.4	527	Medium 32°	90-A026 - 14 - 00
3000	80	6.7	8.4	527	Medium 32°	90-A027 - 14 - 00
4000	80	6.7	8.4	587	Medium 32°	90-A028 - 14 - 00
100-240V		50-60Hz				

IP	UGR		
54	<19		ON-OFF

14

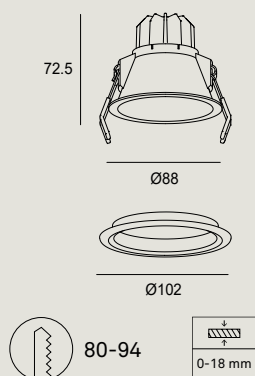

LED						
K	CRI	W LED	W Total	Real Lm	Optics	Code
2700	80	6.7	8.4	529	Flood 47°	90-8078 - 14 - 00
3000	80	6.7	8.4	529	Flood 47°	90-8079 - 14 - 00
4000	80	6.7	8.4	589	Flood 47°	90-8080 - 14 - 00
100-240V		50-60Hz				

DIF MAT	IP	UGR		
PC	54	<13		ON-OFF

14

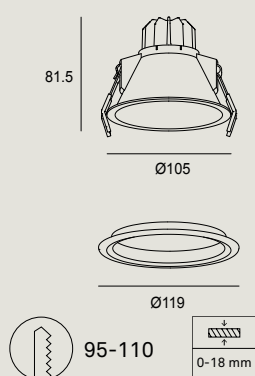

LED						
K	CRI	W LED	W Total	Real Lm	Optics	Code
2700	80	6.7	8.4	510	Medium 30°	90-A029 - 14 - 00
3000	80	6.7	8.4	510	Medium 30°	90-A030 - 14 - 00
4000	80	6.7	8.4	568	Medium 30°	90-A031 - 14 - 00
100-240V		50-60Hz				

mitgeliefertes allgemeines Zub. **Zusätzlicher Einbauring zur Anpassung an verschiedene Durchmesser**
 Access. comuni inclusi **Occhiello extra per la adattabilità a diversi diámetro**

nicht mitgeliefertes
allgemeines Zub.
 Access. comuni non inclusi

Visueller Komfort Weiß / Comfort visivo bianco	71-4754-14-00
Visueller Komfort Schwarz / Comfort visivo nero	71-4754-60-00
Wabenraster x 5 / Pannello a nido d'ape (5 unità)	71-5166-60-00
Elliptischer Diffusor x 5 / Diffusore ellittico (5 unità)	71-5167-00-00
Quadratischer Diffusor x 5 / Diffusore quadrato (5 unità)	71-5658-00-00
Weichzeichnerlinse x 5 / Sagomatore di fascio (5 unità)	71-6099-00-00
Schirm x 5 / Screen x 5	71-7895-60-00

Out

BODY MAT	DIF MAT		50000h	2
AL	GLA		L80 B20	MacAdam

Out ist eine Familie von ausschwenkbaren Einbaustrahlern. Das Gehäuse, in dem sich das optische System befindet, ist drehbar und schwenkbar. Das Licht lässt sich so auf die gewünschten Bereiche oder Objekte richten. Das vielseitige Spektrum an Optiken, Größen und Formen ermöglicht es, punktuelle oder größere Elemente zu betonen und jederzeit die gewünschte Lichtwirkung zu erzielen.

Out è una famiglia di faretti da incasso rimovibili che consentono al corpo che ospita il sistema ottico, di essere estratto dalla scatola da incasso e funzionare come un proiettore, dirigendo il fascio di luce verso gli spazi o gli oggetti desiderati. La sua versatile gamma di ottiche, dimensioni e forme, consente di enfatizzare elementi specifici o di maggior grandezza e generare l'effetto luminoso richiesto in qualsiasi momento.



Visueller Komfort Comfort visivo

Dank eines UGR-Wert < 16 weist sie minimalste Blendung und hohen Sehkomfort auf.

Offre un abbagliamento minimo ed un elevato comfort visivo, grazie ad un $UGR < 16$.



Doppelfunktion Doppia funzionalità

Die Struktur lässt eine Neigung des Gehäuses zu, das je nach den Erfordernissen des Projekts als Downlight oder als Strahler fungiert.

La sua struttura permette al corpo di inclinarsi, fungendo da downlight o da proiettore, a seconda delle esigenze del progetto.

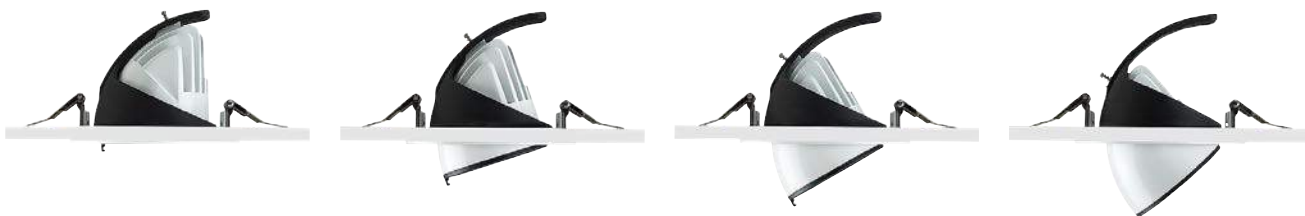

OUT

IP					
20	320°	0° a 40°			

14

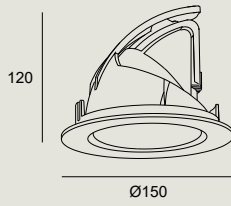



LED Max. 700mA 36V					
K	CRI	W LED	Real Lm	Optics	Code
3000	80	25.9	2200	Spot 20°	90-4781
3000	80	25.9	2190	Medium 27°	90-4782
3000	80	25.9	1939	Flood 54°	90-4783
3000	90	25.9	1665	Spot 20°	90-4791 - 14 - 37
3000	90	25.9	1658	Medium 27°	90-4792
3000	90	25.9	1467	Flood 54°	90-4793
4000	80	25.9	2200	Spot 20°	90-4788
4000	80	25.9	2190	Medium 27°	90-4789 - 14 - 37
4000	80	25.9	1939	Flood 54°	90-4790
	ON-OFF		1-10V/PUSH		CASAMBI
	DALI2/PUSH		PHASE CUT 240V		
71-6653	71-4708	71-A260	71-A192	71-A299	

nicht inklusive / Non incluso	
Vorderring Weiß Anello frontale bianco	71-5630-14-00

Dome

BODY MAT	
ST	



IP			
23			

14  23  60 

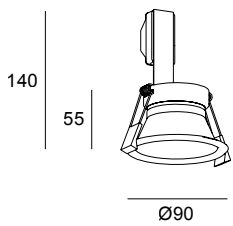

GU10		
	W	Code
	max. 50	14 DN-1600 - 23 - 00 60
 100-240V 50-60Hz		

inklusive / Incluso
Unsichtbarer Ring für LED-Lampe Anello invisibile per lampadina a LED





Dome

BODY MAT	
ST	



IP				
23	±20°			

14  60 

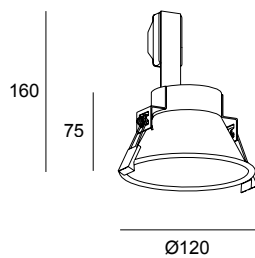



GU10		
	W	Code
	max. 50	DN-1601 - 14 - 60 - 00
 100-240V 50-60Hz		

inklusive / Incluso
Unsichtbarer Ring für LED-Lampe Anello invisibile per lampadina a LED

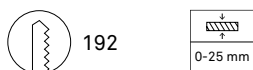
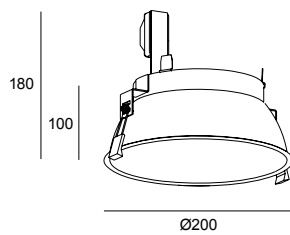

14 



GU10		
	W	Code
	max. 50	DN-1602 - 14 - 00
 100-240V 50-60Hz		





Split

BODY MAT
AL

DIF MAT
GLA



IP
65



14 21 81

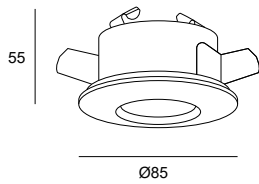

GU5.3		
	W	Code
	max. 50	14 14 90-7682 - 21 - 21 81 81
12V 50-60Hz		

nicht inklusive / Non incluso	
Zubehör für die Installation von GU10 Accessorio di installazione di GU10	71-4396-00-00



Ges

BODY MAT

PLSTER

Aufputz und Einbauoptionen Opzione da superficie e da incasso

Einfache Integration Facile integrazione

Eine Downlight-Familie aus Gips. Ideal zur Grundbeleuchtung von Innenbereichen, die sich vollständig in den Raum einfügt. Verfügbar als Aufputzoption in zylindrischer Form und als ultrakompakte Unterputzoption für eine nahtlose Einbindung in die Decke. Die Leuchtmittel sind nicht fest in die Leuchte integriert, was die Auswahl verschiedener Lichtquellen ermöglicht.

Famiglia di faretti in gesso, ideali per l'illuminazione generale di interni, con una sua totale integrazione nello spazio. Disponibile in versione da superficie, con geometria cilindrica, e in versione da incasso, ultra compatta, per una totale integrazione nel soffitto. Le lampadine non sono incluse nell'apparecchio, permettendo di offrire una gamma con diverse sorgenti luminose.



Die Kollektion bietet zwei Optionen: Aufputz (ein Modell in einer Größe) und Einbau (verschiedene Formen und Größen zur Auswahl).

La collezione dispone di due opzioni: da superficie (con un solo modello e una sola misura) e da incasso (a scelta tra diverse forme e misure).



Aufputzoptionen
Opzione da superficie



Einbauoptionen
Opzione da incasso

Die gesamte Familie ist aus Gips gefertigt und wird in Rigipsplatten eingebaut, sodass sie sich vollständig in den Raum einfügt. Es wird empfohlen, eine flexible Dichtmasse zu verwenden, um mögliche Risse und/oder Schmutzansammlungen zu vermeiden.

L'intera famiglia, realizzata in gesso, si installa sul cartongesso, permettendo che sia completamente integrata nello spazio. Si raccomanda l'uso di un sigillante flessibile per evitare possibili incrinature o accumulo di sporcizia.



GES

Gas Recessed



14

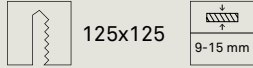
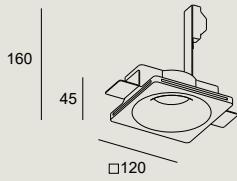

GU5.3	
W max. 35	Code 90-2902 - 14 - 00
12V 50-60Hz	

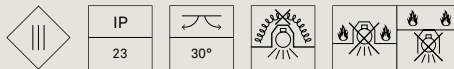

14

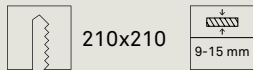
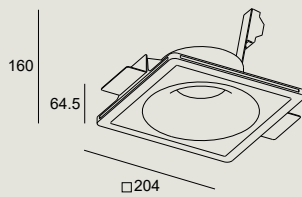

GU5.3	
W max. 35	Code 90-2903 - 14 - 00
12V 50-60Hz	

nicht mitgeliefertes
allgemeines Zub.
Access. comuni non inclusi

Zubehör für die Installation von GU10
Accessorio di installazione di GU10

71-4396-00-00

GES

Ges Recessed



14

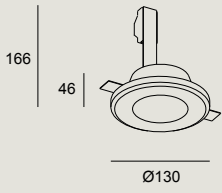

GU5.3	
W max. 35	Code 90-1720 - 14 - 00
12V 50-60Hz	

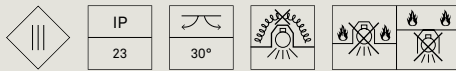
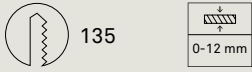

14

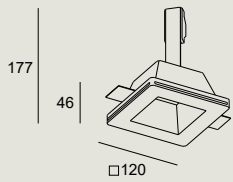

GU5.3	
W max. 35	Code 90-1722 - 14 - 00
12V 50-60Hz	

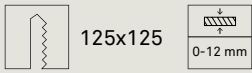

GES

Ges Surface

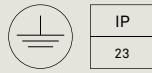

14 

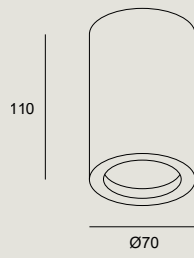

GU10	
W max. 7	Code 15-5946 - 14 - 00



Bento

Bento Standard P. 250



94 mm



173 mm



332 mm



491 mm



100 mm

Trim / Trimless
7,8 W-15,4 W



Spot 15°
Ultra Flood 50°

14 ○ 60 ●



Bento Adjustable P. 251



106 mm



186 mm

Trim
7,8 W-15,4 W



Spot 15°
Ultra Flood 50°

14 ○ 60 ●



Bento Surface P. 252



84 mm



163 mm



332 mm

Trim
7,8 W-15,4 W



Spot 15°
Ultra Flood 50°

14 ○ 60 ●

Trim
7,8 W-15,4 W

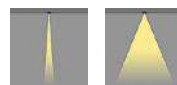

Spot 15°
Ultra Flood 50°

14 ○ 60 ●



Bento IP P. 253



117 mm



197 mm

Bento Low Voltage P. 253



99 mm



194 mm

Trim
7,8 W-15,4 W



Ultra Medium 25°
Ultra Flood 50°

14 ○ 60 ●



BENTO

50000h	3
L80 B20	MacAdam



Vídeo ansehen
Guarda il video

Minimalisierung und umfangreiche Auswahl
Miniaturizzazione e ampiezza della gamma

Eine Kollektion hochmoderner Downlights aus langjähriger Eigenentwicklung von LEDS C4 mit dem Ziel, ein Produkt zu erschaffen, das hohen visuellen Komfort und einen optimalen Wirkungsgrad bietet. Bento zeigt sich in langem und gestrecktem Design. Die multizelluläre Struktur besteht aus einzelnen optischen Modulen, wobei jede LED einen eigenen Reflektor nutzt, der extra dafür entwickelt wurde, eine gleichmäßige Ausleuchtung zu gewährleisten und einen Dark-Light-Effekt zu erzeugen. Die Leuchte wurde für moderne Räume entwickelt und bietet maximalen Komfort und Integration. Deswegen ist sie hervorragend geeignet für Büros, gemeinschaftlich genutzte Bereiche in Hotels, Konferenzräume und Ausstellungsräume.

Collezione di faretti lineari, il frutto di un lungo studio da parte degli sviluppatori del prodotto di LEDS C4 con l'obiettivo di ottenere un apparecchio con un elevato comfort visivo e con prestazioni ottimali. Con il suo design stretto ed allungato, Bento ha una struttura multi-cell e dei moduli ottici individuali, dove, ogni led, utilizza un riflettore specifico, sviluppato per garantire un'illuminazione omogenea e per creare un effetto dark-light. Questo tipo di apparecchio è progettato per essere utilizzato in spazi come uffici, aree comuni di hotel, sale conferenze ed esposizioni, dove il comfort e l'integrazione devono raggiungere il massimo livello.

Die Minimalisierung ist ein Markttrend, der darauf abzielt, extrem kleine Leuchten anzubieten, ohne dabei auf die besten technischen Eigenschaften und die vollständige Integration in den Raum zu verzichten. Bento ist eine kompakte Beleuchtungslösung mit zahlreichen Auswahlmöglichkeiten, die die Ästhetik der Architektur nicht beeinträchtigt und ein Höchstmaß an Wirkung und Effizienz bietet.

La miniaturizzazione è una tendenza di mercato che pretende offrire luminarie con dimensioni molto ridotte, senza rinunciare alle migliori prestazioni tecniche e alla sua completa integrazione nello spazio. Bento è una soluzione d'illuminazione compatta, con ampiezza della gamma, che non interferisce con l'estetica dell'architettura e che offre il massimo controllo ed efficienza.

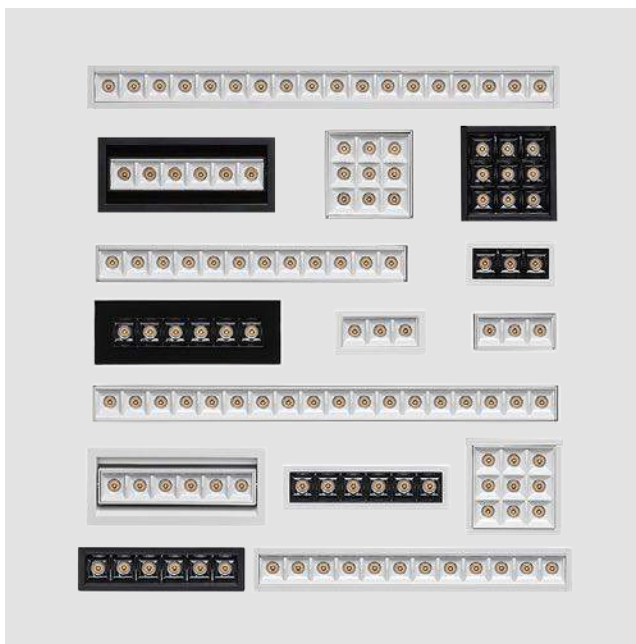

Dark-Light-Effekt Effetto Dark Light

Der Dark-Light-Effekt von Bento entsteht, wenn die Leuchte auch im eingeschalteten Zustand nicht wahrnehmbar ist, und so einzig das Licht selbst als Hauptakteur im Mittelpunkt der Szene steht.

L'effetto Dark Light di Bento si produce quando l'apparecchio, ancora acceso, scompare trasformando la luce nell'unica protagonista della scena.

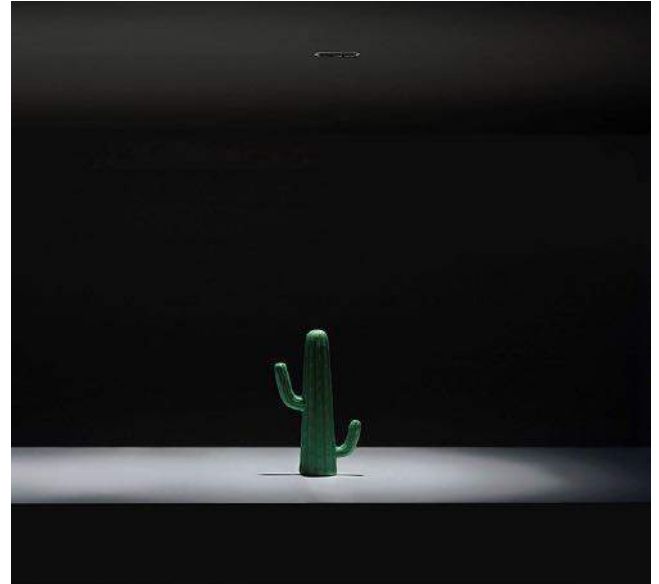

Hervorragender Sehkomfort Eccellente comfort visivo

Die Optiken von Bento sind das Ergebnis eines intensiven Entwicklungsprozesses. Die in den innovativen schwarzen oder weißen Blendschutzdiffusoren (Raster) integrierten hochauflösenden Mikroreflektoren erzeugen einen Lichtaustritt mit einem UGR < 16. Das optische System erlaubt es, die Lichtquelle zu verbergen, wodurch ein ausgezeichneter Sehkomfort mit einem Cut-Off-Winkel von 30° gewährleistet wird.

Le ottiche di Bento sono il risultato di un accurato progetto di sviluppo. I microriduttori ad alta definizione, integrati nell'innovativo diffusore antiriflesso nero o bianco (Raster), generano un'emissione con un UGR < 16. Il suo sistema ottico permette di nascondere la sorgente luminosa, garantendo, così, un ottimo comfort visivo con un angolo Cut Off di 30°.



Notlicht-Versionen Versioni di emergenza

Bento bietet Notlichtversionen für Bereiche an, in denen eine Anti-Panikbeleuchtung erforderlich ist. Diese werden mit einer LED zur Anzeige des Batteriestands geliefert, welche extern an die Einheit angeschlossen werden muss.

Bento propone versioni di emergenza per le zone che richiedono un'illuminazione antipanico. Il modello è fornito con un LED di segnalazione dello stato della batteria da installare, a distanza dal gruppo ottico.



Tunable White

Bento bietet Tunable White-Versionen zur manuellen Einstellung der Farbtemperatur oder Simulation eines natürlichen Lichtverlaufs mithilfe eines Steuerungssystems. Für den Fernzugriff ist ein DALI-System erforderlich.

Bento offre versioni Tunable White che permettono, tramite un sistema di controllo, di regolare la temperatura di colore, puntualmente, o di simulare la luce naturale. Richiede un sistema DALI per la gestione remota.



Smart-Funktionen: Lichtatmosphären Funzionalità Smart: Atmosfera luminosa

Dank der Smart-Technologie bietet Bento die Möglichkeit, mehrere Atmosphären im selben Raum zu erzeugen und die gewünschte Atmosphäre jederzeit zu betonen.

Grazie alla tecnologia Smart, Bento permette di creare numerose atmosfere nello stesso spazio, enfatizzando l'ambiente desiderato secondo il momento.

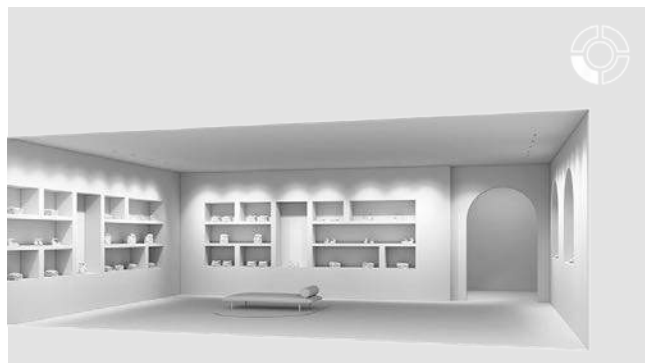
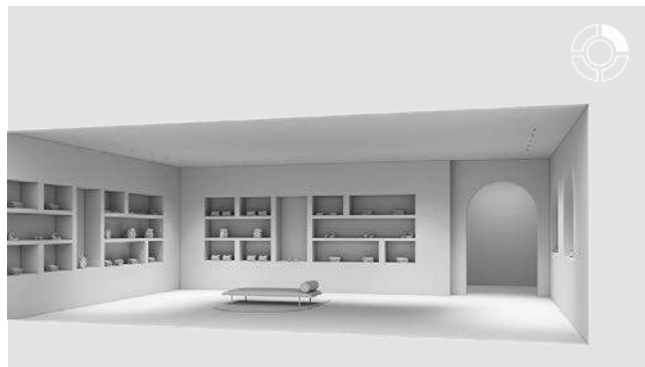



BENTO STANDARD



Die Standard Version der Familie ist in vier linearen und einer quadratischen Ausführung erhältlich, wobei die linearen mit 3, 6, 12 und 18 Lichtpunkten und die quadratischen mit 3 x 3 erhältlich sind. Mit einem UGR < 10 und dem Dark-Light-Effekt bietet Bento eine vollkommen gleichmäßige Beleuchtung.

Opzione standard della collezione, disponibile in quattro versioni lineari ed una quadrata. Quelle lineari si presentano con 3, 6, 12 e 18 punti luce, mentre quella quadrata, con 3x3. Con un UGR < 10 ed un effetto Dark Light, Bento offre una luce completamente omogenea.

Verschiedene Optionen und Ausführungen Diverse opzioni e finiture

Bento ist in einer randlosen und einer Version mit Rand erhältlich und bietet die Möglichkeit, sowohl Rahmen als auch das Innere der Optiken in Schwarz und Weiß zu wählen.

Bento è disponibile con opzione Trim/Trimless e con la possibilità di scegliere sia la cornice che l'interno delle ottiche, di color bianco e nero.

TRIM/TRIMLESS OPTION OPTION TRIM/TRIMLESS



COLOUR OPTIONS OPTIONS DE COULEUR



BENTO ADJUSTABLE



Verschiedene Optionen und Ausführungen Diverse opzioni e finiture

Bei der schwenkbaren Version kann die innere Einheit um 40° ausgerichtet werden, um so das Licht an die gewünschte Stelle zu lenken.

La versione orientabile permette il movimento della struttura interna, offrendo la possibilità di regolare il fascio di luce di 40°.

Bento Adjustable ist in zwei Ausführungen mit 3 oder 6 LEDs und mit Rahmen als auch Inneneinheit in den Farben Schwarz oder Weiß erhältlich. Die Kollektion bietet zudem eine Wandfluteroption und bewirkt dank Des niedrigen UGR-Werts von < 10 wie auch dem Dark-Light-Effekt eine vollkommen gleichmäßige Beleuchtung.

Bento Adjustable è disponibile con un'opzione 3 e 6 ottiche e con la possibilità di scegliere sia la cornice che l'interno delle ottiche, in bianco e nero. Questa collezione dispone di un wallwasher a parete ed offre una luce completamente omogenea, con un UGR 10 ed un effetto Dark Light.



BENTO SURFACE



Diese Variante ist zur Deckenaufbaumontage vorgesehen und findet überall dort Einsatz, wo eine Unterputzmontage schwierig ist. Sie besitzt dieselben Eigenschaften wie die anderen Bento-Kollektionen, nur als Aufbauversion. Erhältlich mit 3, 6 und 12 LEDs sowie den Ausstrahlwinkeln von Spot (15°) bis Flood (50°) für eine vollkommen gleichmäßige Beleuchtung.

Questa opzione è stata progettata per soffitti con difficoltà di incasso. Presenta le stesse caratteristiche della collezione Bento, nel formato da superficie. Con la scelta tra 3, 6 e 12 ottiche, offre una luce totalmente omogenea con un livello di apertura dell'angolo di luce, che va da Spot (15°) a Flood (50°).

Verschiedene Optionen und Ausführungen Diverse opzioni e finiture

Bento Surface ist mit einem weißen und einem schwarzen Gehäuse erhältlich.

Bento Surface è disponibile con opzione di scatola da incasso, in bianco e nero.

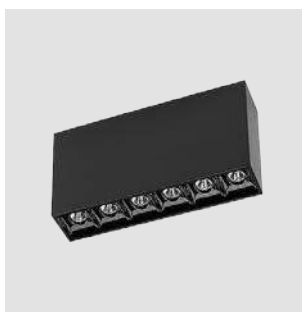

BENTO IP



Schutz nach IP65 Protezione IP65

Die Familie Bento IP enthält zwei Varianten mit 3 und 6 LEDs sowie einen Einbaurahmen zur randlosen Integration in den Raum.

La famiglia Bento IP viene offerta con una scelta di 3 e 6 ottiche, insieme alla versione trimless, per assicurare la massima integrazione nello spazio.

Bento IP bietet mit IP65 ein Höchstmaß an Schutz. Dadurch kann die Leuchte auch in feuchten Räumen oder in Bereichen, die Staub und Wasser ausgesetzt sind, installiert werden.

Bento IP offre un grado di protezione Full IP65 che consente di installare l'apparecchio in spazi con umidità o esposti a polvere ed acqua.



BENTO LOW VOLTAGE



Bento Low Voltage vereint das Wesentliche der Bento-Kollektion, bietet einen ausgezeichneten Sehkomfort mithilfe des Dark-Light-Effekts und integriert sich vollends in die Flexibilität des Niederspannungssystems.

Bento Low Voltage riproduce la stessa essenza della collezione Bento, offrendo un eccellente controllo ottico e un effetto Dark Light, combinabile con tutta la flessibilità del sistema a bassa tensione.



BENTO

Bento Standard

BODY MAT
PC,AL



IP
23



WELL



14

60



14-14



60-60



14-60



60-14

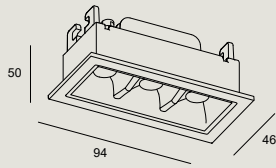

40x89



0-18 mm

LED Max. 700mA 9V

K	CRI	W LED	W Total	Real Lm	Optics	Code	
2700	90	6.1	6.1	449	Spot 18°	90-6364	
2700	90	6.1	6.1	467	Medium 34°	90-6366 - 14 - 14	
2700	90	6.1	6.1	421	Flood 49°	90-6368 - 60 - 60	
3000	90	6.1	6.1	449	Spot 18°	90-6365	
3000	90	6.1	6.1	467	Medium 34°	90-6367 - 14 - 14	
3000	90	6.1	6.1	421	Flood 49°	90-6369 - 60 - 60	
4000	90	6.1	6.1	494	Spot 18°	90-6673	
4000	90	6.1	6.1	514	Medium 34°	90-6674 - 14 - 14	
4000	90	6.1	6.1	463	Flood 49°	90-6675 - 60 - 60	
ON-OFF		DALI2/PUSH		1-10V/PUSH		PHASE CUT 240V	
71-6651		71-A190		71-7710		71-7663	
						CASAMBI	
						71-A261	

Der Treiber muss ausserhalb der Leuchte installiert werden / Il driver deve essere installato in remoto

BODY MAT
PC,AL



IP
23



WELL



14



14-14



14-60

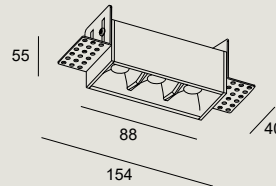

40x89



0-18 mm

LED Max. 700mA 9V

K	CRI	W LED	W Total	Real Lm	Optics	Code	
2700	90	6.1	6.1	449	Spot 18°	90-6161	
2700	90	6.1	6.1	467	Medium 34°	90-6163 - 14 - 14	
2700	90	6.1	6.1	421	Flood 49°	90-6165 - 60 - 60	
3000	90	6.1	6.1	449	Spot 18°	90-6162	
3000	90	6.1	6.1	467	Medium 34°	90-6164 - 14 - 14	
3000	90	6.1	6.1	421	Flood 49°	90-6166 - 60 - 60	
4000	90	6.1	6.1	494	Spot 18°	90-6676	
4000	90	6.1	6.1	514	Medium 34°	90-6677 - 14 - 14	
4000	90	6.1	6.1	463	Flood 49°	90-6678 - 60 - 60	
ON-OFF		DALI2/PUSH		1-10V/PUSH		PHASE CUT 240V	
71-6651		71-A190		71-7710		71-7663	
						CASAMBI	
						71-A261	

BENTO

Bento Standard

BODY MAT		IP		(SC)
PC,AL		23		

14 60

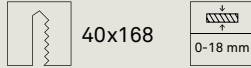
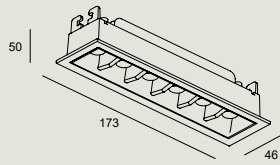

LED Max. 700mA 18V											
K	CRI	W LED	W Total	Real Lm	Optics	Code					
2700	90	12.2	12.2	993	Spot 18°	90-6370	14	-	14		
2700	90	12.2	12.2	927	Medium 34°	90-6372	60	-	60		
2700	90	12.2	12.2	882	Flood 48°	90-6374	60	-	60		
3000	90	12.2	12.2	993	Spot 18°	90-6371	14	-	14		
3000	90	12.2	12.2	927	Medium 34°	90-6373	60	-	60		
3000	90	12.2	12.2	882	Flood 48°	90-6375	60	-	60		
4000	90	12.2	12.2	1093	Spot 18°	90-6679	14	-	14		
4000	90	12.2	12.2	1020	Medium 34°	90-6680	60	-	60		
4000	90	12.2	12.2	970	Flood 48°	90-6681	60	-	60		
	ON-OFF		1-10V/PUSH		DALI/DALI2		PHASE CUT 240V		DALI D4i (SC)		CASAMBI (S)
71-6658		71-7710		71-6192		71-6430		71-7737		71-A260	

BODY MAT		IP	UGR	LOW				WELL	(SC)
AL		23	<16	FLICKER					

14 60

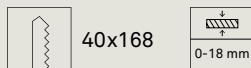
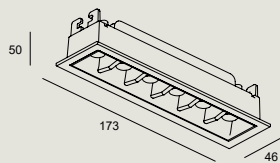

LED									
K	CRI	W LED	W Total	Real Lm	Optics	Code			
TW 2700-6500	90	12,6	15	1169	Medium 38°	90-7804	14	-	TW
TW 2700-6500	90	12,6	15	1042	Flood 48°	90-7805	60	-	TW
	220-240V	50-60Hz							

Smart Compatible-Zub. / Access. Smart Compatible
71-5961-00-00 Dimmer DALI Casambi

BENTO

Bento Standard

BODY MAT
PC,AL



IP
23



WELL



14



14-14

14-60

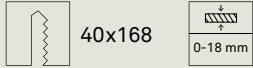
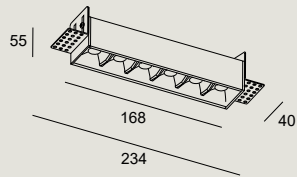

LED Max. 700mA 18V											
K	CRI	W LED	W Total	Real Lm	Optics	Code					
2700	90	12.2	12.2	993	Spot 18°	90-6167					
2700	90	12.2	12.2	927	Medium 34°	90-6169	14 - 14 - 60				
2700	90	12.2	12.2	882	Flood 48°	90-6171					
3000	90	12.2	12.2	993	Spot 18°	90-6168					
3000	90	12.2	12.2	927	Medium 34°	90-6170	14 - 14 - 60				
3000	90	12.2	12.2	882	Flood 48°	90-6172					
4000	90	12.2	12.2	1093	Spot 18°	90-6682					
4000	90	12.2	12.2	1020	Medium 34°	90-6683	14 - 14 - 60				
4000	90	12.2	12.2	970	Flood 48°	90-6684					
	ON-OFF		1-10V/PUSH		DALI/DALI2		PHASE CUT 240V		DALI D4i (SC)		CASAMBI (S)
71-6658		71-7710		71-6192		71-6430		71-7737		71-A260	

BODY MAT
PC,AL



IP
23



WELL



14

60



14-14

60-60

14-60

60-14

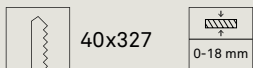
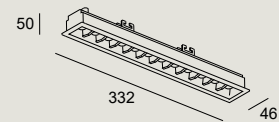

LED Max. 700mA 36V											
K	CRI	W LED	W Total	Real Lm	Optics	Code					
2700	90	24.4	24.4	1744	Spot 19°	90-6376					
2700	90	24.4	24.4	1715	Medium 35°	90-6378	14 - 60 - 60				
2700	90	24.4	24.4	1622	Flood 49°	90-6380					
3000	90	24.4	24.4	1744	Spot 19°	90-6377					
3000	90	24.4	24.4	1715	Medium 35°	90-6379	14 - 60 - 60				
3000	90	24.4	24.4	1622	Flood 49°	90-6381					
4000	90	24.4	24.4	1918	Spot 19°	90-6685					
4000	90	24.4	24.4	1887	Medium 35°	90-6686	14 - 60 - 60				
4000	90	24.4	24.4	1784	Flood 49°	90-6687					
	ON-OFF		1-10V/PUSH		CASAMBI (S)		DALI2/PUSH		DALI D4i (SC)		PHASE CUT 240V
71-6653		71-4708		71-A260		71-A192		71-7737		71-A299	

BENTO

Bento Standard

BODY MAT
PC,AL



IP
20



WELL



14

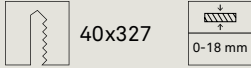
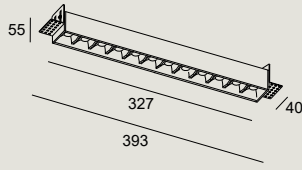

LED max. 700mA									
K	CRI	W LED	W Total	Real Lm	Optics	Code			
4000	90	24.4	24.4	1918	Spot 19°	90-6688			
4000	90	24.4	24.4	1887	Medium 35°	90-6689 - 14 - 60			
4000	90	24.4	24.4	1784	Flood 49°	90-6690			
	ON-OFF		1-10V/PUSH		CASAMBI		DALI2/PUSH		PHASE CUT 240V
71-6653		71-4708		71-A260		71-A192		71-A299	

BODY MAT
PC,AL



IP
23



WELL



14

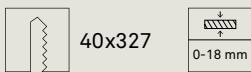
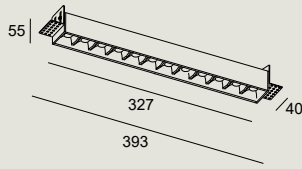

LED Max. 700mA 36V											
K	CRI	W LED	W Total	Real Lm	Optics	Code					
2700	90	24.4	24.4	1744	Spot 19°	90-6173					
2700	90	24.4	24.4	1715	Medium 35°	90-6175 - 14 - 60					
2700	90	24.4	24.4	1622	Flood 49°	90-6350					
3000	90	24.4	24.4	1744	Spot 19°	90-6174					
3000	90	24.4	24.4	1715	Medium 35°	90-6349 - 14 - 60					
3000	90	24.4	24.4	1622	Flood 49°	90-6351					
4000	90	24.4	24.4	1918	Spot 19°	90-6688					
4000	90	24.4	24.4	1887	Medium 35°	90-6689 - 14 - 60					
4000	90	24.4	24.4	1784	Flood 49°	90-6690					
	ON-OFF		1-10V/PUSH		CASAMBI		DALI2/PUSH		DALI D4i		PHASE CUT 240V
71-6653		71-4708		71-A260		71-A192		71-7737		71-A299	

BENTO

Bento Standard

BODY MAT		IP		WELL
PC,AL		23		

14 60



14-14

60-60

14-60

60-14

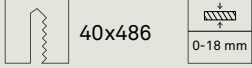
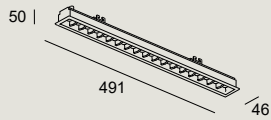

LED Max. 700mA 54V										
K	CRI	W LED	W Total	Real Lm	Optics	Code				
2700	90	36.5	36.5	2596	Spot 19°	90-6382	14	14		
2700	90	36.5	36.5	2590	Medium 36°	90-6384	60	60		
2700	90	36.5	36.5	2467	Flood 49°	90-6386				
3000	90	36.5	36.5	2596	Spot 19°	90-6383	14	14		
3000	90	36.5	36.5	2590	Medium 36°	90-6385	60	60		
3000	90	36.5	36.5	2467	Flood 49°	90-6387				
4000	90	36.5	36.5	2853	Spot 19°	90-6691	14	14		
4000	90	36.5	36.5	2846	Medium 36°	90-6692	60	60		
4000	90	36.5	36.5	2712	Flood 49°	90-6693				
ON-OFF			PHASE CUT 240V			1-10V/PUSH		DALI2/NA/PUSH		
71-4887			71-6431			71-4708		71-A303		

BODY MAT		IP		WELL
PC,AL		20		

14



14-14

14-60

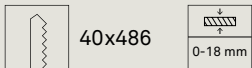
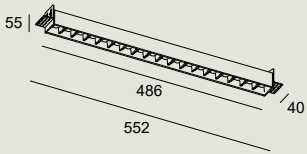

LED max. 700mA										
K	CRI	W LED	W Total	Real Lm	Optics	Code				
4000	90	36.5	36.5	2853	Spot 19°	90-6694	14	14		
4000	90	36.5	36.5	2846	Medium 36°	90-6695	60	60		
4000	90	36.5	36.5	2712	Flood 49°	90-6696				
ON-OFF			PHASE CUT 240V			1-10V/PUSH		DALI2/NA/PUSH		
71-4887			71-6431			71-4708		71-A303		

BENTO

Bento Standard

BODY MAT		IP	
PC,AL		23	

14

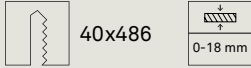
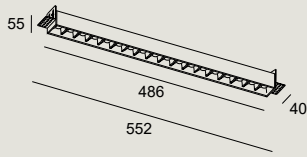

40x486



LED Max. 700mA 54V						
K	CRI	W LED	W Total	Real Lm	Optics	Code
2700	90	36.5	36.5	2596	Spot 19°	90-6352
2700	90	36.5	36.5	2590	Medium 36°	90-6354 - 14 - 14
2700	90	36.5	36.5	2467	Flood 49°	90-6356 - 60
3000	90	36.5	36.5	2596	Spot 19°	90-6353
3000	90	36.5	36.5	2590	Medium 36°	90-6355 - 14 - 14
3000	90	36.5	36.5	2467	Flood 49°	90-6357 - 60

ON-OFF	PHASE CUT 240V	1-10V/PUSH	DALI2/NA/PUSH
71-4887	71-6431	71-4708	71-A303

BODY MAT		IP		
PC,AL		23		

14 60

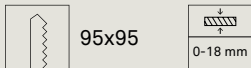
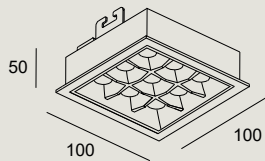

95x95



LED Max. 700mA 27V						
K	CRI	W LED	W Total	Real Lm	Optics	Code
2700	90	18.3	18.3	1361	Spot 18°	90-6388
2700	90	18.3	18.3	1378	Medium 34°	90-6390 - 14 - 14
2700	90	18.3	18.3	1303	Flood 48°	90-6392 - 60 - 60
3000	90	18.3	18.3	1361	Spot 18°	90-6389
3000	90	18.3	18.3	1378	Medium 34°	90-6391 - 14 - 14
3000	90	18.3	18.3	1303	Flood 48°	90-6393 - 60 - 60
4000	90	18.3	18.3	1495	Spot 18°	90-6697
4000	90	18.3	18.3	1514	Medium 34°	90-6698 - 14 - 14
4000	90	18.3	18.3	1432	Flood 48°	90-6699 - 60 - 60

ON-OFF	CASAMBI (S)	DALI D4i (SC)	DALI2/PUSH	1-10V/PUSH	PHASE CUT 240V
71-6658	71-A260	71-7737	71-A192	71-7710	71-A299

BENTO

Bento Standard

BODY MAT
PC,AL



IP
20



WELL



14

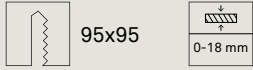
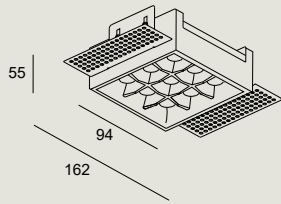

LED max. 700mA						
K	CRI	W LED	W Total	Real Lm	Optics	Code
4000	90	18.3	18.3	1495	Spot 18°	90-7002
4000	90	18.3	18.3	1514	Medium 34°	90-7005 - 14 - 60
4000	90	18.3	18.3	1432	Flood 48°	90-7006
ON-OFF	CASAMBI	DALI D4i	DALI2/PUSH	1-10V/PUSH	PHASE CUT 240V	
71-6658	71-A260	71-7737	71-A192	71-7710	71-A299	

BODY MAT
PC,AL



IP
23



WELL



14

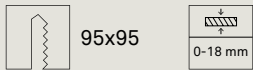
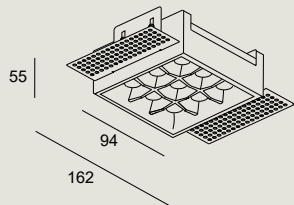



LED Max. 700mA 27V						
K	CRI	W LED	W Total	Real Lm	Optics	Code
2700	90	18.3	18.3	1361	Spot 18°	90-6358
2700	90	18.3	18.3	1378	Medium 34°	90-6360 - 14 - 60
2700	90	18.3	18.3	1303	Flood 48°	90-6362
3000	90	18.3	18.3	1361	Spot 18°	90-6359
3000	90	18.3	18.3	1378	Medium 34°	90-6361 - 14 - 60
3000	90	18.3	18.3	1303	Flood 48°	90-6363
ON-OFF	CASAMBI	DALI D4i	DALI2/PUSH	1-10V/PUSH	PHASE CUT 240V	
71-6658	71-A260	71-7737	71-A192	71-7710	71-A299	

BENTO

Bento Standard Emergency



BODY MAT		IP	UGR		WELL
PC,AL		23	<10		

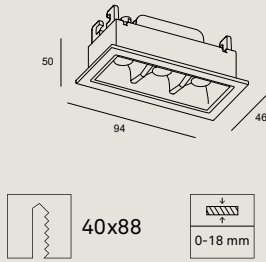

14  60 



LED K:2700 CRI:90 BATTERY:NiCd								
W	Real Lm	Real Lm. Em	Optics	H. emergency	Perma- nent	Auto test	Code	
6.1	449	106	Spot 18°	3	Yes	No	90-6364	14 - DE
6.1	467	110	Medium 34°	3	Yes	No	90-6366	60 - OE
6.1	421	100	Flood 49°	3	Yes	No	90-6368	

DE	DALI	220-240V	50-60Hz
OE	ON-OFF	220-240V	50-60Hz



BODY MAT		IP	UGR		WELL
PC,AL		23	<10		

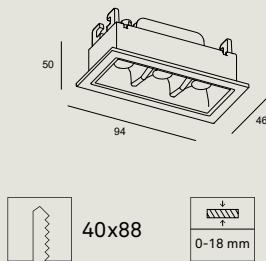

14  60 



LED K:3000 CRI:90 BATTERY:NiCd								
W	Real Lm	Real Lm. Em	Optics	H. emergency	Perma- nent	Auto test	Code	
6.1	449	106	Spot 18°	3	Yes	No	90-6365	14 - DE
6.1	467	110	Medium 34°	3	Yes	No	90-6367	60 - OE
6.1	421	100	Flood 49°	3	Yes	No	90-6369	

DE	DALI	220-240V	50-60Hz
OE	ON-OFF	220-240V	50-60Hz

BODY MAT		IP		WELL
PC,AL		23		

14  60 

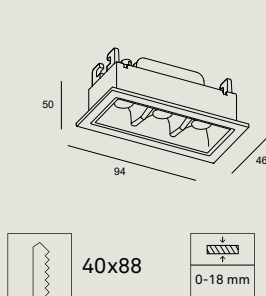





LED K:4000 CRI:90 BATTERY:NiCd								
W	Real Lm	Real Lm. Em	Optics	H. emergency	Perma- nent	Auto test	Code	
6.1	494	117	Spot 18°	3	Yes	No	90-6673	14 - DE
6.1	514	122	Medium 34°	3	Yes	No	90-6674	60 - OE
6.1	463	110	Flood 49°	3	Yes	No	90-6675	

DE	DALI	220-240V	50-60Hz
OE	ON-OFF	220-240V	50-60Hz

BENTO

Bento Standard Emergency

BODY MAT		IP		WELL
PC,AL		23		



14  60 



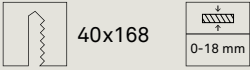
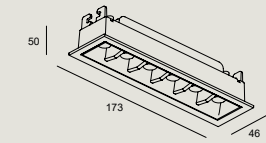

14-14 60-60



LED K:4000 CRI:90 BATTERY:NiCd								
W	Real Lm	Real Lm. Em	Optics	H. emergency	Perma- nent	Auto test	Code	
12.2	1093	129	Medium 34°	3	Yes	No	90-6679	
12.2	1020	121	Medium 34°	3	Yes	No	90-6680 - 14 - DE	
12.2	970	115	Flood 48°	3	Yes	No	90-6681 - 60 - OE	
								
DE	DALI	220-240V	50-60Hz					
OE	ON-OFF	220-240V	50-60Hz					

BODY MAT		IP		WELL
PC,AL		23		



14  60 



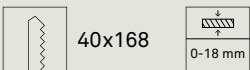
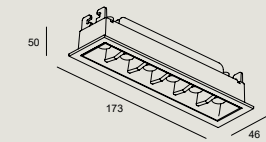

14-14 60-60



LED K:2700 CRI:90 BATTERY:NiCd								
W	Real Lm	Real Lm. Em	Optics	H. emergency	Perma- nent	Auto test	Code	
12.2	993	117	Medium 34°	3	Yes	No	90-6370	
12.2	927	110	Medium 34°	3	Yes	No	90-6372 - 14 - DE	
12.2	882	104	Flood 48°	3	Yes	No	90-6374 - 60 - OE	
								
DE	DALI	220-240V	50-60Hz					
OE	ON-OFF	220-240V	50-60Hz					

BODY MAT		IP		WELL
PC,AL		23		

14  60 



14-14 60-60

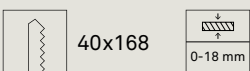
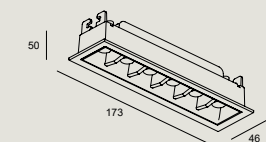

LED K:3000 CRI:90 BATTERY:NiCd								
W	Real Lm	Real Lm. Em	Optics	H. emergency	Perma- nent	Auto test	Code	
12.2	993	117	Medium 34°	3	Yes	No	90-6371	
12.2	927	110	Medium 34°	3	Yes	No	90-6373 - 14 - DE	
12.2	882	104	Flood 48°	3	Yes	No	90-6375 - 60 - OE	
								
DE	DALI	220-240V	50-60Hz					
OE	ON-OFF	220-240V	50-60Hz					

BENTO

Bento Adjustable

BODY MAT		IP			WELL	
AL		23	40°			

14 60

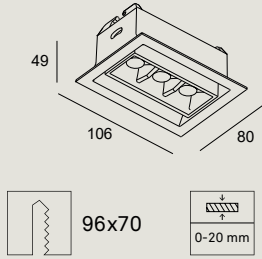

LED Max. 700mA 9V									
K	CRI	W LED	W Total	Real Lm	Optics	Code			
2700	90	6.1	6.1	449	Spot 18°	90-7098	14	-	14
2700	90	6.1	6.1	467	Medium 34°	90-7099	60	-	60
2700	90	6.1	6.1	421	Flood 49°	90-7100	60	-	60
3000	90	6.1	6.1	449	Spot 18°	90-7101	14	-	14
3000	90	6.1	6.1	467	Medium 34°	90-7161	60	-	60
3000	90	6.1	6.1	421	Flood 49°	90-7169	60	-	60
4000	90	6.1	6.1	494	Spot 18°	90-7184	14	-	14
4000	90	6.1	6.1	514	Medium 34°	90-7185	60	-	60
4000	90	6.1	6.1	463	Flood 49°	90-7186	60	-	60
71-6651		71-A190		71-7710		71-7663		71-A261	

BODY MAT		IP			WELL	
AL		23	40°			

14 60

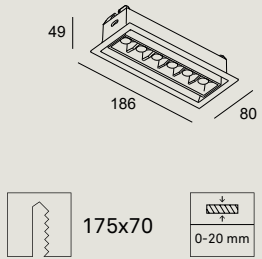

LED Max. 700mA 18V									
K	CRI	W LED	W Total	Real Lm	Optics	Code			
2700	90	12.2	12.2	904	Spot 18°	90-7187	14	-	14
2700	90	12.2	12.2	844	Medium 34°	90-7188	60	-	60
2700	90	12.2	12.2	802	Flood 48°	90-7189	60	-	60
3000	90	12.2	12.2	904	Spot 18°	90-7190	14	-	14
3000	90	12.2	12.2	844	Medium 34°	90-7191	60	-	60
3000	90	12.2	12.2	802	Flood 48°	90-7192	60	-	60
4000	90	12.2	12.2	993	Spot 18°	90-7193	14	-	14
4000	90	12.2	12.2	927	Medium 34°	90-7194	60	-	60
4000	90	12.2	12.2	882	Flood 48°	90-7195	60	-	60
71-6658		71-7710		71-6192		71-6430		71-7737	
								71-A260	

INDOOR DOWNLIGHTS / DOWNLIGHTS

BENTO

Bento Surface

BODY MAT		IP	WELL	
AL		23		

14 60

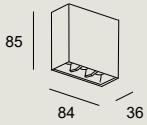

LED Max. 700mA 9V						
K	CRI	W LED	W Total	Real Lm	Optics	Code
2700	90	6.1	6.1	449	Spot 18°	15-7098
2700	90	6.1	6.1	467	Medium 34°	15-7099 - 14 - 60
2700	90	6.1	6.1	421	Flood 49°	15-7100 - 60 - 60
3000	90	6.1	6.1	449	Spot 18°	15-7101
3000	90	6.1	6.1	467	Medium 34°	15-7161 - 14 - 60
3000	90	6.1	6.1	421	Flood 49°	15-7169 - 60 - 60
4000	90	6.1	6.1	494	Spot 18°	15-7184
4000	90	6.1	6.1	514	Medium 34°	15-7185 - 14 - 60
4000	90	6.1	6.1	463	Flood 49°	15-7186 - 60 - 60
ON-OFF		DALI2/PUSH		1-10V/PUSH		PHASE CUT 240V
71-6651		71-A190		71-7710		71-7663
						CASAMBI
						71-A261

BODY MAT		IP		WELL
AL		23		

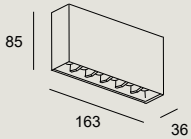
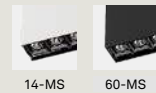

14 60





LED						
K	CRI	W LED	W Total	Real Lm	Optics	Code
2700	90	12.2	14.7	904	Spot 18°	15-7187
2700	90	12.2	14.7	844	Medium 34°	15-7188 - 14 - MS
2700	90	12.2	14.7	802	Flood 48°	15-7189 - 60 - MS
3000	90	12.2	14.7	904	Spot 18°	15-7190
3000	90	12.2	14.7	844	Medium 34°	15-7191 - 14 - MS
3000	90	12.2	14.7	802	Flood 48°	15-7192 - 60 - MS
4000	90	12.2	14.7	993	Spot 18°	15-7193
4000	90	12.2	14.7	927	Medium 34°	15-7194 - 14 - MS
4000	90	12.2	14.7	882	Flood 48°	15-7195 - 60 - MS
220-240V		50-60Hz				

BENTO

Bento Surface

BODY MAT		IP		WELL
AL		23	PHASE CUT	

14  60 

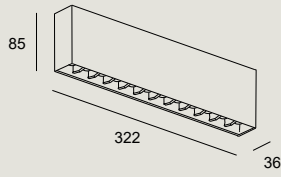
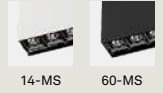

LED						
K	CRI	W LED	W Total	Real Lm	Optics	Code
2700	90	24.4	25.7	1744	Spot 19°	15-7196
2700	90	24.4	25.7	1715	Medium 35°	15-7197 - 14 - MS
2700	90	24.4	25.7	1622	Flood 49°	15-7198 - 60 - MS
3000	90	24.4	25.7	1744	Spot 19°	15-7199
3000	90	24.4	25.7	1715	Medium 35°	15-7200 - 14 - MS
3000	90	24.4	25.7	1622	Flood 49°	15-7201 - 60 - MS
4000	90	24.4	25.7	1918	Spot 19°	15-7202
4000	90	24.4	25.7	1887	Medium 35°	15-7203 - 14 - MS
4000	90	24.4	25.7	1784	Flood 49°	15-7204 - 60 - MS
 220-240V		50-60Hz				

BENTO

Bento IP

BODY MAT
PC,AL,GLA

DIF MAT
GLA



IP
65



BREEAM

WELL



14



14-60

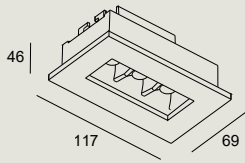

59x107



LED Max. 700mA 9V

K	CRI	W LED	W Total	Real Lm	Optics	Code			
2700	90	6.1	6.1	444	Spot 18°	90-7214			
2700	90	6.1	6.1	437	Medium 31°	90-7215 - 14 - 60			
2700	90	6.1	6.1	402	Flood 49°	90-7216			
3000	90	6.1	6.1	444	Spot 18°	90-7217			
3000	90	6.1	6.1	437	Medium 31°	90-7218 - 14 - 60			
3000	90	6.1	6.1	402	Flood 49°	90-7219			
4000	90	6.1	6.1	488	Spot 18°	90-7220			
4000	90	6.1	6.1	480	Medium 31°	90-7221 - 14 - 60			
4000	90	6.1	6.1	442	Flood 49°	90-7222			
71-6651		71-A190		71-7710		71-7663		71-A261	

nicht inklusive / Non incluso

Installationsset ohne Rahmen
Kit installazione senza cornice

71-7522-14-00

BODY MAT
PC,AL,GLA

DIF MAT
GLA



IP
65



BREEAM

WELL



14



14-60

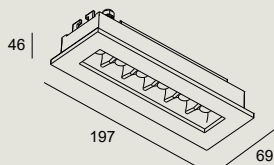

59x187



LED Max. 700mA 18V

K	CRI	W LED	W Total	Real Lm	Optics	Code					
2700	90	12.2	12.2	843	Spot 18°	90-7223					
2700	90	12.2	12.2	781	Medium 35°	90-7224 - 14 - 60					
2700	90	12.2	12.2	753	Flood 49°	90-7225					
3000	90	12.2	12.2	843	Spot 18°	90-7226					
3000	90	12.2	12.2	781	Medium 35°	90-7227 - 14 - 60					
3000	90	12.2	12.2	753	Flood 49°	90-7228					
4000	90	12.2	12.2	926	Spot 18°	90-7229					
4000	90	12.2	12.2	858	Medium 35°	90-7230 - 14 - 60					
4000	90	12.2	12.2	828	Flood 49°	90-7231					
71-6658		71-7710		71-6192		71-6430		71-7737		71-A260	

nicht inklusive / Non incluso

Installationsset ohne Rahmen
Kit installazione senza cornice

71-7523-14-00

BENTO

Bento Low Voltage

BODY MAT
PC,AL



UGR
<10



14

60

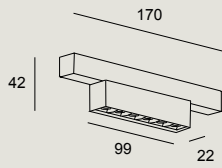

LED									
K	CRI	W LED	W Total	Real Lm	Optics	Code			
2700	90	6	8.1	594	Medium 26°	15-7885	- 14	-	00
2700	90	6	8.1	521	Flood 52°	15-A041	- 60	-	DA XB
3000	90	6	8.1	594	Medium 26°	15-7886	- 14	-	00
3000	90	6	8.1	521	Flood 52°	15-A042	- 60	-	DA XB

00 ON-OFF
DA DALI
XB CASAMBI
 48 VDC

Smart Compatible-Zub. / Access. Smart Compatibile
71-8115-00-00 Converter Casambi DALI Low Voltage

BODY MAT
PC,AL



UGR
<10



14

60

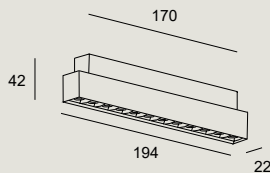

LED									
K	CRI	W LED	W Total	Real Lm	Optics	Code			
2700	90	12	13.5	1082	Medium 28°	15-7888	- 14	-	00
2700	90	12	13.5	1025	Flood 51°	15-A043	- 60	-	DA XB
3000	90	12	13.5	1082	Medium 28°	15-7889	- 14	-	00
3000	90	12	13.5	1025	Flood 51°	15-A044	- 60	-	DA XB

00 ON-OFF
DA DALI
XB CASAMBI
 48 VDC

Smart Compatible-Zub. / Access. Smart Compatibile
71-8115-00-00 Converter Casambi DALI Low Voltage



Luno

Recessed

P. 272



400 mm



600 mm



900 mm



1200 mm

24,5 W - 146 W

14 ○ 60 ● DL ●

Surface

P. 274



400 mm



600 mm



900 mm



1200 mm

24,5 W - 146 W

14 ○ 60 ● DL ●



Pendant

P. 278



400 mm



600 mm



900 mm



1200 mm

24,5 W - 146 W

14 ○ 60 ● DL ●

LUNO

BODY MAT		50000h	3	IP
AL		L80 B20	MacAdam	20



Verschiedene Optionen Diverse opzioni

Luno ist eine Kollektion von Flächenleuchten mit zylindrischen Formen und klarer Linienführung. Sie ist in verschiedenen Installations- und Größenvarianten erhältlich und bietet somit eine Vielzahl von Möglichkeiten für die Beleuchtung großer Räume wie Hörsäle, Konferenzräume, Restaurants oder Hotellobbys.

Luno è una collezione di downlights con forma cilindrica e con linee pure. Esistono diverse versioni di installazione e misure, che si traducono in una moltitudine di possibilità di illuminazione di grandi spazi come auditorium, sale conferenze, ristoranti o hall di hotel.

Luno ist als Auf- oder Unterputzversion sowie als Pendelleuchte in vier verschiedenen Durchmessern (400 mm, 600 mm, 900 mm und 1200 mm) erhältlich und wird somit jeder Anforderung gerecht.

Luno è disponibile in opzione superficie, incasso o sospensione, tutte in 4 diametri diversi (400mm, 600mm, 900mm e 1200 mm) per soddisfare qualsiasi esigenza.



Mikroprismatischen Diffusor Diffusore microprismatico

Die Surface-Version beinhaltet Modelle mit Opal-Diffusor für eine gleichmäßige Ausleuchtung sowie Modelle mit mikroprismatischen Diffusor, der für ein hohes Maß an Sehkomfort sorgt.

La versione Surface comprende modelli Opal, per un'illuminazione uniforme e con diffusore microprismatico, con un ottimo grado di comfort visivo.



Smart-Funktionen:
Zirkadianer Rhythmus
Funzionalità Smart:
Ciclo circadiano

Durch die Kombination von TW-Technologie und Leuchtensystem kann die Innenbeleuchtung so programmiert werden, dass sie je nach Standort der Anlage die natürliche Außenszene sehr präzise reproduziert und so zum Wohlbefinden der Menschen beiträgt und ihren Wach- und Schlafzyklus unterstützt.

Mediante il binomio sistema connettivo ed apparecchio TW, è possibile programmare l'illuminazione interna in modo da riprodurre in modo piuttosto preciso l'illuminazione naturale esterna, a seconda della posizione dell'impianto, aiutando il benessere delle persone e il loro ciclo di veglia e di sonno.



LUNO

Luno Recessed

DIF MAT	IP	UGR		WELL
PMMA	20	<22		

14  60  DL* 

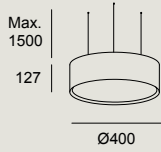

LED						
K	CRI	W LED	W Total	Real Lm	Code	
3000	80	24.5	26.8	2389	90-5922 - 14 - 60 - DL	OU RU
4000	80	24.5	26.8	2389	90-5923 - 14 - 60 - DL	OU RU

	OU ON-OFF	100-240V	50-60Hz
RU	1-10V	100-240V	50-60Hz

DIF MAT	IP	UGR		WELL
PMMA	20	<19		

14  60  DL* 

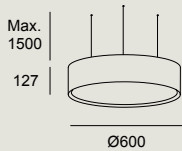

LED						
K	CRI	W LED	W Total	Real Lm	Code	
3000	80	52	60	5083	90-5924 - 14 - 60 - DL	OU RU
4000	80	52	60	5083	90-5925 - 14 - 60 - DL	OU RU

	OU ON-OFF	100-240V	50-60Hz
RU	1-10V	100-240V	50-60Hz

*Fragen Sie unser Verkaufsteam nach den Lieferbedingungen.

Consultare i termini e le condizioni di consegna al nostro team commerciale.

LUNO

Luno Recessed

DIF MAT	IP	UGR		WELL
PMMA	20	<19		

14 60 DL*

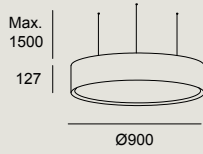

LED						
K	CRI	W LED	W Total	Real Lm	Code	
3000	80	97	105	9687	90-5926 - 14 - 60 - DL	OU RU
4000	80	97	105	9687	90-5927 - 14 - 60 - DL	OU RU

	OU ON-OFF	100-240V	50-60Hz
	RU 1-10V	100-240V	50-60Hz

DIF MAT	IP		WELL
PMMA	20		

14 60 DL*

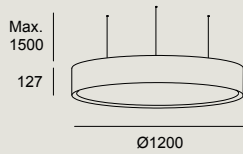

LED						
K	CRI	W LED	W Total	Real Lm	Code	
3000	80	146	156.1	15065	90-5928 - 14 - 60 - DL	OU RU
4000	80	146	156.1	15065	90-5929 - 14 - 60 - DL	OU RU

	OU ON-OFF	100-240V	50-60Hz
	RU 0-10V	100-240V	50-60Hz

*Fragen Sie unser Verkaufsteam nach den Lieferbedingungen.

Consultare i termini e le condizioni di consegna al nostro team commerciale.

LUNO

Luno Surface Opal

DIF MAT	IP	LOW	WELL	UGR	(SC)
PMMA	23	FLICKER		<22	

14 60

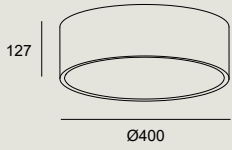

LED						
K	CRI	W LED	W Total	Real Lm	Code	
3000	80	24.5	27.5	2389	15-5922 - 14 - 60	DS
4000	80	24.5	27.5	2389	15-5923 - 14 - 60	DS
TW 2700-6500	90	22.4	28	1892	15-7842 - 14 - 60	TW

	DS	DALI	220-240V	50-60Hz
	TW	DALI DT8	220-240V	50-60Hz

DIF MAT	IP	UGR	LOW	WELL	(SC)
PMMA	23	<19	FLICKER		

14 60

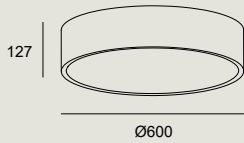

LED						
K	CRI	W LED	W Total	Real Lm	Code	
3000	80	52	59	5083	15-5924 - 14 - 60	DS
4000	80	52	59	5083	15-5925 - 14 - 60	DS
TW 2700-6500	90	47	55.3	4028	15-7843 - 14 - 60	TW

	DS	DALI	220-240V	50-60Hz
	TW	DALI DT8	220-240V	50-60Hz

LUNO

Luno Surface Low UGR Microprismatic

DIF MAT	IP	LOW	WELL	UGR	(SC)
PMMA, PLABS	23	FLICKER		<19	

14 60

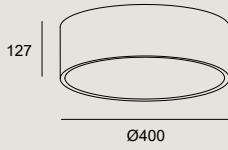

LED						
K	CRI	W LED	W Total	Real Lm	Code	
3000	80	24.5	27.5	2045	15-7806 - 14 - 60	DS
4000	80	24.5	27.5	2045	15-7807 - 14 - 60	DS
TW 2700-6500	90	22.4	28	1584	15-7810 - 14 - 60	TW

	DS	DALI	220-240V	50-60Hz
	TW	DALI DT8	220-240V	50-60Hz

DIF MAT	IP	LOW	WELL	UGR	(SC)
PMMA, PLABS	23	FLICKER		<19	

14 60

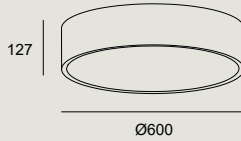



LED						
K	CRI	W LED	W Total	Real Lm	Code	
3000	80	52	59	4380	15-7808 - 14 - 60	DS
4000	80	52	59	4380	15-7809 - 14 - 60	DS
TW 2700-6500	90	47	55.3	4432	15-7811 - 14 - 60	TW

	DS	DALI	220-240V	50-60Hz
	TW	DALI DT8	220-240V	50-60Hz

LUNO

Luno Surface

DIF MAT	IP	UGR	WELL
PMMA	20	<22	

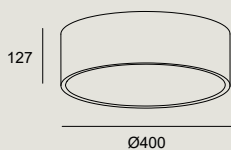

14  60  DL* 



LED						
K	CRI	W LED	W Total	Real Lm	Code	
3000	80	24.5	26.8	2389	15-5922 - 14 - 60 - DL	OU RU
4000	80	24.5	26.8	2389	15-5923 - 14 - 60 - DL	OU RU

	OU	ON-OFF	100-240V	50-60Hz
	RU	1-10V	100-240V	50-60Hz

DIF MAT	IP	UGR	WELL
PMMA	20	<19	

14  60  DL* 

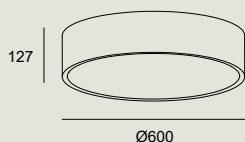

LED						
K	CRI	W LED	W Total	Real Lm	Code	
3000	80	52	60	5083	15-5924 - 14 - 60 - DL	OU RU
4000	80	52	60	5083	15-5925 - 14 - 60 - DL	OU RU

	OU	ON-OFF	100-240V	50-60Hz
	RU	1-10V	100-240V	50-60Hz

*Fragen Sie unser Verkaufsteam nach den Lieferbedingungen.

Consultare i termini e le condizioni di consegna al nostro team commerciale.

LUNO

Luno Surface

DIF MAT	IP	UGR	WELL
PMMA	20	<19	

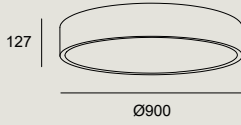

14  60  DL* 



LED						
K	CRI	W LED	W Total	Real Lm	Code	
3000	80	97	105	9687	15-5926 - 14 - 60 - DL	OU RU
4000	80	97	105	9687	15-5927 - 14 - 60 - DL	OU RU

	OU ON-OFF	100-240V	50-60Hz
	RU 1-10V	100-240V	50-60Hz

DIF MAT	IP	WELL	UGR
PMMA	20		<22

14  60  DL* 

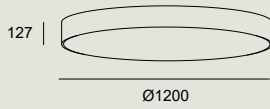

LED						
K	CRI	W LED	W Total	Real Lm	Code	
3000	80	146	156.1	15065	15-5928 - 14 - 60 - DL	OU RU
4000	80	146	156.1	15065	15-5929 - 14 - 60 - DL	OU RU

	OU ON-OFF	100-240V	50-60Hz
	RU 0-10V	100-240V	50-60Hz



*Fragen Sie unser Verkaufsteam nach den Lieferbedingungen.

Consultare i termini e le condizioni di consegna al nostro team commerciale.

LUNO

Luno Pendant

DIF MAT	IP	UGR	WELL
PMMA	20	<22	

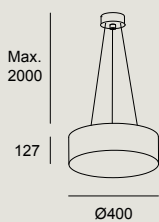

14  60  DL* 



LED						
K	CRI	W LED	W Total	Real Lm	Code	
3000	80	24.5	26.8	2389	00-5922 - 14 - 60 - DL	OU RU
4000	80	24.5	26.8	2389	00-5923 - 14 - 60 - DL	OU RU

	OU	ON-OFF	100-240V	50-60Hz
	RU	1-10V	100-240V	50-60Hz

DIF MAT	IP	UGR	WELL
PMMA	20	<19	

14  60  DL* 

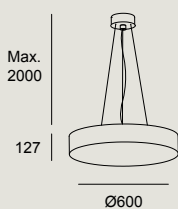

LED						
K	CRI	W LED	W Total	Real Lm	Code	
3000	80	52	60	5083	00-5924 - 14 - 60 - DL	OU RU
4000	80	52	60	5083	00-5925 - 14 - 60 - DL	OU RU

	OU	ON-OFF	100-240V	50-60Hz
	RU	1-10V	100-240V	50-60Hz

*Fragen Sie unser Verkaufsteam nach den Lieferbedingungen.

Consultare i termini e le condizioni di consegna al nostro team commerciale.

LUNO

Luno Pendant

DIF MAT	IP	UGR	WELL
PMMA	20	<19	

14  60  DL* 

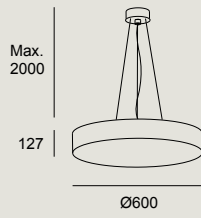

LED						
K	CRI	W LED	W Total	Real Lm	Code	
3000	80	97	105	9687	00-5926 - 14 - 60 - DL	OU RU
4000	80	97	105	9687	00-5927 - 14 - 60 - DL	OU RU

	OU ON-OFF	100-240V	50-60Hz
	RU 1-10V	100-240V	50-60Hz

DIF MAT	IP	UGR	WELL
PMMA	20	<22	

14  60  DL* 

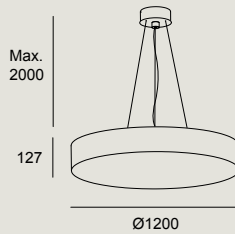

LED						
K	CRI	W LED	W Total	Real Lm	Code	
3000	80	146	156.1	15065	00-5928 - 14 - 60 - DL	OU RU
4000	80	146	156.1	15065	00-5929 - 14 - 60 - DL	OU RU

	OU ON-OFF	100-240V	50-60Hz
	RU 0-10V	100-240V	50-60Hz

*Fragen Sie unser Verkaufsteam nach den Lieferbedingungen.

Consultare i termini e le condizioni di consegna al nostro team commerciale.



Finelight

BODY MAT	DIF MAT		50000h	3
AL	PVC		L80 B20	MacAdam



**Komfortable und anpassbare
Beleuchtung**
Illuminazione confortevole e
adattabile

Finelight ist eine technische Leuchte, die große Räume gleichmäßig, sanft und angenehm ausleuchten kann und hohen Komfort bietet. Ihr klares Design ermöglicht eine vollkommene Integration in die Decke und ist für die Beleuchtung unterschiedlicher Umgebungen in Büros, Arbeitsbereichen oder Hörsälen konzipiert. Sie zeichnet sich unter anderem durch ihre hohe Effizienz mit einem hohen lm/W-Wert und ihre Kompatibilität mit Decken mit sichtbaren, verborgenen oder halbverborgenen Profilen aus (die beiden letzteren mithilfe von Installationszubehör).

Finelight è un apparecchio tecnico, concepito per illuminare spazi ampi in modo uniforme e con un alto grado di comfort, dotandoli di una luce morbida e gradevole. Dotato di un design pulito per una perfetta integrazione a soffitto, è stato ideato per illuminare diversi ambienti in uffici, aree di lavoro o auditorium. Si distingue per la sua grande efficienza con un elevato lm/w e la sua compatibilità con le plafoniere a profilo visto, nascosto o seminascosto (questi ultimi due con accessorio di installazione).

Das opale Diffusorsystem und die Blendschutzlamellen (I-shape, single parabolic) schaffen eine komfortable Beleuchtungslösung, die an den Menschen und den Raum angepasst werden kann.

L'insieme di diffusore opalizzato e le lamelle antisdrucchiolevoli (I-shape, single parabolic) generano una soluzione di illuminazione confortevole ed adattabile alle persone e agli spazi.

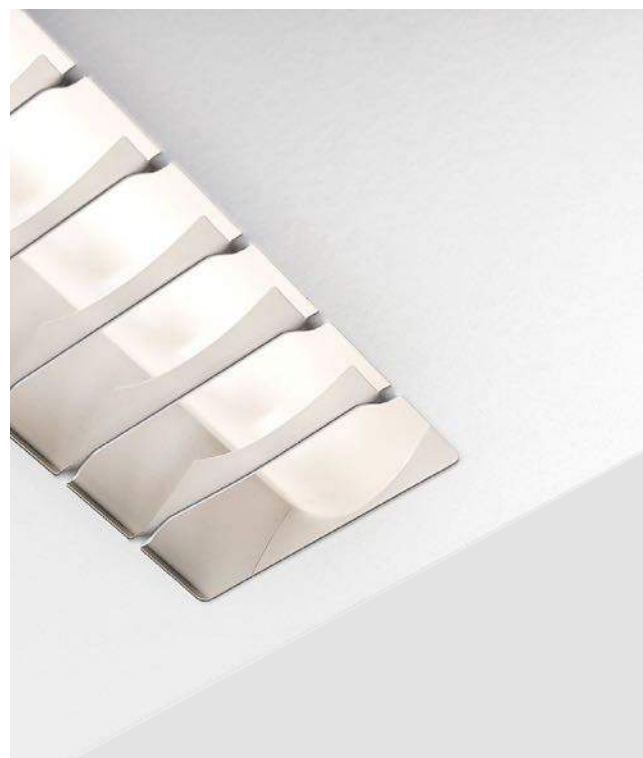

Tunable white

Finelight wurde mit dem Ziel entwickelt, ein ausgewogenes Verhältnis zwischen Effizienz und Wohlbefinden zu bieten. Die Leuchte wird in Tunable White-Ausführungen angeboten, welche eine Anpassung der Farbtemperatur an räumliche oder menschliche Anforderungen ermöglicht und so dazu beiträgt, den natürlichen Biorhythmus in Umgebungen mit wenig Tageslicht nachzubilden.

Finelight è appositamente progettata per offrire un equilibrio tra efficienza e benessere. È per questo che incorpora versioni Tunable White che permettono di adattare la temperatura di colore alle esigenze dell'installazione o delle persone, contribuendo a ripristinare i bioritmi naturali in ambienti a bassa luce naturale.



Smart

Dank des eingebauten D4i-Konnektivsensors verfügt Finelight über die D4i-Technologie, welche die Überwachung von Temperatur, Helligkeit, Belegung sowie Verbrauch ermöglicht und eine Bluetooth-Verbindung bietet. Kompatibel mit der Lösung Smart Light for Office.

Finelight è dotato di tecnologia D4i incorporata, grazie all'integrazione del Sensore Connettivo D4i che permette il monitoraggio di temperatura, luminosità, occupazione, consumo e segnale bluetooth. Compatibile con la soluzione Smart Light for Office.



Smart-Funktionen Funzionalità Smart

Finelight ist in D4i-Versionen erhältlich, die neben anderen Eigenschaften eine Maximierung der Energieeffizienz ermöglichen, da der vernetzte Mehrfachsensordie Steuerung und Dimmung der Beleuchtung in Abhängigkeit von anwesenden Personen und des von außen einfallenden Tageslichts ermöglicht sowie den Verbrauch der Leuchte in Echtzeit meldet. So kann der Verbrauch der Anlage und die damit verbundene Energieeinsparung exakt ermittelt werden.

Finelight dispone di versioni D4i che permettono, tra altre funzionalità, di massimizzare l'efficienza energetica, in quanto il Multisensore connettivo permette di controllare e regolare l'illuminazione in funzione della presenza e della luminosità provenienti dall'esterno, oltre a segnalare in tempo reale il consumo dell'apparecchio. Permette di conoscere, in modo dettagliato, il consumo dell'impianto e il risparmio energetico che ne deriva.



FINELIGHT

UGR	IP	LOW		WELL	(SC)
<19	20	FLICKER			

14

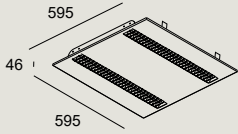

LED						
K	CRI	W LED	W Total	Real Lm	Code	
4000	80	35	38.2	3452	90-7835 - 14 - DS	
4000	80	35	38.2	3452	90-7836 - 14 - OS	
4000	80	35	38.2	3452	90-8105 - 14 - WR	

	DS	DALI	220-240V	50-60Hz		
	OS	ON-OFF	220-240V	50-60Hz		
	WR	DALI D4i	220-240V	50-60Hz		

nicht inklusive / Non incluso

Installation mit verborgenem/halbverborgenem Profil 71-7841-00-00
 Installazione in profilo nascosto/seminascosto

Smart Compatible-Zub. / Access. Smart Compatibile

71-5961-00-00 Dimmer DALI Casambi
 71-8056-00-00 Multisensor Connected D4i

UGR	LOW			WELL	(SC)	
<16	FLICKER		DALI DT8			

14

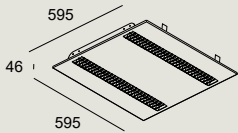

LED OSRAM						
K	CRI	W LED	W Total	Real Lm	Code	
TW 2700-6500	80	31.2	34.5	3165	90-7839 - 14 - TW	

	220-240V	50-60Hz				
--	----------	---------	--	--	--	--

Smart Compatible-Zub. / Access. Smart Compatibile

71-5961-00-00 Dimmer DALI Casambi

UGR	LOW				WELL	((S))
<19	FLICKER			DALI D4i		

14

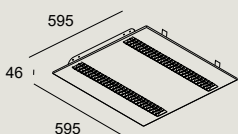

LED						
K	CRI	W LED	W Total	Real Lm	Code	
4000	80	35	37,3	3452	90-7840 - 14 - WR	
4000	80	35	37,3	3452	90-A042 - 14 - WR	

	220-240V	50-60Hz				
--	----------	---------	--	--	--	--

FINELIGHT

IP	UGR		WELL	(SC)
20	<19			

14

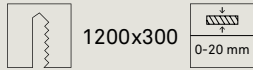
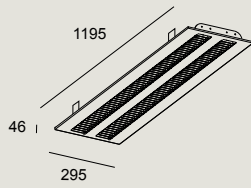

LED					
K	CRI	W LED	W Total	Real Lm	Code
4000	80	35	38.2	3459	90-8001 - 14 - DS
4000	80	35	38.2	3459	90-8002 - 14 - OS



DS	DALI	220-240V	50-60Hz
OS	ON-OFF	220-240V	50-60Hz

nicht inklusive / Non incluso

Installation mit verborgenem/halbverborgenem Profil
 Installazione in profilo nascosto/seminascosto

71-7841-00-00

Smart Compatible-Zub. / Access. Smart Compatibile

71-5961-00-00 Dimmer DALI Casambi

IP	UGR		WELL	((S))
20	<19			

14

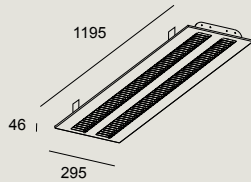

LED					
K	CRI	W LED	W Total	Real Lm	Code
4000	80	35	38.2	3459	90-8003 - 14 - WR
4000	80	35	38.2	3459	90-A043

220-240V 50-60Hz



Multidir Evo

BODY MAT	DIF MAT
AL	PC



Multidir Evo ist eine äußerst vielseitige kardanische Leuchtenkollektion, die in zwei Baugrößen erhältlich ist und in Auf- und Unterputzmontage für eine flexible und komfortable Beleuchtung mit einem oder zwei Modulen kombiniert werden kann. Die um $\pm 40^\circ$ schwenkbaren Leuchtelemente der Kollektion liefern einen hohen Lichtstrom und eine hervorragende Farbwiedergabe im Raum mit Leuchtmitteln bis zu CRI90. Damit sind sie die erste Wahl für die Beleuchtung in Einzelhandel und Gastronomie mit kompromissloser Lichtqualität.

Multidir Evo è una collezione cardanica molto versatile, disponibile in due misure, installabile in superficie o incassata, combinata con una o due moduli, per una grande flessibilità e comodità di illuminazione. Orientabile $\pm 40^\circ$, la collezione dispone di un elevato flusso luminoso e di un'alta riproduzione dei colori negli spazi e con soluzioni fino a CRI90, che la trasformano nella perfetta soluzione di illuminazione, con tutte le garanzie di qualità ambiente sia commerciale che per la ristorazione.

Neu konzipiertes System Sistema ridisegnato

Die Multidir Evo-Kollektion, die als Neuheit mit einem völlig neu konzipierten kardanischen System vorgestellt wird, ist in zahlreichen Modellvarianten als Auf- und Unterputzmodell mit einfacher oder doppelter Optik, trim oder trimless erhältlich. Alle Modelle bis auf die Unterputzvariante, die nur in Grau verfügbar ist, sind in Schwarz und Weiß erhältlich.

La collezione Multidir Evo, che si presenta come una novità, con un sistema cardanico completamente ridisegnato, è disponibile con diversi modelli nelle versioni da superficie e incassate, con un'ottica semplice, doppia, trim o trimless. Le finiture bianca e nera sono disponibili per tutti i modelli, mentre il grigio è fornito solo per la versione incassata.

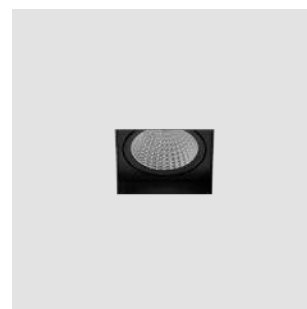

Flexible Ausrichtung Flessibilità di orientamento

Sowohl die LED-Ausführung als auch die GU10-Version mit auswechselbarem Leuchtmittel bieten eine Verstellbarkeit um $\pm 40^\circ$. Damit kann der Lichtstrahl zielgenau auf ein beliebiges Objekt gerichtet werden.

Tutto il sistema LED, così come il modulo intercambiabile con portalampada GU10, presentano una flessibilità di orientamento ($\pm 40^\circ$) che garantisce che il fascio di luce illumini sempre qualsiasi oggetto.



Visueller Komfort Comfort visivo

An sämtlichen Modellen kann ein Wabenpanel angebracht werden, mit dem der Lichtstrahl je nach den Anforderungen des Projekts moduliert werden kann und somit höheren Komfort bietet.

Tutti i modelli consentono l'installazione di un pannello a nido d'ape per modulare il fascio di luce in base alle necessità del progetto, aumentano il comfort.



Smart

Die Multidir Evo-Kollektion ist mit Bluetooth Mesh-Technologie Casambi ausgestattet, die eine genauere Steuerung der Leuchten und damit die Erzeugung verschiedener Lichtatmosphären in Umgebungen mit wechselnden Anforderungen ermöglicht.

La collezione Multidir Evo integra la tecnologia Casambi Bluetooth Mesh, che consente un maggiore controllo degli apparecchi e la possibilità di creare atmosfere luminose specifiche in ambienti con esigenze mutevoli.



INDOOR DOWNLIGHTS / DOWNLIGHTS

Smart-Funktionen: Lichtatmosphären Funzionalità Smart: Atmosfera luminosa

Als eine der möglichen Funktionen der Casambi-Technologie in Multidir Evo kann bei Bedarf eine Akzentbeleuchtung erzeugt werden, die die visuelle Aufmerksamkeit auf das Objekt lenkt und eine einzigartige Atmosphäre und Erfahrung schafft. Una delle funzionalità della tecnologia Casambi in Multidir Evo è quella di creare, quando necessario, un'illuminazione d'accento che concentri l'attenzione visiva sull'oggetto, creando un'atmosfera e un'esperienza unica.







MULTIDIR EVO

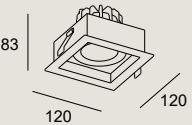

Multidir Small Single

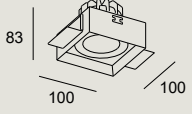
Codebeispiel / Esempio di codice: AU11-P8V9S3OS

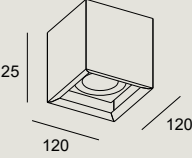
Model	W	K/ Cri/ Real lm	Optics	Source	Finishes	
 <p>AU11 - Einflaming / Einbau / Mit Rahmen Singolo / Incasso / Con Cornice 110x110 IP23</p> 	P8 7,3W	V9 2700K CRI90/863 lm	S3 18°	OS ON-OFF 220-240V/50-60Hz	60 ● 14 ○ NOT FOR AU12 34 ● NOT FOR AU12	
		W9 3000K CRI90/869 lm	M3 25°	DS DALI-2 110-277V/50-60Hz		
		X9 4000K CRI90/918 lm	F1 62°	BB 30V/Max.250mA		
	 <p>AU12 - Einflaming / Einbau / Ohne Rahmen Singolo / Incasso / Senza Cornice 100x100 IP23</p> 	11 10,7W	V9 2700K CRI90/1087 lm	S3 18°	OU ON-OFF 100-240V/50-60Hz	
			W9 3000K CRI90/1144 lm	M3 25°	DS DALI-2 110-277V/50-60Hz	
			X9 4000K CRI90/1160 lm	F1 62°	XB CASAMBI 220-240V/ 50-60Hz BB 30V/Max.350mA	
	 <p>AU15 - Einflaming / Aufbau Singolo / Superficie IP23</p> 	AA GU10	G1	NA	BU /100-240V/50-60Hz	

nicht inklusive / Non incluso

Wabenraster
Pannello a nido d'ape

71-A854-60-00

MULTIDIR EVO

Multidir Small Double



Codebeispiel / Esempio di codice: AU13-P8V9S3OS14

Model	W	K/ Cri/ Real lm	Optics	Source	Finishes
 <p>AU13 - Zweiflamming / Einbau / Mit Rahmen Doppio / Incasso / Con Cornice 208x110 IP23</p> 	P8 2 x 7,3W	V9 2700K CRI90/2 x 863 lm	S3 18°	OS ON-OFF 220-240V/50-60Hz	60 14 NOT FOR AU14 34 NOT FOR AU14
		W9 3000K CRI90/2 x 869 lm	M3 25°	DS DALI-2 110-277V/50-60Hz	
		X9 4000K CRI90/2 x 918 lm	F1 62°	BB 30V/Max.250mA	
	11 2 x 10,7W	V9 2700K CRI90/2 x 1087 lm	S3 18°	OU ON-OFF 100-240V/50-60Hz	
		W9 3000K CRI90/2 x 1144 lm	M3 25°	DS DALI-2 110-277V/50-60Hz	
		X9 4000K CRI90/2 x 1160 lm	F1 62°	XB CASAMBI 220-240V/ 50-60Hz BB 30V/Max.350mA	
AA 2x GU10	G1	NA	BU 100-240V/50-60Hz		
 <p>AU14 - Zweiflamming / Einbau / Ohne Rahmen Doppio / Incasso / Senza Cornice 200x100 IP23</p> 					
 <p>AU16 - Zweiflamming / Aufbau Doppio / Superficie IP23</p> 					

nicht inklusive / Non incluso

Wabenraster
Pannello a nido d'ape





71-A854-60-00

MULTIDIR EVO

Multidir Big Single

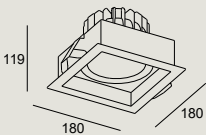

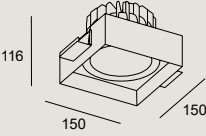
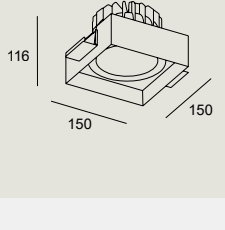
Codebeispiel / Esempio di codice: AU17-18V9S3OU14

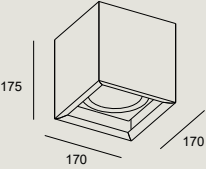
Model	W	K/ Cri/ Real lm	Optics	Source	Finishes
 AU17 - Einflamming / Einbau / Mit Rahmen Singolo / Incasso / Con Cornice 160x160 IP23 	18 16,6W	V9 2700K CRI90/1995 lm	S3 15°	OU ON-OFF 100-240V/50-60Hz	60 14 NOT FOR AU18 34 NOT FOR AU18
		W9 3000K CRI90/2010 lm	M3 23°	DS DALI-2 110-277V/50-60Hz	
		X9 4000K CRI90/2126 lm	F1 59°	XB CASAMBI 220-240V/ 50-60Hz BB 33V/Max. 500mA	
 AU18 - Einflamming / Einbau / Ohne Rahmen Singolo / Incasso / Senza Cornice 150x150 IP23 	33 30,3W	V9 2700K CRI90/3351 lm	S3 15°	OS ON-OFF 220-240V/50-60Hz	
		W9 3000K CRI90/3375 lm	M3 23°	DS DALI-2 110-277V/50-60Hz	
		X9 4000K CRI90/3571 lm	F1 59°	XB CASAMBI 220-240V/ 50-60Hz BB 33V/Max. 900mA	
 AU18 - Einflamming / Einbau / Ohne Rahmen Singolo / Incasso / Senza Cornice 150x150 IP23 	39 35,8W	V9 2700K CRI90/3850 lm	S3 15°	OU ON-OFF 100-240V/50-60Hz	
		W9 3000K CRI90/3878 lm	M3 23°	DS DALI-2 220-240V/50-60Hz	
		X9 4000K CRI90/4103 lm	F1 59°	XB CASAMBI 220-240V/ 50-60Hz BB 33V/Max. 1050mA	
 AU22 - Einflamming / Aufbau Singolo / Superficie IP23 	AA GU10	G1	NA	BU /100-240V/50-60Hz	

nicht inklusive / Non incluso

Wabenraster
Pannello a nido d'ape



71-A855-60-00

MULTIDIR EVO

Multidir Big Double

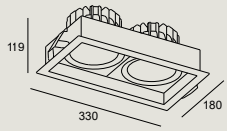
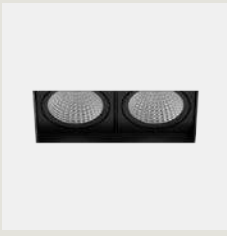
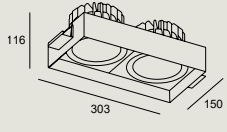

Codebeispiel / Esempio di codice: AU19-18V9S30U14

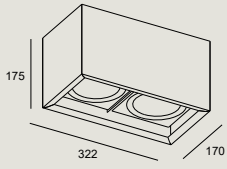
Model	W	K/ Cri/ Real lm	Optics	Source	Finishes
 <p>AU19 - Zweiflamming / Einbau / Mit Rahmen Doppio / Incasso / Con Cornice 302x160 IP23</p> 	18 2 x 16,6W	V9 2700K CRI90/2 x 1995 lm	S3 15°	OU ON-OFF 100-240V/50-60Hz	60 14 NOT FOR AU21 34 NOT FOR AU21
		W9 3000K CRI90/2 x 2010 lm	M3 23°	DS DALI-2 110-277V/50-60Hz	
		X9 4000K CRI90/2 x 2126 lm	F1 59°	XB CASAMBI 220-240V/ 50-60Hz BB 33V/Max. 500mA	
	25 2 x 23,1W	V9 2700K CRI90/2 x 2676 lm	S3 15°	OU ON-OFF 100-240V/50-60Hz	
		W9 3000K CRI90/2 x 2696 lm	M3 23°	DS DALI-2 110-277V/50-60Hz	
		X9 4000K CRI90/2 x 2852 lm	F1 59°	XB CASAMBI 220-240V/ 50-60Hz BB 33V/Max. 700mA	
	 <p>AU21 - Zweiflamming / Einbau / Ohne Rahmen Doppio / Incasso / Senza Cornice 303x150 IP23</p> 	33 2 x 30,3W	V9 2700K CRI90/2 x 3351 lm	S3 15°	OS ON-OFF 220-240V/50-60Hz
			W9 3000K CRI90/2 x 3375 lm	M3 23°	DS DALI-2 110-277V/50-60Hz
			X9 4000K CRI90/2 x 3571 lm	F1 59°	XB CASAMBI 220-240V/ 50-60Hz BB 33V/Max. 900mA
39 2 x 35,8W		V9 2700K CRI90/2 x 3850 lm	S3 15°	OU ON-OFF 100-240V/50-60Hz	
		W9 3000K CRI90/2 x 3878 lm	M3 23°	DS DALI-2 220-240V/50-60Hz	
		X9 4000K CRI90/2 x 4103 lm	F1 59°	XB CASAMBI 220-240V/ 50-60Hz BB 33V/Max. 1050mA	
 <p>AU23 - Zweiflamming / Aufbau Doppio / Superficie IP23</p> 		AA 2 x GU10	G1	NA	BU /100-240V/50-60Hz

nicht inklusive / Non incluso

Wabenraster
Pannello a nido d'ape

71-A855-60-00



Pendelleuchten

Sospensioni



Iris

297

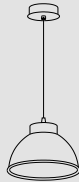

Pek

300

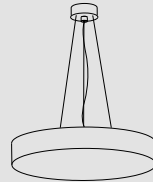

Luno

302



Iris

SUMMALAB 2022

BODY MAT		50000h	2
AL		L80 B20	MacAdam



2 Module mit verschiedenen Leistungen

2 moduli con varie potenze

Iris ist als Hängeleuchte mit möglicher Aufbauinstallation (für Decken, die keinen Einbau erlauben) und in einer minimalistischen Version mit externem Gerät erhältlich.

Iris si presenta nella sua versione a sospensione con possibilità di installazione accostata (per soffitti che non consentono di nascondere l'apparecchiatura) e opzioni minimaliste con apparecchiatura remota.

Iris umfasst 2 Module mit verschiedenen Leistungen (6 W / 12 W / 18 W) zur Anpassung an die Projektanforderungen. Die Module können mit den verschiedenen Anwendungen der Kollektion und allen Diffusor-Optionen kombiniert werden.

Iris offre 2 moduli con varie potenze (6W / 12W / 18 W) per adattarsi alle esigenze del progetto. I moduli sono combinabili con le applicazioni possibili della collezione e con tutti i modelli di diffusori.



18W

12W

6W

Polycarbonatlinse Lente in policarbonato

Die Basis der Produktfamilie Iris enthält eine Polycarbonat-Linse mit 3 verschiedenen Öffnungen, um das Licht ohne Abweichungen scharf und präzise projizieren zu können.

Il nucleo di Iris integra una lente in policarbonato con 3 diverse aperture in grado di proiettare la luce senza aberrazioni, in modo chiaro e preciso.



Ein Licht für jeden Augenblick Una luce per ogni momento

In allen Ausführungen ist Iris mit 5 verschiedenen Diffusoren erhältlich, mit denen die Silhouette und die Wahrnehmung der Leuchte verändert und an die Anforderungen jedes Projekts angepasst werden können. Die kegelförmigen, ovalen und zylindrischen Glasschirme sind ideal für eher dekorative Projekte, während die Ring- und Visual Comfort-Optionen besser zu technischen Umgebungen passen.

In tutte le sue versioni Iris offre la possibilità di scegliere tra 5 diffusori che cambiano la sagoma e la percezione della lampada, adattandola così alle esigenze di ogni progetto. Gli schermi di vetro, di forma conica, ovale e cilindrica, sono ideali per progetti più decorativi, mentre le opzioni anello e Comfort Visual sono perfette per ambienti più tecnici.

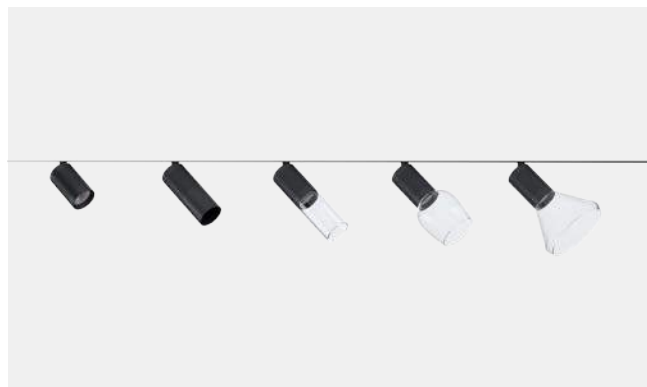



IRIS

Pendant

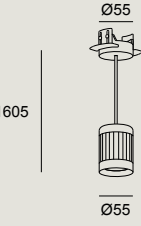
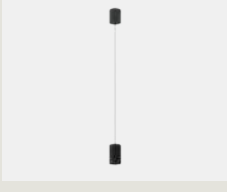
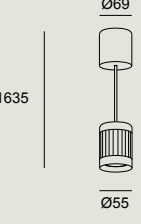

Codebeispiel / Esempio di codice: AV14-P6V9U10S60

Model	W	K/ CRI/ Real lm	Shade	Optics	Source	Finishes	
 <p>AV14 - Pendelleuchten / Mit Rahmen Sospensioni / Trim Ⓢ 57</p> 	P6 6W	V9 2700K/ CRI90/692 lm	U Hoop	1 15°	OS  ON-OFF/ 220-240V/ 50-60Hz	60 ●	
		W9 3000K/CRI90/ 692 lm	V Visual Comfort	2 35°			DS  DALI-2/ 110-277V/ 50-60Hz
		X9 4000K/CRI90/ 695 lm	X Cone	3 50°			
		12 12W	V9 2700K/CRI90/ 1181 lm	Y Glass			
			W9 3000K/CRI90/ 1181 lm	Z Pipe			
			X9 4000K/CRI90/ 1181 lm				
 <p>AV15 - Pendelleuchten / Randlos Sospensioni / Trimless Ⓢ 57</p> 	18 18W	V9 22700K/CRI90/ 1325 lm					
		W9 3000K/CRI90/ 1325 lm					
		X9 4000K/CRI90/ 1325 lm					
 <p>AV16 - Pendelleuchten / Aufputz Sospensioni / Superficie</p> 							

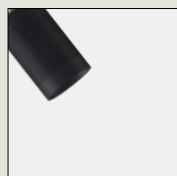

Hoop



Visual Comfort



Cone



Glass



Pipe

nicht inklusive / Non incluso

Wabenraster x 5 / Pannello a nido d'ape (5 unità)	71-5166-60-00
Elliptischer Diffusor x 5 / Diffusore ellittico (5 unità)	71-5167-00-00
5Weichzeichnerlinse x 5 / Sagomatore di fascio (5 unità)	71-6099-00-00
Schirm x 5 / Screen x 5	71-7894-60-00
Quadratischer Diffusor x 5 / Diffusore quadrato (5 unità)	71-5658-00-00

Pek

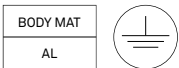

Pendelleuchte mit glockenförmigen Design. Diese aus Aluminium hergestellte Leuchte erzeugt einen gleichmäßigen Lichtkegel, der sich bestens zur Beleuchtung großer multifunktionaler Flächen eignet. Kann als Pendelleuchte (mit dem mitgelieferten 400 mm bis 2.870 mm langen Kabel) oder mithilfe einer Stromschiene und unserem Track-Adapter-Zubehör installiert werden. Cree-LED System mit hohem Lichtstrom im Bereich zwischen 3220 lm und 5120 lm.

Apparecchio sospeso con un'estetica a forma di campana. Realizzato in alluminio, offre un fascio di luce omogeneo, ideale per illuminare grandi spazi polivalenti. Può essere installato come placca fissata al soffitto (dispone di un cavo di sospensione di grande lunghezza che va dai 400 mm ai 2.870 mm) o mediante binario, con un accessorio connettore. Dispone di CREE LED, con un elevato flusso luminoso che va dai 3220lm ai 5120lm.



Modelloptionen und Ausführungen

Opzioni di modelli e finiture

Pek wird in einer Cree-LED und einer E27-Version angeboten, die wiederum in weißer oder schwarzer Ausführung erhältlich sind. Pek è disponibile in versione LED Cree ed E27, entrambe con finiture in bianco e nero.



PEK

50000h	2	
L80 B20	MacAdam	ON-OFF

14 60

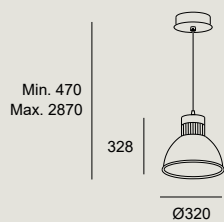

LED					
K	CRI	W LED	W TOTAL	Real Lm	Code
3000	80	42	44	2512	00-4941
3000	80	42	44	4193	00-4947 - 14 - 00
3000	90	42	44	3347	00-4953 - 60 - 00
4000	80	42	44	2512	00-4944 - 14 - 00
4000	80	42	44	4193	00-4950 - 60 - 00

100-240V 50-60Hz

IP
20

14 60

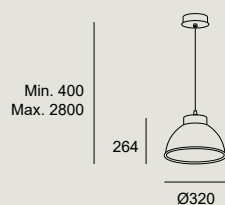

E27		
W	W TOTAL	Code
60	60	00-4962 - 14 - 00
		60 - 00

nicht inklusive / Non incluso	
Anschluss Weiß für Verbindung mit Hängeleuchten an Schienensystem Connettore bianco per il collegamento delle sospensioni su binario	71-2232-14-14
Anschluss Schwarz für Verbindung mit Hängeleuchten an Schienensystem Connettore nero per il collegamento delle sospensioni su binario	71-2232-60-60
Schienensteckverbinder Connettore per binario	71-3531-60-00



Luno Pendant

BODY MAT	DIF MAT		50000h	3
AL	PMMA		L80 B20	MacAdam



IP	UGR	WELL
20	<22	

14  60  DL* 

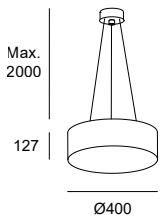

LED						
K	CRI	W LED	W TOTAL	Real Lm	Code	
3000	80	24.5	26.8	2389	00-5922 - 14 - 60 - DL	OU RU
4000	80	24.5	26.8	2389	00-5923 - 14 - 60 - DL	OU RU

	OU ON-OFF	100-240V	50-60Hz
RU	1-10V	100-240V	50-60Hz

IP	UGR	WELL
20	<19	

14  60  DL* 

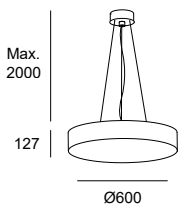

LED						
K	CRI	W LED	W TOTAL	Real Lm	Code	
3000	80	52	60	5083	00-5924 - 14 - 60 - DL	OU RU
4000	80	52	60	5083	00-5925 - 14 - 60 - DL	OU RU

	OU ON-OFF	100-240V	50-60Hz
RU	1-10V	100-240V	50-60Hz

*Fragen Sie unser Verkaufsteam nach den Lieferbedingungen.

Consultare i termini e le condizioni di consegna al nostro team commerciale.

Luno Pendant

BODY MAT	DIF MAT		50000h	3
AL	PMMA		L80 B20	MacAdam



IP	UGR	WELL
20	<19	

14 60 DL*

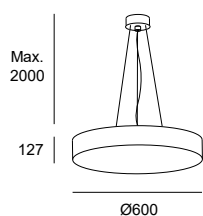

LED						
K	CRI	W LED	W TOTAL	Real Lm	Code	
3000	80	97	105	9687	00-5926 - 14 - 60 - DL	OU RU
4000	80	97	105	9687	00-5927 - 14 - 60 - DL	OU RU

	OU ON-OFF	100-240V	50-60Hz
	RU 1-10V	100-240V	50-60Hz

IP	WELL
20	

14 60 DL*

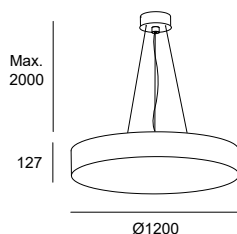

LED						
K	CRI	W LED	W TOTAL	Real Lm	Code	
3000	80	146	156.1	15065	00-5928 - 14 - 60 - DL	OU RU
4000	80	146	156.1	15065	00-5929 - 14 - 60 - DL	OU RU

	OU ON-OFF	100-240V	50-60Hz
	RU 0-10V	100-240V	50-60Hz



Wandleuchten/ Deckenleuchten

Lampade da parete/ Plafoniere



Iris

307

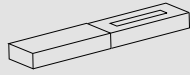

Maai

312

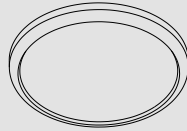

Leco

314



Luno

317

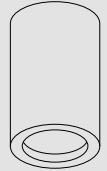

Gea

322



Play

323

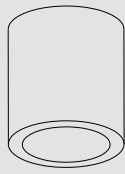

Exit

324



Iris

SUMMALAB 2022

BODY MAT		50000h	2
AL		L80 B20	MacAdam



2 Module mit verschiedenen Leistungen 2 moduli con varie potenze

In der modularen Produktfamilie Iris gibt es eine Wand/Deckenleuchtenversion, die sich ideal für Projekte eignet, bei denen keine Schiene erforderlich ist.

La famiglia modulare Iris ha una versione applique/plafoniera ideale per progetti che non richiedono la versatilità di un binario.

Iris umfasst 2 Module mit verschiedenen Leistungen (6 W / 12 W / 18 W) zur Anpassung an die Projektanforderungen. Die Module können mit den verschiedenen Anwendungen der Kollektion und allen Diffusor-Optionen kombiniert werden.

Iris offre 2 moduli con varie potenze (6 W / 12 W / 18 W) per adattarsi alle esigenze del progetto. I moduli sono combinabili con le applicazioni possibili della collezione e con tutti i modelli di diffusori.



18 W

12 W

6 W

Polycarbonatlinse Lente in policarbonato

Die Basis der Produktfamilie Iris enthält eine Polycarbonat-Linse mit 3 verschiedenen Öffnungen, um das Licht ohne Abweichungen scharf und präzise projizieren zu können.

Il nucleo di Iris integra una lente in policarbonato con 3 diverse aperture in grado di proiettare la luce senza aberrazioni, in modo chiaro e preciso.

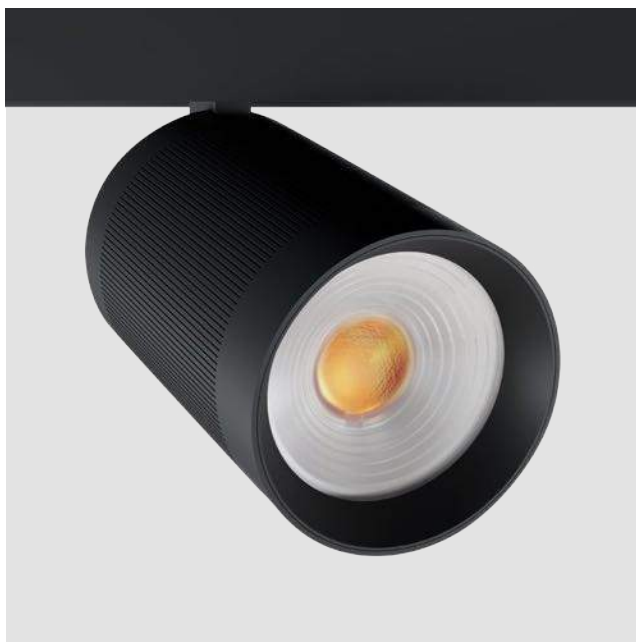

Ein Licht für jeden Augenblick Una luce per ogni momento

In allen Ausführungen ist Iris mit 5 verschiedenen Diffusoren erhältlich, mit denen die Silhouette und die Wahrnehmung der Leuchte verändert und an die Anforderungen jedes Projekts angepasst werden können. Die kegelförmigen, ovalen und zylindrischen Glasschirme sind ideal für eher dekorative Projekte, während die Ring- und Visual Comfort-Optionen besser zu technischen Umgebungen passen.

In tutte le sue versioni Iris offre la possibilità di scegliere tra 5 diffusori che cambiano la sagoma e la percezione della lampada, adattandola così alle esigenze di ogni progetto. Gli schermi di vetro, di forma conica, ovale e cilindrica, sono ideali per progetti più decorativi, mentre le opzioni anello e Comfort Visual sono perfette per ambienti più tecnici.

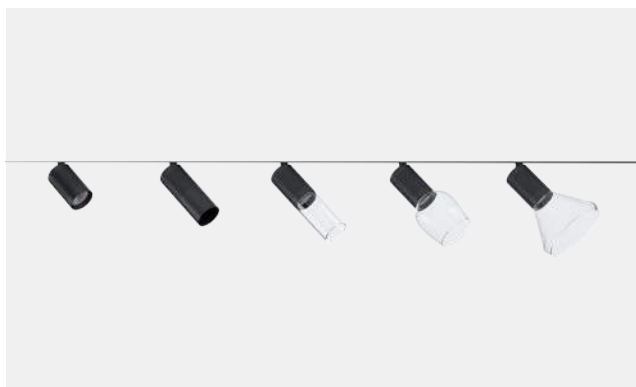

Vielfältiges Zubehör Varietà di accessori

Die Diffusor-Optionen können mit 5 Zubehörteilen ergänzt werden, die das Licht entweder auf einen Punkt fokussieren oder streuen, um eine homogenere Raumwirkung zu erzielen. Bei den Ausführungen ohne Glasdiffusor können alle Zubehörteile außer dem Ring eingesetzt werden.

Le opzioni di diffusore possono essere completate da 5 accessori, che modulano la luce o per focalizzarla su un punto o per sfumarla e ottenere un effetto più omogeneo nello spazio. Nelle opzioni senza diffusore di vetro è possibile usare tutti gli accessori tranne l'anello.



Online-Konfigurator Configuratore online



Konfigurieren Sie Ihre Leuchte
Configura il tuo apparecchio

Mit dem Online-Konfigurator von LEDS C4 lassen sich auf praktische und effektive Weise Leuchten zusammenstellen, die ganz auf das jeweilige Projekt zugeschnitten sind.

Grazie allo strumento di configurazione online di LEDS C4 è possibile creare, in modo pratico ed efficace, un apparecchio di illuminazione completamente adattato ad ogni progetto.

iris.leds-c4.com



1. Beleuchtungskonfiguration (Auswahl: Installation, Leistung, Diffusor, Zubehör, Farbtemperatur, Optik, Dimmung)
Configurazione dell'apparecchio (selezione: installazione, potenza, diffusore, accessorio, temperatura di colore, ottica, regolazione)







2. Dokumentation herunterladen
Scaricare documentazione

IRIS

Ceiling

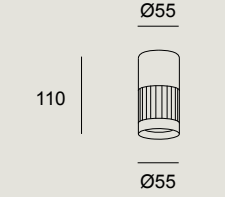

Codebeispiel / Esempio di codice: AV17-P6V9U10S60

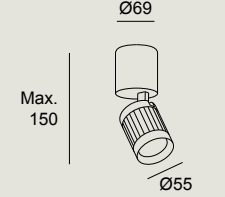
Model	W	K/ CRI/ Real lm	Shade	Optics	Source	Finishes	
 <p>AV17 - Deckenleuchten / Fest Plafoniere / Fisso</p> 	P6 6W	V9 2700K/CRI90/ 692 lm	U Hoop	1 15°	OS  ON-OFF/ 220-240V/ 50-60Hz	60 	
		W9 3000K/CRI90/ 692 lm	V Visual Comfort	2 35°			DS  DALI-2/ 110-277V/ 50-60Hz
		X9 4000K/CRI90/ 695 lm	X Cone	3 50°			
	12 12W	V9 2700K/CRI90/ 1181 lm	Y Glass				
		W9 3000K/CRI90/ 1181 lm	Z Pipe				
		X9 4000K/CRI90/ 1181 lm					
 <p>AV13 - Deckenleuchten / Strahler Plafoniere / Proiettori</p> 	18 18W	V9 2700K/CRI90/ 1325 lm					
		W9 3000K/CRI90/ 1325 lm					
		X9 4000K/CRI90/ 1325 lm					

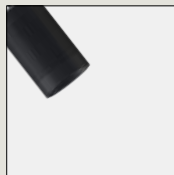

Hoop

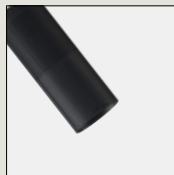

Visual Comfort



Cone

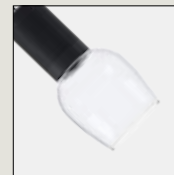

Glass



Pipe

nicht inklusive / Non incluso

Wabenraster x 5 / Pannello a nido d'ape (5 unità)	71-5166-60-00
Elliptischer Diffusor x 5 / Diffusore ellittico (5 unità)	71-5167-00-00
5Weichzeichnerlinse x 5 / Sagomatore di fascio (5 unità)	71-6099-00-00
Schirm x 5 / Screen x 5	71-7894-60-00
Quadratischer Diffusor x 5 / Diffusore quadrato (5 unità)	71-5658-00-00

IRIS

Spotlight



Codebeispiel / Esempio di codice: AV11-P6V9U10S60

Model	W	K/ CRI/ Real lm	Shade	Optics	Source	Finishes	
 <p>AV11 - Strahler / Mit Rahmen Proiettori / Trim Ⓢ 57</p> <p>Ø55</p> <p>Max. 120</p> 	P6 6W	V9 2700K/CRI90/ 692 lm	U Hoop	1 15°	OS  ON-OFF/ 220-240V/ 50-60Hz DS  DALI-2/ 110-277V/ 50-60Hz	60 ●	
		W9 3000K/CRI90/ 692 lm	V Visual Comfort	2 35°			
		X9 4000K/CRI90/ 695 lm	X Cone	3 50°			
	12 12W	V9 2700K/CRI90/ 1181 lm	Y Glass				
		W9 3000K/CRI90/ 1181 lm	Z Pipe				
		X9 4000K/CRI90/ 1181 lm					
 <p>AV12 - Strahler / Randlos Proiettori / Trimless Ⓢ 57</p> <p>Ø55</p> <p>Max. 120</p> 	18 18W	V9 2700K/CRI90/ 1325 lm					
		W9 3000K/CRI90/ 1325 lm					
		X9 4000K/CRI90/ 1325 lm					
 <p>AV13 - Strahler / Deckenleuchten Proiettori / Plafoniere</p> <p>Ø69</p> <p>Max. 150</p> 							

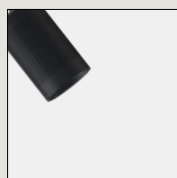

Hoop

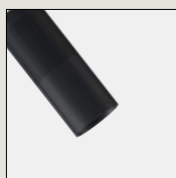

Visual Comfort



Cone



Glass



Pipe

nicht inklusive / Non incluso

Wabenraster x 5 / Pannello a nido d'ape (5 unità)	71-5166-60-00
Elliptischer Diffusor x 5 / Diffusore ellittico (5 unità)	71-5167-00-00
5Weichzeichnerlinse x 5 / Sagomatore di fascio (5 unità)	71-6099-00-00
Schirm x 5 / Screen x 5	71-7894-60-00
Quadratischer Diffusor x 5 / Diffusore quadrato (5 unità)	71-5658-00-00

Maai

BODY MAT	DIF MAT		50000h	3
AL	ACR		L80 B20	MacAdam

Aus der Zusammenarbeit zwischen Summalab und LEDS C4 ist Maai entstanden, eine vielseitige Leuchte mit leichter und ausgewogener Struktur, die sich ganz einfach in jede Art von Raum integrieren lässt. Maai ist die perfekte Verbindung von Ästhetik und Technologie.

Dalla collaborazione tra Summalab e LEDS C4 nasce Maai, un'applicazione versatile con una struttura leggera ed equilibrata, facilmente adattabile a qualsiasi spazio. Maai è la fusione perfetta tra estetica e tecnologia.



Höchste Gleichmäßigkeit und visueller Komfort
Massima uniformità e comfort visivo

Maai verfügt über zwei Diffusoren, einen inneren mikrogravierten Diffusor für ein Höchstmaß an Gleichmäßigkeit und einen äußeren Mikrovertex-Diffusor, der optimalen Sehkomfort gewährleistet.

Maai combina due diffusori, uno interno micro inciso, per massimizzare l'uniformità ed uno esterno, in micro vertici, che fornisce un ottimo comfort visivo.



Exzentrische Achse
Asse eccentrico

Der verborgene Drehpunkt ermöglicht es dem Kopf, sich um 350° zu drehen und somit jeden Punkt im Raum unabhängig vom Montageort zu beleuchten.

Il suo asse eccentrico e regolabile a 350° permette di illuminare qualsiasi punto della stanza, qualunque sia il suo luogo di installazione.

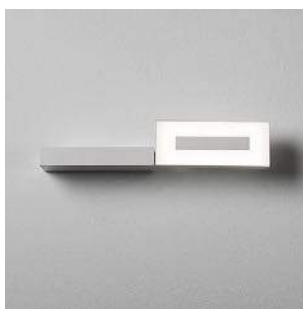

MAAI

IP	
20	350

14

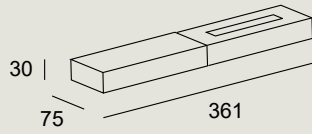

LED						
K	CRI	W LED	W Total	Real Lm	Code	
3000	80	11.6	13.2	1042	05-6399 - 14 -	DU
3000	80	11.6	13.8	1042		OU
3000	80	24.5	28	1908	05-6408 - 14 -	DS
3000	80	24.5	28.1	1908		OU
4000	80	11.6	13.2	1097	05-6405 - 14 -	DU
4000	80	11.6	13.8	1097		OU
4000	80	24.5	28	2010	05-6411 - 14 -	DS
4000	80	24.5	28.1	2010		OU

	DS	DALI	220-240V	50-60Hz
	DU	DALI	100-240V	50-60Hz
	OU	ON-OFF	100-240V	50-60Hz



Leco

BODY MAT	DIF MAT		50000h	3
PC	PC		L80 B20	MacAdam

Leco ist eine Aufputz-Notleuchte, die sich ideal für die Beleuchtung von Durchgängen wie Fluren oder öffentlichen Bereichen eignet. Das Gehäuse wurde einer speziellen UV-Behandlung unterzogen, die das Vergilben der Materialien verhindert und für längere Zeit einen einwandfreien Zustand gewährleistet. Diese Leuchte kann im Normalbetrieb und bei Stromausfall auch im Notbetrieb eingesetzt werden.

Leco è un apparecchio di illuminazione di emergenza da superficie, ideale per l'illuminazione di zone di passaggio come corridoi od aree comuni. Il suo corpo incorpora uno speciale trattamento UV che evita l'ingiallimento dei materiali e garantisce un perfetto stato duraturo nel tempo. Questo apparecchio può essere utilizzato, funzionando in modo standard e in caso di emergenza, in caso di guasto elettrico.



LED-Statusleuchte an der Seite der Leuchte

LED indicatore posto sul lato dell'apparecchio

Mit grüner LED-Statusleuchte an der Seite der Leuchte.
Include un LED indicatore verde sul lato dell'apparecchio.



Überwachung mit DALI

Monitoraggio DALI

Bei den DALI-Versionen lässt sich der Betriebszustand in Echtzeit überwachen.

Grazie alle versioni DALI è possibile eseguire il monitoraggio, in tempo reale, del suo stato operativo.



Die Referenzen für die Kollektion Leco Emergency sind ab Seite 914 zu finden.
Trova i codici della collezione Leco Emergenza a partire dalla pagina 914.

LECO

IK	IP	LOW	
10	44	FLICKER	ON-OFF

14

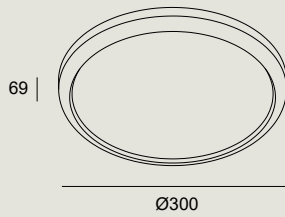

LED				
K	CRI	W	Real Lm	Code
4000	80	8.7	911	15-A003 - 14 - OU
220-240V		50-60Hz		

IK	IP	LOW	
10	44	FLICKER	ON-OFF

14

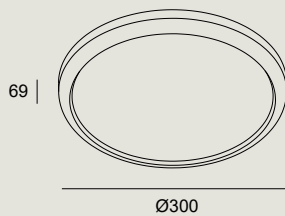

LED K:4000 CRI:80 BATTERY:NiCd						
W	Real Lm	Real Lm. Em	H. emergency	Perma- nent	Auto test	Code
8.7	911	113	3	Yes	No	15-A003 - 14 - OE
220-240V		50-60Hz				

IK	IP	LOW	
10	44	FLICKER	DALI

14

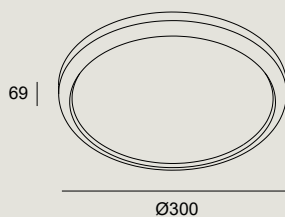

LED K:4000 CRI:80 BATTERY:LiFePO4						
W	Real Lm	Real Lm. Em	H. emergency	Perma- nent	Auto test	Code
8.7	911	200	3	Yes	Yes	15-A003 - 14 - DE
220-240V		50-60Hz				





Luno

BODY MAT		50000h	3
AL		L80 B20	MacAdam



Mikroprismatischer Diffusor Diffusore Microprismatico

Luno ist eine Kollektion mit zylindrischen Formen und klarer Linienführung. Sie ist in verschiedenen Installations- und Größenvarianten erhältlich und bietet somit eine Vielzahl von Möglichkeiten für die Beleuchtung großer Räume wie Hörsäle, Konferenzräume, Restaurants oder Hotellobbys.

Luno è una collezione dalla forma cilindrica e linee pulite. Esistono diversi tipi di installazione e misure, che si traducono in una moltitudine di possibilità nell'illuminazione di grandi spazi come auditorium, sale conferenza, ristoranti o hall di hotel.

Die Surface-Version beinhaltet Modelle mit Opal-Diffusor für eine gleichmäßige Ausleuchtung sowie Modelle mit mikroprismatischen Diffusor, der für ein hohes Maß an Sehkomfort sorgt.

La versione Surface comprende modelli Opal, per un'illuminazione uniforme e con diffusore microprismatico, con un ottimo grado di comfort visivo.



Smart-Funktionen: Zirkadianer Rhythmus Funzionalità Smart: Ciclo circadiano

Durch die Kombination von TW-Technologie und Leuchtensystem kann die Innenbeleuchtung so programmiert werden, dass sie je nach Standort der Anlage die natürliche Außenszene sehr präzise reproduziert und so zum Wohlbefinden der Menschen beiträgt und ihren Wach- und Schlafzyklus unterstützt.

Mediante il binomio sistema connettivo ed apparecchio TW, è possibile programmare l'illuminazione interna in modo da riprodurre in modo piuttosto preciso l'illuminazione naturale esterna, a seconda della posizione dell'impianto, aiutando il benessere delle persone e il loro ciclo di veglia e di sonno.

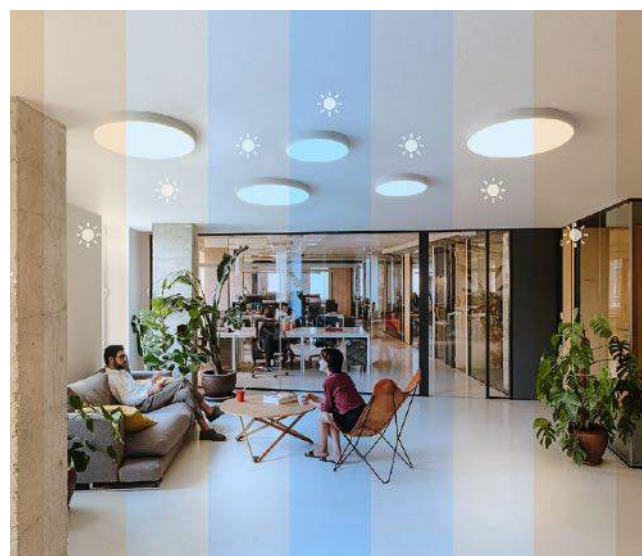

LUNO

Luno Surface Low UGR Microprismatic

DIF MAT	IP	LOW	UGR	WELL	(SC)
PMMA, PLABS	23	FLICKER	<16		

14 60

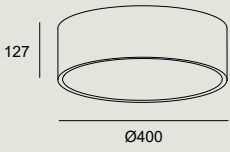

LED						
K	CRI	W LED	W Total	Real Lm	Code	
3000	80	24.5	27.5	2045	15-7806 - 14 - 60	DS
4000	80	24.5	27.5	2045	15-7807 - 14 - 60	DS
TW 2700-6500	90	22.4	28	1584	15-7810 - 14 - 60	TW

	DS	DALI	220-240V	50-60Hz
	TW	DALI DT8	220-240V	50-60Hz

IP	LOW	UGR	WELL	(SC)
23	FLICKER	<16		

14 60

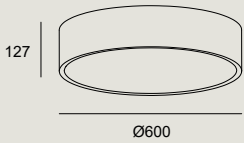

LED						
K	CRI	W LED	W Total	Real Lm	Code	
3000	80	52	59	4380	15-7808 - 14 - 60	DS
4000	80	52	59	4380	15-7809 - 14 - 60	DS
TW 2700-6500	90	47	55.3	4432	15-7811 - 14 - 60	TW

	DS	DALI	220-240V	50-60Hz
	TW	DALI DT8	220-240V	50-60Hz

LUNO



Luno Surface Opal

DIF MAT	IP	UGR	LOW	WELL	(SC)
PMMA	23	<19	FLICKER		

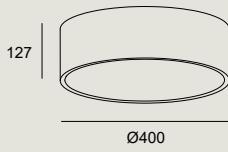
14  60 



LED						
K	CRI	W LED	W Total	Real Lm	Code	
3000	80	24.5	27.5	2389	15-5922 - 14 - 60	DS
4000	80	24.5	27.5	2389	15-5923 - 14 - 60	DS
TW 2700-6500	90	22.4	28	1892	15-7842 - 14 - 60	TW



 DS	DALI	220-240V	50-60Hz
 TW	DALI DT8	220-240V	50-60Hz

DIF MAT	IP	UGR	LOW	WELL	(SC)
PMMA	23	<19	FLICKER		

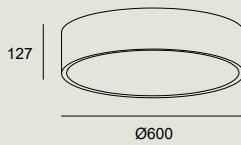
14  60 



LED						
K	CRI	W LED	W Total	Real Lm	Code	
3000	80	52	59	5083	15-5924 - 14 - 60	DS
4000	80	52	59	5083	15-5925 - 14 - 60	DS
TW 2700-6500	90	47	55.3	4028	15-7843 - 14 - 60	TW

 DS	DALI	220-240V	50-60Hz
 TW	DALI DT8	220-240V	50-60Hz

LUNO

Luno Surface

DIF MAT	IP	UGR	WELL
PMMA	20	<22	

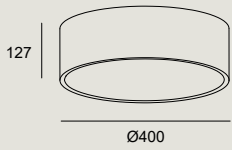

14  60  DL* 



LED						
K	CRI	W LED	W Total	Real Lm	Code	
3000	80	24.5	26.8	2389	15-5922 - 14 - 60 - DL	OU RU
4000	80	24.5	26.8	2389	15-5923 - 14 - 60 - DL	OU RU

	OU ON-OFF	100-240V	50-60Hz
	RU 1-10V	100-240V	50-60Hz

DIF MAT	IP	UGR	WELL
PMMA	20	<19	

14  60  DL* 

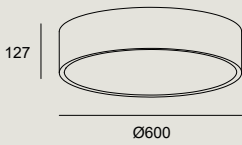

LED						
K	CRI	W LED	W Total	Real Lm	Code	
3000	80	52	60	5083	15-5924 - 14 - 60 - DL	OU RU
4000	80	52	60	5083	15-5925 - 14 - 60 - DL	OU RU

	OU ON-OFF	100-240V	50-60Hz
	RU 1-10V	100-240V	50-60Hz

LUNO

Luno Surface

DIF MAT	IP	UGR	LOW	WELL
PMMA	20	<19	FLICKER	

14  60  DL* 

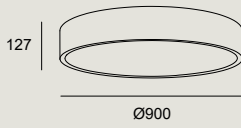

LED						
K	CRI	W LED	W Total	Real Lm	Code	
3000	80	97	105	9687	15-5926 - 14 - 60 - DL	OU RU
4000	80	97	105	9687	15-5927 - 14 - 60 - DL	OU RU

	OU ON-OFF	100-240V	50-60Hz
	RU 1-10V	100-240V	50-60Hz

DIF MAT	IP	UGR	LOW	WELL
PMMA	20	<19	FLICKER	

14  60  DL* 

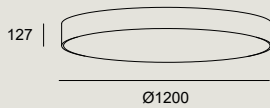

LED						
K	CRI	W LED	W Total	Real Lm	Code	
3000	80	146	156.1	15065	15-5928 - 14 - 60 - DL	OU RU
4000	80	146	156.1	15065	15-5929 - 14 - 60 - DL	OU RU

	OU ON-OFF	100-240V	50-60Hz
	RU 0-10V	100-240V	50-60Hz

*Fragen Sie unser Verkaufsteam nach den Lieferbedingungen.

Consultare i termini e le condizioni di consegna al nostro team commerciale.



Ges Surface

BODY MAT
PLSTER



IP
23

14 

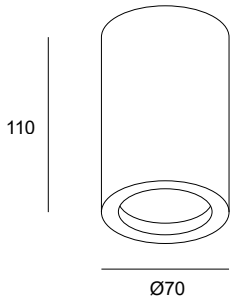

GU10		
W	W Total	Code
max. 7	7	15-5946 - 14 - 00

PLAY

Deco Surface

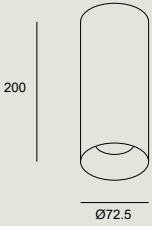

Codebeispiel / Esempio di codice: AG32-P7V9S20UWR

Model	W	K/ CRI/ Real lm	Optics	Source	Finishes
 <p>AG32 - Rund / Fest Rotondo / Fisso ⓘ 200 IP23</p> 	P7 6,4W	V9 2700K/CRI90 521 lm	S2 14°	OU ON-OFF/100-240V 50-60Hz	WR
		W9 3000K/CRI90 637 lm	M2 28°	TS PHASE CUT 220-240V 50-60Hz	WG
		X9 4000K/CRI90 642 lm	F1 49°	DS DALI-2 220-240V /50-60Hz	WH
	13 11,9W	V9 2700K/CRI90 1070 lm	S2 19°	OU ON-OFF/100-240V 50-60Hz	WL
		W9 3000K/CRI90 1276 lm	M2 35°	TS PHASE CUT 220-240V 50-60Hz	WM
		X9 4000K/CRI90 1344 lm	F1 45°	DS DALI-2 220-240V /50-60Hz	WN

P. 940

nicht inklusive / Non incluso

Installationsset Strahler Aufputz weiß Kit installazione proiettore di superficie bianco	71-5171-14-14
Installationsset Strahler Aufputz schwarz Kit installazione proiettore di superficie nero	71-5175-60-60
Aufhängeset 1500 mm Weiß Kit per sospensione ventilatori 1500mm colore bianco	71-5174-14-14
Aufhängeset 1500 mm Schwarz Kit per sospensione ventilatori 1500mm colore nero	71-5174-60-14
Installationsset Strahler Dreiphasenschiene weiß Kit installazione proiettore per binario trifase bianco	71-6481-14-14
Installationsset Strahler Dreiphasenschiene schwarz Kit installazione proiettore per binario trifase nero	71-6481-60-60

Smart Compatible-Zub. / Access. Smart Compatibile

71-5961-00-00 Dimmer DALI Casambi (DS)
71-5959-00-00 Dimmer Phase Cut Casambi (TS)

Exit

BODY MAT	50000h	2
AL	L80 B20	MacAdam

Exit ist eine Kollektion zylindrischer Anbauleuchten, ausgestattet mit modernster LED-Technik für eine hohe Farbwiedergabe in Räumen mit CRI 80 bis CRI 90 und minimaler Blendung sowie hohem Sehkomfort dank eines UGR-Werts von < 19.

Exit è una collezione di downlights cilindrici con una tecnologia interna, progettata per offrire un'alta riproduzione dei colori in spazi e prodotti con un CRI 80-CRI 90, un abbagliamento minimo ed un alto comfort visivo grazie ad un UGR inferiore a 19.



Ausführungen Opzioni di finiture

Dank ihrer Vielseitigkeit kann sie zur Beleuchtung von Objekten und Räumen mit unterschiedlichen speziellen Anforderungen eingesetzt werden. Exit ist in weißer und schwarzer Ausführung erhältlich.

La sua versatilità offre la possibilità di illuminare elementi e spazi con esigenze speciali diverse, con la possibilità di una finitura in bianco e nero.



Montagemöglichkeiten Possibilità di installazione

Die verschiedenen Zubehörteile von Exit lassen mehrere Installationsarten zu: Aufputzmontage mit direkter Anbringung an der Decke und Hängemontage mit Fleuron oder Schiene. Als ON/OFF-Variante oder mit DALI-Steuerung erhältlich.

I diversi accessori di Exit offrono vari tipi di installazione: in superficie con fissaggio diretto a soffitto e in sospensione mediante rosone o binario. Offre l'opzione ON / OFF o regolazione DALI.





Optionaler Aufhänge-Fleuron, nicht im Lieferumfang enthalten



Opzione rosone per sospensione non incluso



Schienensteckverbinder
Connettore per binario



EXIT

IP	UGR		
23	<19		

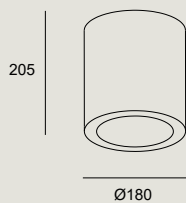
14  60 



LED						
K	CRI	W LED	W Total	Real Lm	Optics	Code
3000	80	25.9	26.9	2284	Medium 38°	90-3208 - 14 - 60 - OU DU
3000	80	29.6	37.4	2646	Medium 38°	90-3210 - 14 - 60 - OU
3000	90	25.9	26.9	1728	Medium 38°	90-3529 - 14 - 60 - OU DU
3000	90	33.7	37.4	2347	Medium 38°	90-3530 - 14 - 60 - OU
4000	80	25.9	26.9	2284	Medium 38°	90-3209 - 14 - 60 - OU DU
4000	80	29.6	37.4	2646	Medium 38°	90-3211 - 14 - 60 - OU

	OU	ON-OFF	100-240V	50-60Hz
	DU	DALI	100-240V	50-60Hz

nicht inklusive / Non incluso

Aufhängeset Weiß Kit sospensione bianco	71-3223-14-00
Aufhängeset Schwarz Kit sospensione nero	71-3223-60-00
Schienensteckverbinder Connettore per binario	71-3531-60-00

Smart Compatible-Zub. / Access. Smart Compatibile

71-5961-00-00 Dimmer DALI Casambi



Module Moduli

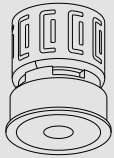

In

328

In

BODY MAT	DIF MAT	50000h	2
AL	PC	L80 B20	MacAdam

In ist ein hocheffizientes, professionelles Retrofit-System mit einer wesentlich höheren Lebensdauer als herkömmliche LED-Lampen. Seine geringen Abmessungen ermöglichen eine optimale Verwendung in abgehängten Decken mit geringer Einbautiefe. Verschiedene Modelle mit unterschiedlichen Leistungen und Lichtströmen (zwischen 529 lm und 1134 lm) sowie Optiken mit enger (Medium 24°), mittlerer (Medium 40°) oder diffuser (Flood 60°) Ausstrahlung für die Allgemeinbeleuchtung werden angeboten.

In è un sistema retrofit professionale di altissima efficienza con una durata di vita molto superiore a una lampada a led convenzionale. Di piccole dimensioni, il suo utilizzo è ottimale in controsoffitti di bassa altezza. È disponibile in diversi modelli con diverse potenze, flussi luminosi (tra 529lm e 1134lm) ed ottiche con fascio di luce concentrato (Medium 24°), medio (Medium 40°) o diffuso (Flood 60°), per l'illuminazione generale.



Kompatibles optisches System Sistema ottico compatibile

Externe Treiber ermöglichen es, die gewünschte Dimmart auszuwählen. Ausgestattet mit einem optischen LED-System, das mit den Kollektionen Dome, Ges und Split kompatibel ist. Dispone di un driver remoto con possibilità di scegliere il protocollo di regolazione desiderato e di un sistema ottico led compatibile con le collezioni Dome, Ges e Split.



Dome



Ges



Split

IN

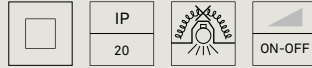

14

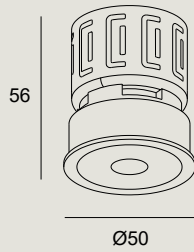

LED						
K	CRI	W LED	W Total	Real Lm	Optics	Code
2700	80	7	8.6	552	Medium 40°	71-4032 - 14 - M2
3000	80	7	8.6	529	Medium 40°	71-4033 - 14 - M2
		100-240V 50-60Hz				

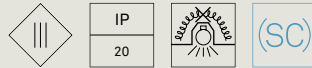

14

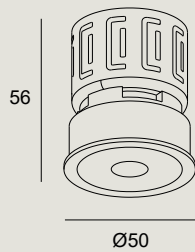

LED Max. 700mA 9V							
K	CRI	W LED	W Total	Real Lm	Optics	Code	
2700	80	7	8.6	552	Medium 40°	71-3885 - 14 - M2	
3000	80	7	8.6	529	Medium 40°	71-3886 - 14 - M2	
	ON-OFF			DALI2/PUSH			1-10V/PUSH
		PHASE CUT 240V					CASAMBI
71-6651		71-A190		71-7710		71-7663	71-A261

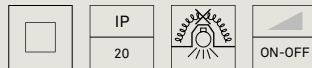

14

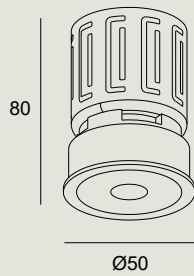

LED						
K	CRI	W LED	W Total	Real Lm	Optics	Code
2700	80	13	15.1	1095	Medium 40°	71-5156 - 14 - M2
3000	80	13	15.1	1134	Medium 40°	71-5157 - 14 - M2
		100-240V 50-60Hz				

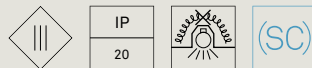

14

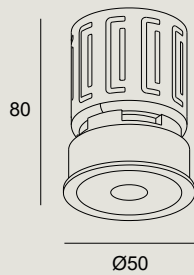

LED Max. 350mA 36V							
K	CRI	W LED	W Total	Real Lm	Optics	Code	
2700	80	13	15.1	1095	Medium 40°	71-5086 - 14 - M2	
3000	80	13	15.1	1134	Medium 40°	71-5087 - 14 - M2	
	ON-OFF			CASAMBI			DALI2/PUSH
		1-10V/PUSH					PHASE CUT 240V
71-6652		71-A260		71-A191		71-7710	71-A297

nicht mitgeliefertes
allgemeines Zub.
Access. comuni non inclusi

24°-Reflektor
Riflettore 24°

71-3887-00-00

60°-Reflektor
Riflettore 60°

71-3888-00-00



Signalisierung

Segnaletica



Paso

332

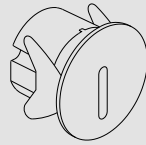

Bat

336

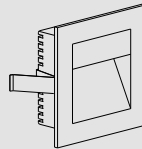

Sign

340

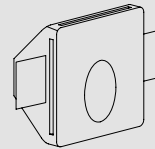

Secret

341

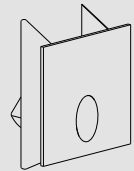

Step

342

Paso

BODY MAT	DIF MAT		50000h	3
AL	PVC		L80 B20	MacAdam

Paso ist eine Beleuchtungslösung zur Orientierung in Innenräumen mit einer Vielzahl von Lichteffekten in unterschiedlichen Öffnungen und Formen für jeden Bedarf. Dank ihrer geringen Größe fügt sie sich nahtlos in die Architektur ein und das elegante und minimalistische Design stellt das Licht in den Mittelpunkt. Ideal zur Beleuchtung von Fluren, Treppen und Durchgangsbereichen.

Passo è una collezione di segnaletica interna che offre una vasta gamma di effetti di luce con aperture e forme diverse, a seconda di ogni esigenza. Con dimensioni ridotte per consentire la massima integrazione architettonica, presenta un design elegante e minimalista che conferisce il massimo protagonismo alla luce. È stata progettata per illuminare corridoi, scale o aree di transito.

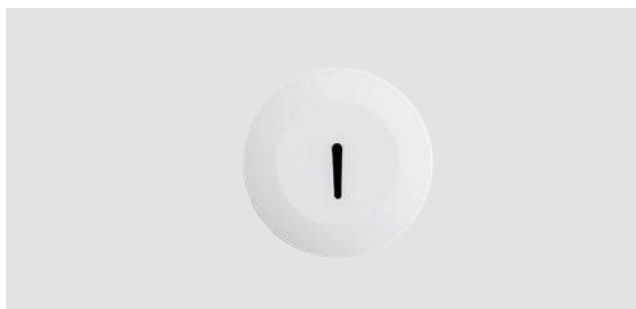

Verschiedene Lichteffekte Diversi effetti di luce

Paso ist in zwei Varianten erhältlich und bietet verschiedene Ausführungen mit unterschiedlichen Lichteffekten für jeden Bedarf, von kleinen Öffnungen für Treppenhäuser bis hin zu großen Öffnungen für Flure.

Disponibile in due finiture, Paso propone diversi modelli con vari effetti di luce per soddisfare ogni esigenza, da aperture strette ideali per scale, fino ad aperture di grande ampiezza, per corridoi.

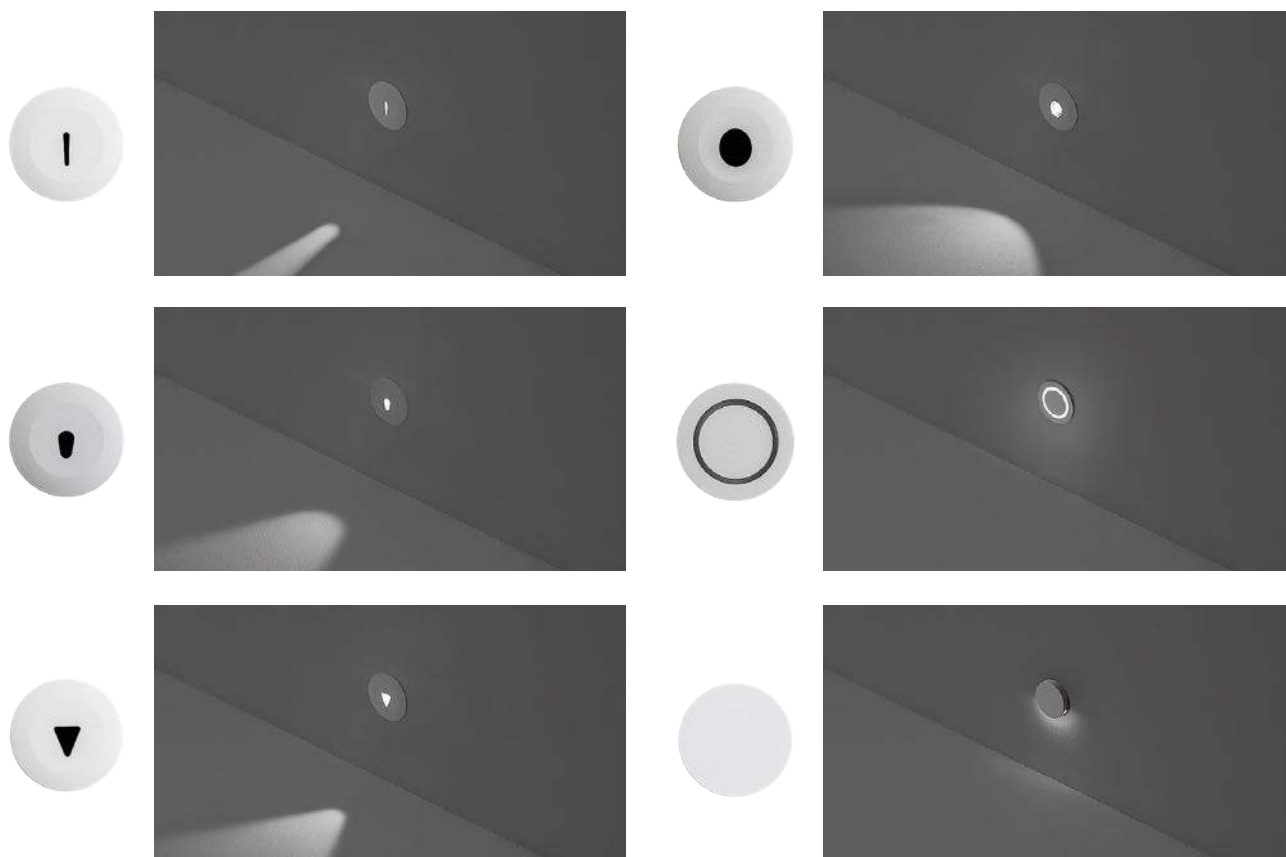

Minimale Einbautiefe Minima profondità di incasso

Aufgrund der minimalen Einbautiefe kann Paso in schmalen Wänden installiert werden.

Paso può essere installato su pareti strette in quanto richiede una profondità minima di incasso.



Minimalistisches Design Design minimal

Dank ihrem eleganten und minimalistischen Design liegt das Hauptaugenmerk auf dem Licht. Ideal zur Beleuchtung von Fluren, Treppen und Durchgangsbereichen.

Presenta un design elegante e minimal, che lascia spazio alla vera protagonista: la luce. Progettata per illuminare corridoi, scale o zone di passaggio.









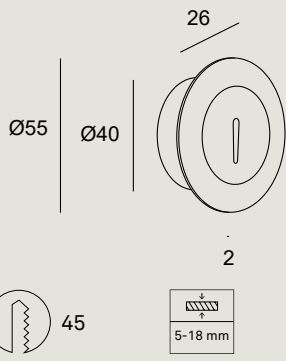



PASO

IP
42

14 









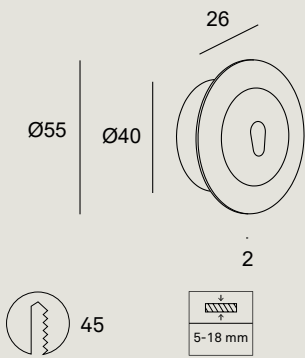



LED Max. 350mA 3V					
K	CRI	W LED	W Total	Real Lm	Code
3000	80	1	1	9	55-8024 - 14 - 00
1x max.25 	1x max.2 	1x max.15 	1x max.16 	1x max.15 	
 ON-OFF	 ON-OFF	 1-10V/PUSH	 PHASE CUT 240V/PUSH	 DALI/DALI2	
71-3542	71-8077	71-7710	71-4898	71-6192	

IP
42

N3 









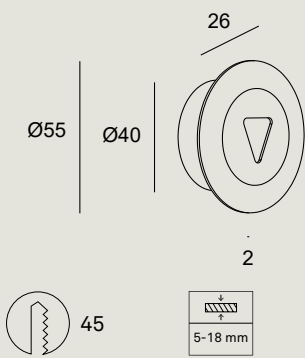



LED Max. 350mA 3V					
K	CRI	W LED	W Total	Real Lm	Code
3000	80	1	1	19	55-8025 - N3 - 00
1x max.25 	1x max.2 	1x max.15 	1x max.16 	1x max.15 	
 ON-OFF	 ON-OFF	 1-10V/PUSH	 PHASE CUT 240V/PUSH	 DALI/DALI2	
71-3542	71-8077	71-7710	71-4898	71-6192	

IP
42

14 



LED Max. 350mA 3V					
K	CRI	W LED	W Total	Real Lm	Code
3000	80	1	1	25	55-8026 - 14 - 00
1x max.25 	1x max.2 	1x max.15 	1x max.16 	1x max.15 	
 ON-OFF	 ON-OFF	 1-10V/PUSH	 PHASE CUT 240V/PUSH	 DALI/DALI2	
71-3542	71-8077	71-7710	71-4898	71-6192	

nicht mitgeliefert
allgemeines Zub.
Access. comuni non inclusi

Unterputzdose
Scatola da incasso









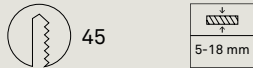
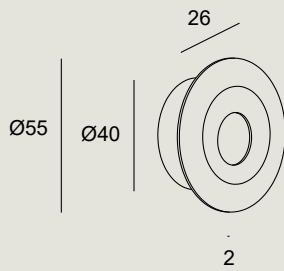

71-A775-00-00

PASO

IP
42

N3 











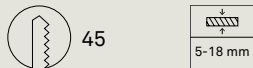
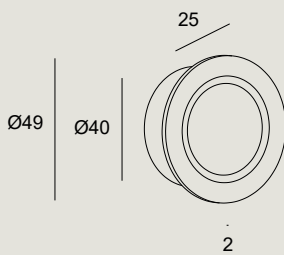

LED Max. 350mA 3V					
K	CRI	W LED	W Total	Real Lm	Code
3000	80	1	1	40	55-8027 - N3 - 00
1x max.25 	1x max.2 	1x max.15 	1x max.16 	1x max.15 	
 ON-OFF	 ON-OFF	 1-10V/PUSH	 PHASE CUT 240V/PUSH	 DALI/DALI2	
71-3542	71-8077	71-7710	71-4898	71-6192	

nicht inklusive / Non incluso	
Recess case Boîtier d'encastrement)	71-A775-00-00

IP
42

N3 











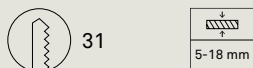
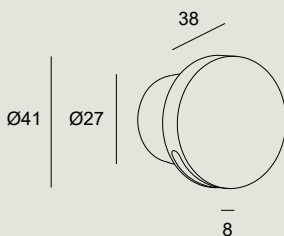

LED Max. 350mA 3V					
K	CRI	W LED	W Total	Real Lm	Code
3000	80	1	1	17	55-8028 - N3 - 00
1x max.25 	1x max.2 	1x max.15 	1x max.16 	1x max.15 	
 ON-OFF	 ON-OFF	 1-10V/PUSH	 PHASE CUT 240V/PUSH	 DALI/DALI2	
71-3542	71-8077	71-7710	71-4898	71-6192	

nicht inklusive / Non incluso	
Recess case Boîtier d'encastrement)	71-A775-00-00

IP
42

14 



LED Max. 350mA 3V					
K	CRI	W LED	W Total	Real Lm	Code
3000	80	1	1	2	55-8029 - 14 - 00
1x max.25 	1x max.2 	1x max.15 	1x max.16 	1x max.15 	
 ON-OFF	 ON-OFF	 1-10V/PUSH	 PHASE CUT 240V/PUSH	 DALI/DALI2	
71-3542	71-8077	71-7710	71-4898	71-6192	

nicht inklusive / Non incluso	
Recess case Boîtier d'encastrement)	71-A776-00-00



Bat

BODY MAT	DIF MAT		50000h	3
AL	GLA		L80 B20	MacAdam

Bat ist eine Beschilderungslösung für den Wandeinbau mit einer Vielzahl von Lichteffekten. Dank dem eleganten und minimalistischen Design ohne sichtbare Schrauben liegt das Hauptaugenmerk auf dem Licht.

Bat è una collezione di segnaletica a parete che offre un'ampia varietà di effetti di luce. Presenta un design elegante e minimal, senza viti a vista, che lascia spazio alla vera protagonista: la luce.

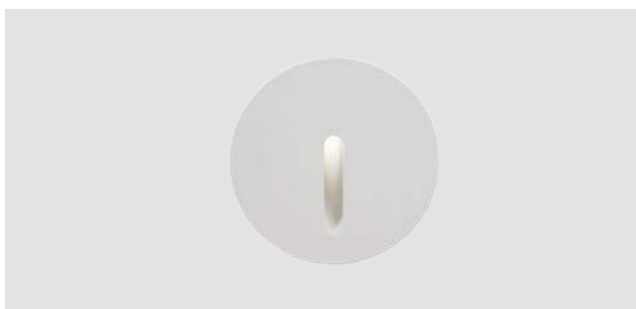

Verschiedene Ausführungen Molteplici finiture

Sie ist erhältlich in einer Größe mit 6 cm Durchmesser und vier verschiedenen Effektformaten; quadratisch und rund, beide mit einem engen und einem breiten Lichtstrahl. Die Kollektion bietet drei Farbtemperaturen (2700 K, 3000 K und 4000K) und drei verschiedene Oberflächen (anthrazitgrau, weiß und braun) um den Anforderungen eines jeden Projekts gerecht zu werden. È disponibile nella misura di 6 cm di diametro e 4 formati con diversi effetti, quadrato e rotondo, entrambi con un fascio di luce stretto ed ampio. La collezione prevede 3 temperature di colore, 2700K, 3000K e 4000K e 3 diverse finiture, grigio antracite, bianco e marrone per adattarsi alle esigenze di qualsiasi progetto.

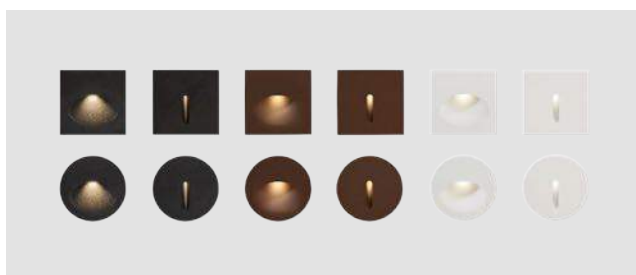

Hoher visueller Komfort Alto comfort visivo

Das Kopfteil von Bat weist ein besonderes Design auf, bei dem die LED versenkt ist und die Leuchte somit einen hohen visuellen Komfort bietet.

La testa di Bat ha un design speciale in modo che il LED sia incavato, ottenendo così, un elevato comfort visivo dell'apparecchio.



Verschiedene Effekte für verschiedene Anforderungen Diversi effetti per tutte le installazioni

Mit Bat lassen sich unterschiedliche Effekte in den verschiedenen Versionen erzeugen. Der enge Lichtstrahl in der runden oder quadratischen Ausführung eignet sich perfekt für die Beleuchtung von Treppenhäusern. Der breite Lichtstrahl hingegen, den es auch in runder oder quadratischer Ausführung gibt, erfüllt die Beleuchtungsanforderungen in Durchgangsbereichen.

Bat ti permette di creare diversi effetti nelle sue diverse versioni. Il fascio stretto, in opzione tondo o quadrato, è perfetto per illuminare le scale. D'altra parte, l'ampio fascio luminoso, anche nella sua versione tonda o quadrata, risponde alle esigenze di illuminazione delle zone di transito.

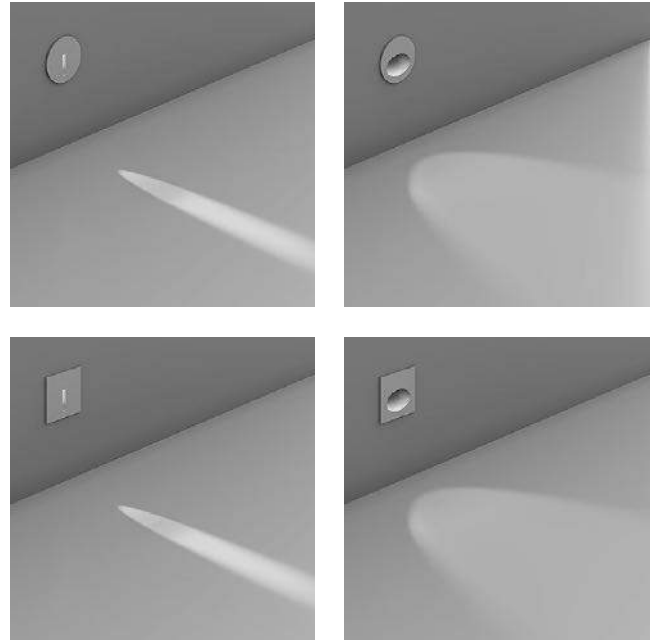

Einbauleuchte der Spitzenqualität Incasso di massima qualità



Bat wurde konzipiert, um die höchste auf dem Markt erhältliche Einbauqualität zu erreichen. Das Gehäuse besteht aus maschinell gefertigtem Aluminium und es verfügt über einen Glasdiffusor, welches die Lebensdauer des Produkts maximieren und seine Installation in feuchten Umgebungen oder sogar direkt am Meer ermöglichen. Zudem sind Flügel für die Installation in Rigipsplatten und spezielle Abdichtungsstopfen inbegriffen, um die Dichtigkeit und Zuverlässigkeit der Leuchte zu garantieren.

Bat è progettato per diventare l'incasso di miglior qualità del mercato. Il suo corpo è realizzato in alluminio lavorato e di un diffusore in vetro per massimizzare la vita utile del prodotto, permettendo la sua installazione in ambienti umidi o anche sul lungomare. Inoltre, comprende alette per l'installazione in cartongesso, insieme a premistoppa speciale antiapertura che garantiscono la tenuta e l'affidabilità dell'apparecchio.



BAT

IP	IK		SEA SIDE SUITABLE
66	10	1 m	

14  J6  Z5 

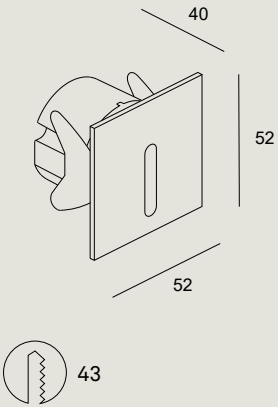

LED						
K	CRI	WLED	Real Lm	Optics	Code	
2700	80	2.2	11	Medium 26°	05-E017 - J6 - CK	14 Z5
3000	80	2.2	11	Medium 26°	05-E017 - J6 - CL	14 Z5
4000	80	2.2	11	Medium 26°	05-E017 - J6 - CM	14 Z5

 3V Max. 700mA

IP	IK		SEA SIDE SUITABLE
66	10	1 m	

14  J6  Z5 

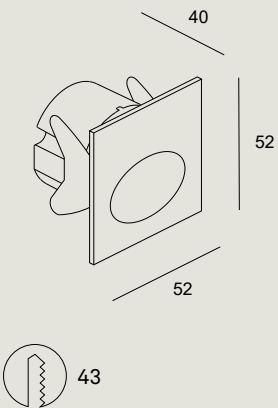

LED						
K	CRI	WLED	Real Lm	Optics	Code	
2700	80	2.2	45	Medium 40°	05-E016 - J6 - CK	14 Z5
3000	80	2.2	45	Medium 40°	05-E016 - J6 - CL	14 Z5
4000	80	2.2	45	Medium 40°	05-E016 - J6 - CM	14 Z5

 3V Max. 700mA

BAT

IP	IK		SEA SIDE
66	10	1 m	SUITABLE

14 J6 Z5

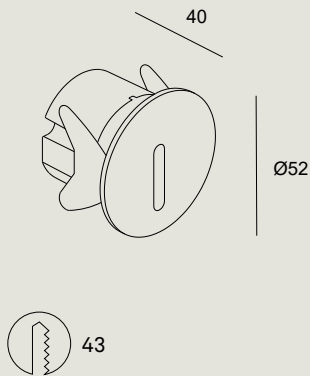

LED						
K	CRI	W LED	Real Lm	Optics	Code	
2700	80	2.2	11	Medium 26°	05-E015 - J6 - CK	14 Z5
3000	80	2.2	11	Medium 26°	05-E015 - J6 - CL	14 Z5
4000	80	2.2	11	Medium 26°	05-E015 - J6 - CM	14 Z5

3V Max. 700mA

IP	IK		SEA SIDE
66	10	1 m	SUITABLE

14 J6 Z5

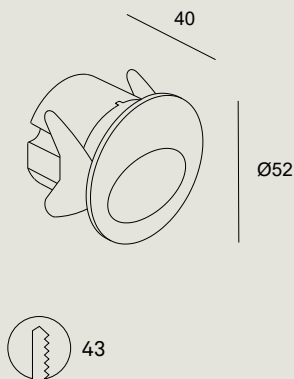

LED						
K	CRI	W LED	Real Lm	Optics	Code	
2700	80	2.2	45	Medium 40°	05-E014 - J6 - CK	14 Z5
3000	80	2.2	45	Medium 40°	05-E014 - J6 - CL	14 Z5
4000	80	2.2	45	Medium 40°	05-E014 - J6 - CM	14 Z5

3V Max. 700mA

05-E014 05-E015 05-E016 05-E017	IP		u. min	u. max		CODE
				220-240V	110-127V	
IP67	ON-OFF		2	4	4	71-E014-00-00
	DALI		1	14	7	71-E080-00-00
IP68	0-10V		1	8	7	71-E081-00-00
	ON-OFF		1	7	5	71-3308-00-00
IP20	DALI		1	8	6	71-6192-00-00
	0-10V		1	8	6	71-7710-00-00
Optional IP66 IK09 box (300x200x105mm)						71-E100-00-00

P 940

mitgeliefertes allgemeines Zub. Klemmen für Wandmontage
Access. comuni inclusi Morsetti per fissaggio a parete

nicht mitgeliefertes allgemeines Zub. Access. comuni non inclusi	IP68-Stecker mit 6 Eingängen Connettore IP68 a 6 ingressi	71-9199-05-05
	IP67-Stecker mit 3 Eingängen Connettore IP67 a 3 ingressi	71-9262-05-05
	Unterputzdose Scatola da incasso	71-E065-60-00
	IP68- Antikondensationsstecker mit 2 Eingängen Connettore IP68 con valvola anticondensa a 2 ingressi	71-E112-00-00

Sign

BODY MAT
AL



50000h
L80 B20

3
MacAdam

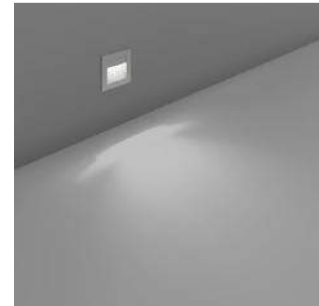

IP
20



14 ○

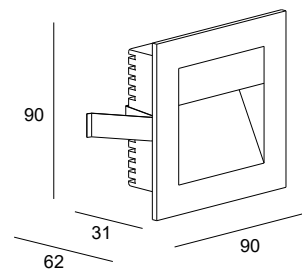

LED Max. 700mA 3V					
K	CRI	W LED	W Total	Real Lm	Code
3000	80	2.2	2.2	80	EP-0356 - 14 - 00
1x max. 22	1x max. 2	1x max. 9	1x max. 14	1x max. 8	
ON-OFF	ON-OFF	1-10V/PUSH	PHASE CUT 240V/PUSH	DALI/DALI2	
71-3542	71-7712	71-7710	71-4898	71-6192	

inklusive / Incluso

Unterputzdose
Cassetta da incasso

Secret

BODY MAT		50000h	3
PLSTER		L80 B20	MacAdam

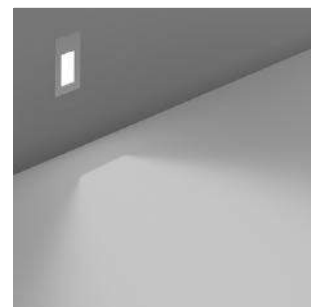

IP
20

14

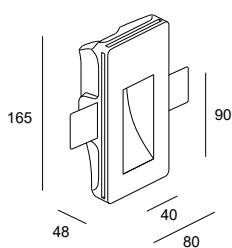

LED Max. 350mA 3V					
K	CRI	W LED	W Total	Real Lm	Code
3000	80	1	1	69	05-1804 - 14 - 00
1x max.25	1x max.2	1x max.15	1x max.16	1x max.15	
ON-OFF	ON-OFF	1-10V/PUSH	PHASE CUT 240V/PUSH	DALI/DALI2	
71-3542	71-8077	71-7710	71-4898	71-6192	

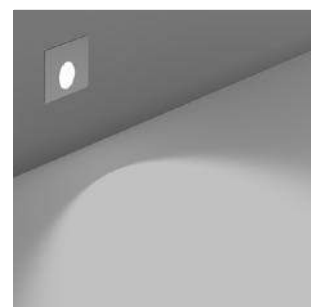
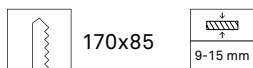

DIF MAT	IP
PC	20

14

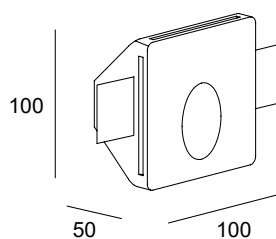

LED Max. 350mA 3V					
K	CRI	W LED	W Total	Real Lm	Code
3000	80	1	1	93	05-2904 - 14 - 00
1x max.25	1x max.2	1x max.15	1x max.16	1x max.15	
ON-OFF	ON-OFF	1-10V/PUSH	PHASE CUT 240V/PUSH	DALI/DALI2	
71-3542	71-8077	71-7710	71-4898	71-6192	

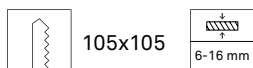

Step

BODY MAT
AL



50000h
L80 B20

3
MacAdam



IP	IK	 PHASE CUT
20	10	

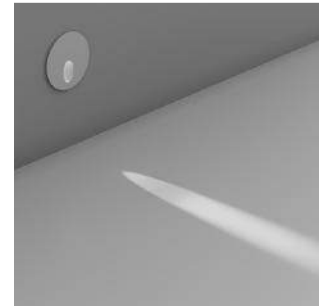

14 ○

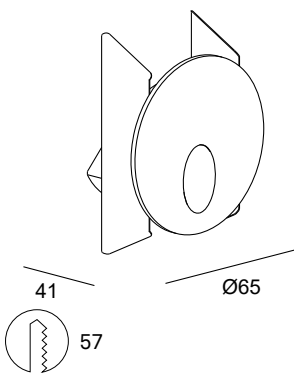

LED					
K	CRI	W LED	W Total	Real Lm	Code
3000	80	3.8	3.8	67	55-1573 - 14 - 00
220-240V		50-60Hz			



IP	 PHASE CUT
20	

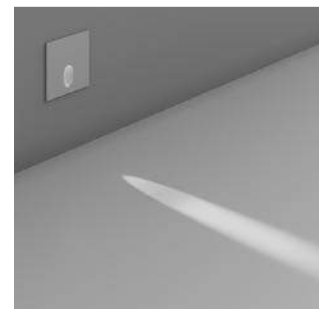

14 ○

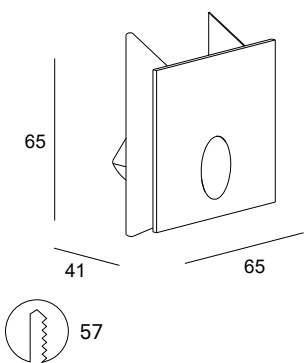

LED					
K	CRI	W LED	W Total	Real Lm	Code
3000	80	3.8	3.8	67	55-1574 - 14 - 00
220-240V		50-60Hz			

mitgeliefertes allgemeines Zub.
Access. comuni inclusi

Unterputzdose
Cassetta da incasso

— Lineare Beleuchtungssysteme

Sistemi lineari d'illuminazione



Infinite Pro

345

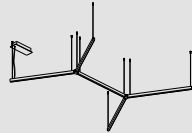

Apex

371

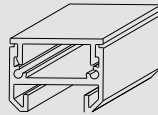

Lineal

388

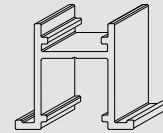

Taglio di Luce

393



Infinite Pro

BODY MAT	DIF MAT		50000h	3
AL	PC		L80 B20	MacAdam



Infinite Pro ist die perfekte Lösung für die Beleuchtung von Räumen, die ein hohes Maß an Komfort erfordern. Sie steigert das Wohlbefinden der Raumnutzer(innen) im häuslichen und betrieblichen Umfeld, insbesondere in Büros und Arbeitsbereichen, in denen die Lichtqualität von entscheidender Bedeutung ist. Es besteht aus der Verbindung zweier Elemente: Gehäuse und Inneneinheit. Die außergewöhnlich modular aufgebaute Kollektion bietet die Wahl zwischen einer der vier möglichen Installationen in drei lackierten Ausführungen und zwei aus schalldämmendem Material sowie einer der neun möglichen Inneneinheiten, die wiederum über unterschiedliche Leistungen, Diffusoren, Längen und Varianten mit integrierter Konnektivität und Notbeleuchtungsversionen verfügen. Dank der hohen Modularität dieser Kollektion ist es möglich, lineare Beleuchtung in jedem Raum anzubieten, ohne dass andere Leuchten, die das Beleuchtungskonzept beeinträchtigen, integriert werden müssen.

Infinite Pro è la soluzione perfetta per illuminare spazi che richiedono un elevato comfort, offrendo un'illuminazione concepita per migliorare il benessere delle persone e delle aziende, soprattutto in uffici o in spazi di lavoro in cui la qualità della luce assume un ruolo fondamentale. È costituita dalla combinazione di due elementi: struttura e nucleo. La collezione, di una modularità eccezionale, permette di scegliere tra una delle 4 installazioni possibili. Vengono proposte in 3 finiture verniciate e in 2 di materiale fonoassorbente, con uno dei 9 possibili nuclei di illuminazione che, a loro volta, forniscono diverse potenze, diffusori, lunghezze e versioni di connettività integrata e di emergenza. La grande modularità di questa collezione permette di offrire un'illuminazione lineare in qualsiasi spazio senza dover incorporare altri apparecchi che modifichino il concetto illuminotecnico.





SKY

Form und Aufbau Composizione e struttura

Das System besteht aus zwei Elementen: einem Gehäuse und einem Modul mit einer von neun möglichen Inneneinheiten, die sich an die spezifischen Anforderungen anpassen.

È costituita dalla combinazione di due elementi: una struttura e un modulo che può accogliere 9 possibili nuclei di luce con caratteristiche specifiche, per adattarsi a qualsiasi necessità.



Einfach- und Doppelstrahlung Mono e doppia emissione

Die Hängemodelle von Infinite Pro sind mit Einfach- und Doppelstrahlung erhältlich, um jedem Projekt gerecht zu werden. Nei modelli a sospensione, Infinite Pro offre l'opzione mono e doppia emissione per adattarsi a ogni progetto.

Installationsoptionen Opzioni di installazione

Eine Lösung für jedes Beleuchtungskonzept. Die Aufputzmodelle von Infinite Pro sind in Weiß, Schwarz und Grau lieferbar, die Unterputzmodelle in Weiß, die Hängemodelle in Weiß, Schwarz und Grau und die Leuchten für Niederspannungsschiene in Schwarz lieferbar. Zudem sind die Modelle in schalldämmender Ausführung erhältlich.

Una soluzione per ogni progetto illuminotecnico. Infinite Pro offre versioni da superficie in finiture bianca, nera e grigia, da incasso con finitura bianca, a sospensione con finiture bianca, nera e grigia e con opzione fonoassorbente e installazione su binario a bassa tensione, in finitura nera.



Aufbau
Superficie



Einbau
Incasso



Pendelmontage
Sospesa

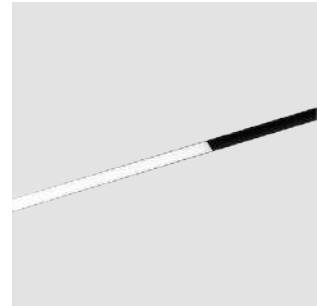

Niederspannungsschiene
Binario a basso voltaggio

Modul: Maximale Kontrolle und Effizienz Modulo: Massimo controllo ed efficienza

Infinite Pro wird mit Polycarbonat-Linsen hergestellt, um ein Höchstmaß an Kontrolle und Effizienz zu gewährleisten, und verfügt über CRI80. Außerdem bietet es eine große Auswahl an Modulen und Optiken, die für alle Projekte geeignet sind.

Infinite Pro è realizzata con lenti in policarbonato per massimizzare il controllo e l'efficienza, con un CRI80. Inoltre, dispone di un'ampia gamma di moduli e ottiche per adattarsi a tutti i progetti.

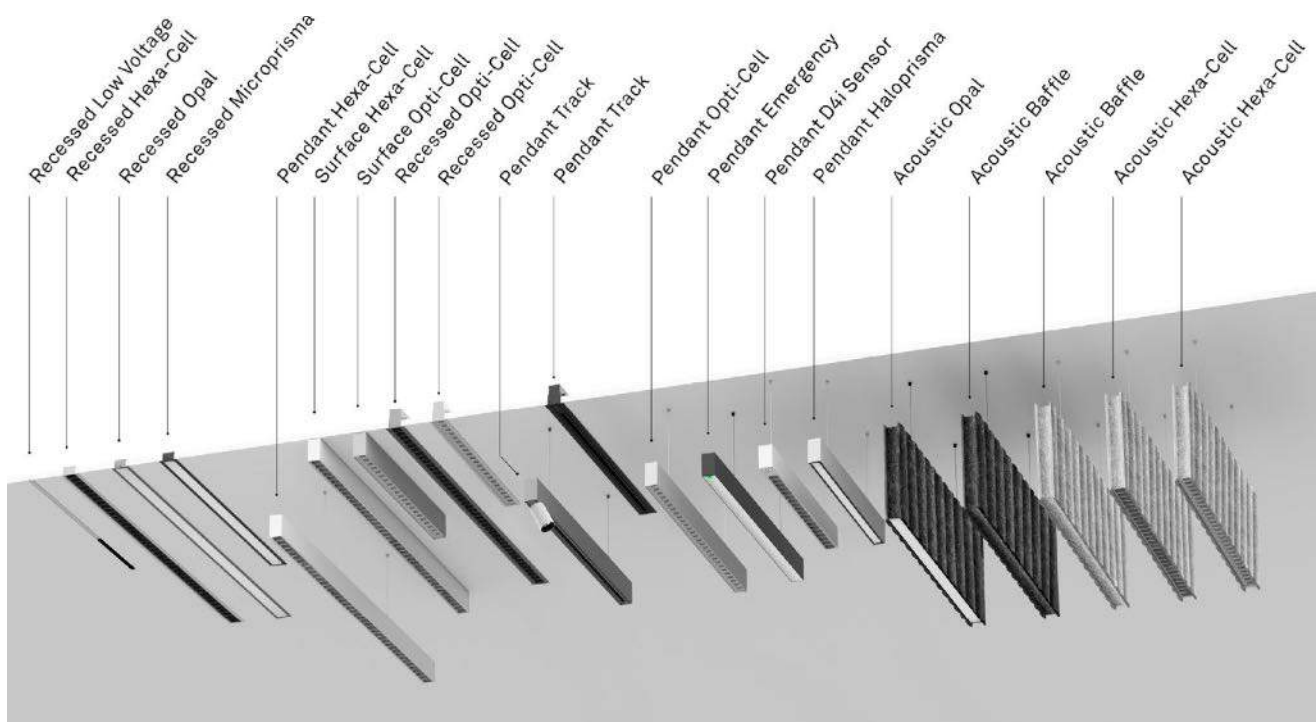

Linsen Lenti



Opal (UGR < 22)

Allgemeinbeleuchtungsmodul, das dank eines sehr gleichmäßigen Opaldiffusors eine einheitliche und komfortable Beleuchtung erzielt. Neben der hohen Leuchtkraft und der außergewöhnlichen Effizienz von *114lm/W weist das Modell einen Lichtaustrittswinkel von 100° auf und kann ist so für jede Raumaufteilung geeignet.

Modulo di luce generale che, grazie ad un diffusore opale ad alta uniformità, ottiene un effetto omogeneo e confortevole. Oltre al grande flusso in uscita e all'elevata efficienza *114lm/W dispone di un angolo di uscita della luce di 100°, il che significa che l'apparecchio può essere utilizzato in qualsiasi distribuzione di stanza.



Microprisma (UGR < 19)

Mikroprismatisches Lichtmodul. Durch den Einsatz einer transparenten, mikrogravierten Lösung werden zusätzliche Effizienz und Komfort erreicht. Diese Variante entspricht dem Leuchtenzertifizierungsprogramm YellowDot*.

Modulo di luce microrismatico. L'uso di una soluzione trasparente micro- incisa apporta maggiore efficienza e comfort all'insieme. Questa versione è inclusa nel programma di certificazione di apparecchi Yellowdot*.



Haloprism (UGR < 19)

Die Kombination aus einer speziell entwickelten Linse und einem Mikroprisma-Diffusor bietet eine Effizienz von *138lm/W mit einer hervorragenden Leuchtkraft von bis zu 2000 lm/m² bei einem **UGR<19. Die weiträumige Lichtverteilung sorgt für eine einheitliche Ausleuchtung der Arbeitsräume.

Grazie alla combinazione di una lente appositamente progettata e di un diffusore microprismatico otteniamo un'efficienza di *138lm/W, con un grande flusso di uscita fino a 2000 lumen per metro possibili con un **UGR<19. Insieme a un'ampia distribuzione della luce garantisce una perfetta omogeneità per ambienti di lavoro.



Hexa- Cell (UGR < 10)

Mithilfe dieses exklusiven sechseckigen Mikrozellen-Diffusors erreichen wir außergewöhnlichen Komfort und einen Dark Light-Effekt mit einem UGR < 10. Hexa-Cell ist die perfekte Lösung für Arbeitsbereiche, die der Norm UNE 12464-1 entsprechen sollen.

Grazie all'esclusivo diffusore a microcelle esagonali otteniamo un comfort eccezionale e un effetto Dark Light con un UGR 10. Hexa - Cell è la soluzione ideale per spazi di lavoro conformi alla normativa UNE 12464-1.



Opticell (UGR < 16)

Der Zellenkonstruktion in Verbindung mit der Linse bietet hervorragenden Lichtkomfort und einen ausgeprägten und diskreten „Darklight-Effekt“, sodass die Lichtquelle kaum wahrnehmbar ist. Darklight sorgt für ein natürlicheres Ambiente, da die künstliche Lichtquelle nicht zu sehen ist und somit eine dezenterere und harmonischere Beleuchtung erreicht wird. Auch diese Lampe zeichnet sich durch ein perfektes Gleichgewicht zwischen einem Austrittswinkel $>74^\circ$, einem UGR-Wert <16 und einer Lichtausbeute von 156lm/W aus. Das optische System ist auf maximalen Lichtkomfort und Gleichförmigkeit ausgelegt.

Con il suo design esclusivo a celle e l'uso di una lente otteniamo un comfort eccezionale e un effetto Dark Light, una luce così discreta dove la sorgente luminosa è appena visibile. Dark light definisce un ambiente più naturale, perché non è possibile vedere la sorgente luminosa artificiale, si crea così un'illuminazione più discreta e armoniosa. Quest'opzione presenta inoltre un perfetto equilibrio tra un angolo di uscita $>74^\circ$, un valore UGR <16 e un'efficienza di 156lm/W. Il suo sistema ottico appositamente progettato per ottenere il massimo benessere visivo e l'uniformità della luce.



90°-Linse (UGR < 22) **Lente a 90° (UGR < 22)**

Nach dem Zhaga-Standard gefertigte 90°-Linse. Linsen mit optimaler Kontrolle, geringer Blendung und höchster Präzision. Lente a 90° realizzata secondo lo standard di Zhaga. Lenti con un ottimo controllo, basso abbagliamento e massima precisione.



Wall Washer Linse (UGR < 16) **Lente Wall Washer (UGR < 16)**

Nach dem Zhaga-Standard gefertigte asymmetrische Wall Washer Linse. Erzeugt einen äußerst gleichmäßigen Wandflutungsseffekt und vermeidet dunkle Bereiche.

Lente wall washer asimmetrica realizzata secondo lo standard Zhaga. Crea un effetto wall washer a parete di alta omogeneità e con assenza di zone scure.



Oval-Linse (UGR < 19) **Lente Ovale (UGR < 19)**

Nach dem Zhaga-Standard gefertigte Oval-Linse. Speziell für Räume konzipiert, in denen das Licht ohne seitliche Beeinträchtigungen zentral abgegeben werden soll.

Lente con distribuzione ovale realizzata secondo lo standard Zhaga. Progettata specificamente per spazi che richiedono una distribuzione centrale senza interferenze laterali.



Batwing Linse (UGR < 22) **Lente Batwing (UGR < 22)**

Nach dem Zhaga-Standard gefertigte asymmetrische Batwing-Linse. Perfekt für lineare Beleuchtungslösungen, wie zum Beispiel im Einzelhandel.

Lente con effetto asimmetrico batwing realizzata secondo lo standard Zhaga. Ideale per distribuzioni lineari come lineari retail.



Track

Integration einer Dreiphasenschiene zur Installation von Strahlern.

Integrazione di un binario trifase per l'installazione di proiettori.

Easy-click-System Sistema easy-click

Mit dem Easy-Click-System lassen sich das Gehäuse und die Innen einheit schnell und ohne Werkzeug montieren.

Dispone di un sistema easy-click che facilita il montaggio della struttura e il nucleo, in modo veloce e senza strumenti.

Notfallversion Versione di emergenza

Bei der Notfallversion von Infinite Pro ist die Signal-LED in die Leuchte integriert, wodurch die Installation viel einfacher ist und keine zusätzlichen Bauteile benötigt werden.

Nella versione di emergenza di Infinite Pro il LED di segnalazione è incluso nello stesso apparecchio di illuminazione, rendendo l'installazione molto più semplice e senza la necessità di elementi aggiuntivi.

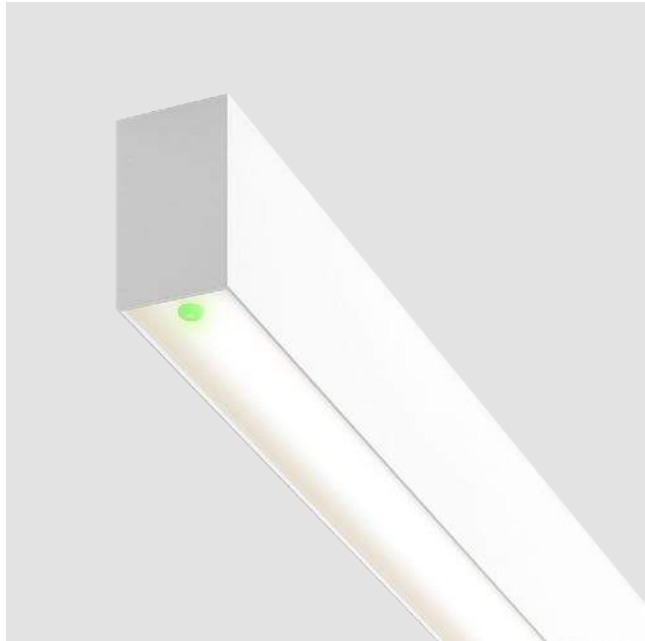

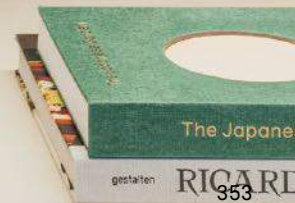

Infinite Pro Acoustic: Schalldämmende Materialien Materiali fonoassorbenti

Infinite Pro bietet Ausführungen mit schalldämmenden Materialien, die unangenehme Umgebungsgeräusche dämpfen können. Infinite Pro Acoustic ist in einer Einheitsgröße mit zwei Pendelvarianten erhältlich, eine mit Lichtkörper und die andere ohne Lichtquelle, mit dem Ziel, eine möglichst große Fläche mit dem Produkt abzudecken und so die angestrebte Schalldämpfung zu erreichen. Das schall gedämmte Modell von Infinite Pro ist mit intelligenter Technologie und Casambi ausgestattet, ist in Tunable White erhältlich und bietet eine Notfallversion. Die Inneneinheiten sind mit Opal-, Mikroprisma- oder Hexa-Cell-Diffusoren erhältlich.

Infinite Pro dispone di versioni realizzate con materiali fonoassorbenti in grado di attenuare il rumore generato in diversi ambienti e che può causare disagio. Infinite Pro Acoustic offre un'unica misura con due versioni sospese, una con un nucleo di luce e l'altra senza sorgente luminosa, pensate per coprire la maggior superficie possibile con il prodotto e soddisfare così l'obiettivo di attenuazione del suono. Il modello fonoassorbente di Infinite Pro è Smart con Casambi integrato, Tunable White ed è disponibile in versione di emergenza. I nuclei di luce disponibili sono Opal, Microprismatico ed Hexacell.

Rating according to ISO 11654: 1997 Weighted sound absorbing coefficient, $\alpha_w=0.95$ Sound absorption class: Class A

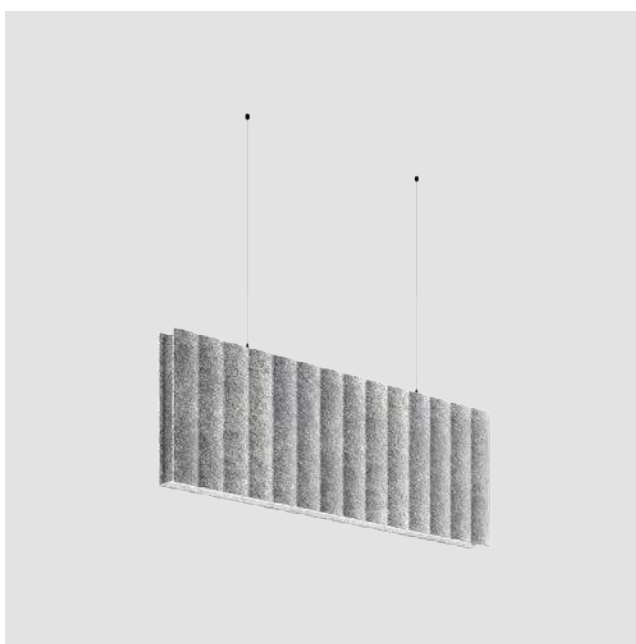
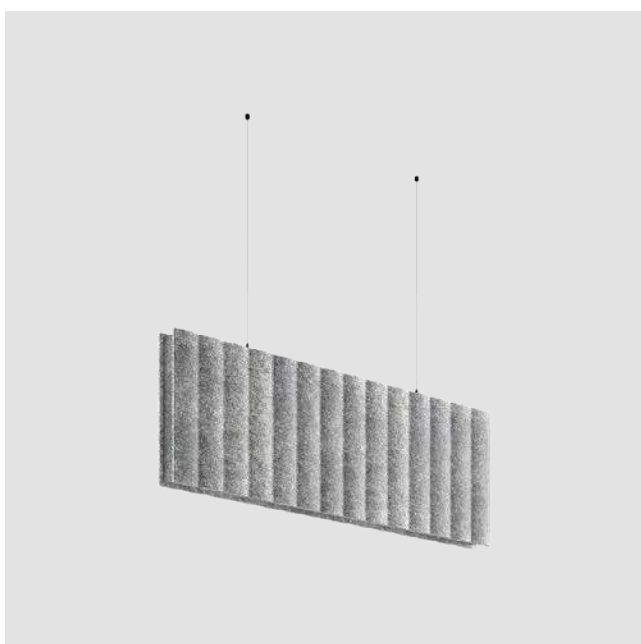
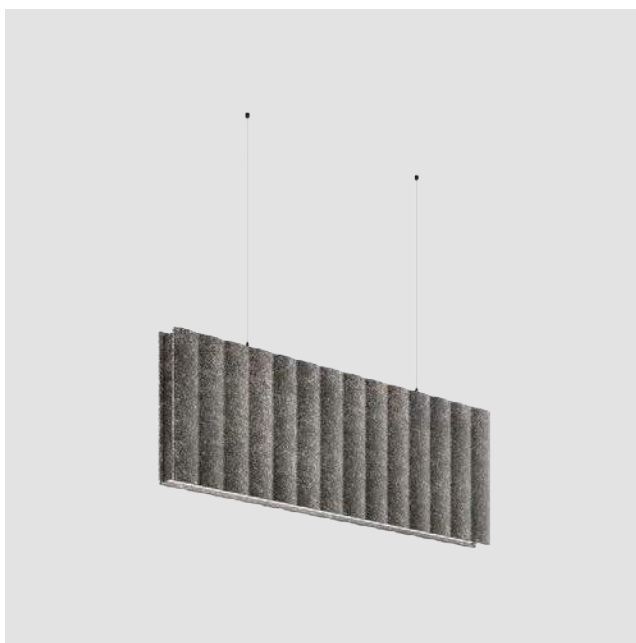
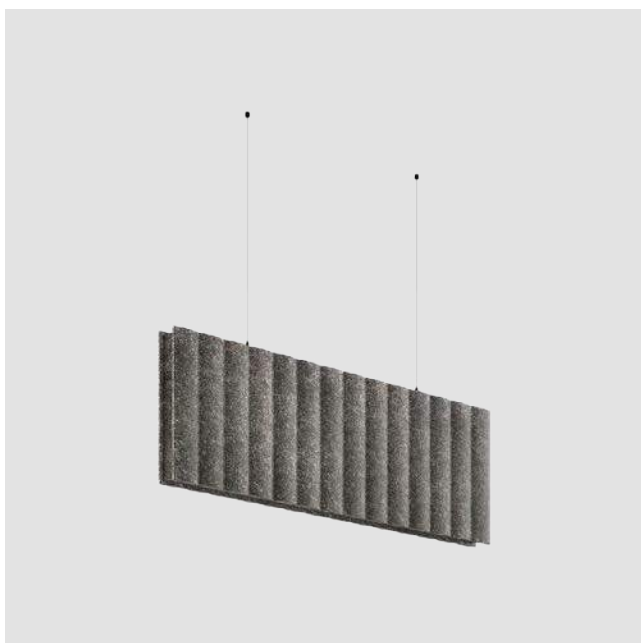

Tunable White

Infinite Pro bietet Varianten mit dynamisch steuerbarem Weißlicht nach dem Tunable White-Prinzip, mit dem sich die Farbtemperatur gezielt anpassen lässt oder Tageslicht simuliert werden kann.

Infinite Pro offre versioni in bianco dinamico Tunable White che permettono, tramite un sistema di controllo, di regolare la temperatura di colore in modo puntuale o di simulare la luce naturale.



Smart-Funktionen: Raummanagement Funzionalità Smart: Gestione degli spazi



Video ansehen
Guarda il video

Mithilfe der D4i-Technologie ist es möglich, die Raumbelegung zu überwachen und so die Raumauslastung zu maximieren, damit Räume je nach Situation und Bedarf angepasst und umverteilt werden können.

Grazie alla tecnologia D4i è possibile monitorare l'occupazione, con sentendo di massimizzare l'efficienza degli spazi, adattarli e ridistribuirli secondo le esigenze di ogni situazione e prendere decisioni in funzione delle esigenze delle persone.

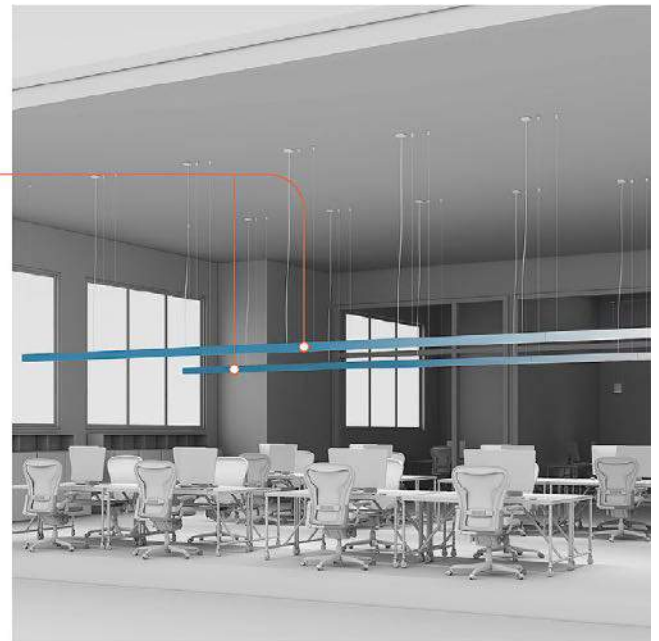

Smart

Mit der Kombination aus dem Infinite MultiSensor D4i-Zubehör und der D4i-Managementplattform verfügt die Anlage über das optimale Hilfsmittel für maximale Leistung in Sachen Energieeffizienz und Belegungsmanagement. INFINITE PRO ist außerdem in SMART Versionen mit Casambi-Technologie für Umgebungen erhältlich, in denen die Interaktion mit der Beleuchtung und eine einfache Integration des Steuerungssystems besonders wichtig sind. Einige Infinite-Produkte sind im Programm enthalten YellowDot Leuchtzertifizierung, die zertifiziert zu unseren Leuchten, für den Einsatz von Positioniertechnik drinnen.

La combinazione dell'Accessorio Infinite Multisensor D4i e della piattaforma di gestione D4i dota l'installazione di uno strumento che permette ottenere il massimo rendimento in termini di efficienza energetica e gestione dell'occupazione. INFINITE PRO dispone anche di versioni SMART Casambi per gli ambienti dove prevalgono le interazioni con l'illuminazione e la facilità di integrazione del sistema di controllo. Alcuni prodotti Infinite sono inclusi nel Programma Certificazione YellowDot Luminaire, che certifica ai nostri apparecchi, per l'utilizzo della tecnologia di posizionamento in casa.



Online-Konfigurator Configuratore online



Konfigurieren Sie Ihre Leuchte
Configura il tuo apparecchio

Bei Aufgaben, die hinsichtlich der Baulänge und Konstruktion eine spezielle Lösung erfordern, kann mit dem Konfigurator auf der LEDS C4-Website die Lösung entworfen werden, die am besten zum Projekt passt.

Per i progetti che richiedono specifiche soluzioni, sia di lunghezza che di design, il sito web LEDS C4 dispone di un configuratore che consente di disegnare la soluzione più adatta al progetto.

infinite.leds-c4.com

1. Auswahl der Installation

Selezione dell'installazione



2. Auswahl von Diffusor, LEDs und Ausführung

Selezione del diffusore, del LED e della finitura



3. Auswahl von Gehäuse, Form und Modulen

Sélection de la structure, de la forme et des modules



4. Abrufen von Code



Ottenere il codice



INFINITE PRO

854mm

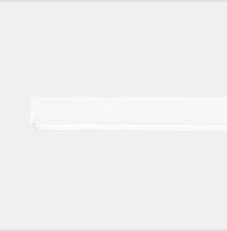
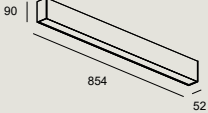
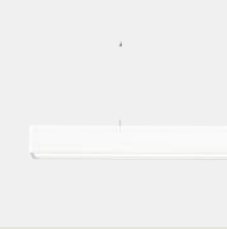
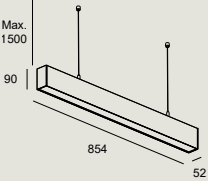

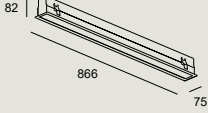
Codebeispiel / Esempio di codice: AK11-1PW8HPOS14

Model	W	K/ CRI/ Real lm	Optics	Source	Finishes		
AK11 - 854mm / Aufbau 854mm / Superficie  	1P 10W	W8 3000K/ CRI80/1739lm	HP Haloprisma	OS ON-OFF/220-240V/50-60Hz	14 60 NOT FOR AK13 N3 NOT FOR AK13		
		W9 3000K/ CRI90/1370lm				DS DALI/220-240V/50-60Hz	
		X8 4000K/ CRI80/1850lm				XB CASAMBI 220-240V 50-60Hz	
		X9 4000K/ CRI90/1426lm					
	12 12W	W8 3000K/ CRI80/1715lm	CL Opticell	OS ON-OFF 220-240V 50-60Hz			
		W9 3000K/ CRI90/1576lm		DS DALI 220-240V 50-60Hz			
		X8 4000K/ CRI90/1576lm					
		X9 4000K/ CRI90/1576lm					
AK12 - 854mm / Pendelmontage 854mm / sospesa  	15 15W	W8 3000K/ CRI80/609lm(HC) - 1748lm(PM)	HC Hexa-Cell	OS ON-OFF 220-240V 50-60Hz			
		W9 3000K/ CRI90/480lm(HC) - 1377lm(PM)			PM Opal	DS DALI 220-240V 50-60Hz	
		X8 4000K/ CRI80/648lm(HC) - 1860lm(PM)					
		X9 4000K/ CRI90/499lm(HC) - 1433lm(PM)					
	24 24W	W8 3000K/ CRI80/3381lm	CL Opticell	OS ON-OFF/220-240V/50-60Hz			
		W9 3000K/ CRI90/3043lm		DS DALI/220-240V 50-60Hz			
		X8 4000K/ CRI80/3530lm		WR D4i/220-240V 50-60Hz			
		X9 4000K/ CRI90/3043lm		XB CASAMBI 220-240V 50-60Hz			
AK13 - 854mm / Einbau 854mm / Incasso 860x65  	26 26W	W8 3000K/ CRI80/984lm(HC) - 2944lm(PM)	HC Hexa-Cell	OS ON-OFF 220-240V 50-60Hz			
		W9 3000K/ CRI90/879lm(HC) - 2629lm(PM)			PM Opal	DS DALI/220-240V 50-60Hz	
		X8 4000K/ CRI80/1047lm (HC) - 3132lm(PM)					WR D4i/220-240V 50-60Hz
		X9 4000K/ CRI90/807lm(HC) - 2414lm(PM)					
	18 18W	U8 TW 2700K-6500K /CRI80/2630lm	CL Opticell	TW DALI DT8 220-240V 50-60Hz			
				XC CASAMBI + TW 220-240V 50-60Hz			
	26 26W	U8 TW 2700K-6500K /CRI80/ 1012lm(HC) - 2904lm(PM)	HC Hexa-Cell	TW DALI DT8 220-240V 50-60Hz			
				PM Opal	XA D4i + TW 220-240V 50-60Hz		
			XC CASAMBI + TW 220-240V 50-60Hz				





Nicht inklusive / Non incluso			
AK11	OS XB XC	Zubehör für Installation an der Wand Accessorio per installazione parete	14 71-7518-60-00 N3
		I-Verbindungsset Kit unione I	71-7519-00-00
		90°-Verbindungsstück Unione 90°	14 71-8113-60-00 N3
	DS TW WR XA	Zubehör für Installation an der Wand Accessorio per installazione parete	14 71-7518-60-00 N3
		Sensor DALI D4i One  Sensore DALI D4i One	14 71-A263-60-SE N3
		Sensor DALI D4i Connected  Sensore DALI D4i Connected	14 71-7735-60-SE N3
		I-Verbindungsset DALI Kit unione I DALI	71-7519-00-DA
		90°-Verbindungsstück DALI Unione 90° DALI	14 71-8113-60-DA N3
		DALI-Verbindungsset Kit unione DALI	71-8246-00-DA
		AK12	OS XB XC
I-Verbindungsset Kit unione I	71-7519-00-00		
90°-Verbindungsstück Unione 90°	14 71-8113-60-00 N3		
DS TW WR XA	Sensor DALI D4i One  Sensore DALI D4i One		14 71-A263-60-SE N3
	Hänge-Fleuron mit Stromanschluss DALI Rosone sospeso presa di corrente DALI		14 71-7521-60-00 N3
	Sensor DALI D4i Connected  Sensore DALI D4i Connected		14 71-7735-60-SE N3
	I-Verbindungsset DALI Kit unione I DALI		71-7519-00-DA
	90°-Verbindungsstück DALI Unione 90° DALI		14 71-8113-60-DA N3
	DALI-Verbindungsset Kit unione DALI		71-8246-00-DA
	AK13		OS XB XC
90°-Verbindungsstück Unterputz Rahmen Unione 90° incasso cornice		71-8112-14-00	
DS TW WR XA		I-Verbindungsset DALI Kit unione I DALI	71-7519-00-DA
		90°-Verbindungsstück DALI Unterputz Rahmen Unione 90° DALI incasso cornice	71-8112-14-DA
		DALI-Verbindungsset Kit unione DALI	71-8246-00-DA
		AK11 AK12 AK13	Mikroprisma-Diffusor Diffusore microprismatico

INFINITE PRO

1136mm

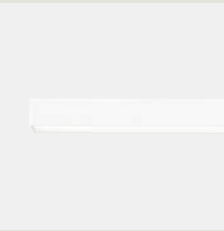
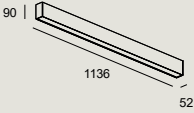

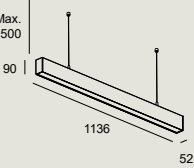
Codebeispiel / Esempio di codice: AK14-13W8HPOS14

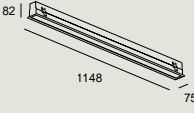









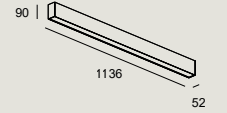



Model	W	K/ CRI/ Real lm	Optics	Source	Finishes		
AK14 - 1136mm / Aufbau 1136mm / Superficie 	13 13W	W8 3000K/ CRI80/2264lm	HP Haloprisma	OS ON-OFF/220-240V/50-60Hz DS DALI/220-240V 50-60Hz WR D4i/220-240V 50-60Hz XB CASAMBI 220-240V/50-60Hz	14 60 NOT FOR AK16 N3 NOT FOR AK16		
		W9 3000K/ CRI90/1783lm					
		X8 4000K/ CRI80/2409lm					
		X9 4000K/ CRI90/1856lm					
	16 16W	W8 3000K/ CRI80/2280lm	CL Opticell	OS ON-OFF 220-240V/50-60Hz DS DALI 220-240V/50-60Hz			
		W9 3000K/ CRI90/2052lm					
		X8 4000K/ CRI80/2381lm					
		X9 4000K/ CRI90/2052lm					
AK15 - 1136mm / Pendelmontage 1136mm / Sospesa 	2P 20W	W8 3000K/ CRI80/790lm (HC) - 2276lm (PM)	HC Hexa-Cell PM Opal	OS ON-OFF 220-240V/50-60Hz OU ON-OFF 100-277V/50-60Hz DS DALI 220-240V/50-60Hz			
		W9 3000K/ CRI90/623lm (HC) - 1793lm (PM)					
		X8 4000K/ CRI80/841lm (HC) - 2422lm (PM)					
		X9 4000K/ CRI90/648lm (HC) - 1866lm (PM)					
	32 32W	W8 3000K/ CRI80/4402lm	CL Opticell	OS ON-OFF 220-240V/50-60Hz OU ON-OFF 100-277V/50-60Hz DS DALI 220-240V/50-60Hz WR D4i 220-240V/50-60Hz XB CASAMBI 220-240V/50-60Hz			
		W9 3000K/ CRI90/3962lm					
		X8 4000K/ CRI80/4596lm					
		X9 4000K/ CRI90/3962lm					
AK16 - 1136mm / Einbau 1136mm / Incasso 	34 34W	W8 3000K/ CRI80/1290lm (HC) - 3834lm (PM)	HC Hexa-Cell PM Opal	OS ON-OFF 220-240V/50-60Hz OU ON-OFF 100-277V/50-60Hz DS DALI 220-240V/50-60Hz WR D4i 220-240V/50-60Hz XB CASAMBI 220-240V/50-60Hz O3 EMERGENCY ON-OFF 3H 220-240V/50-60Hz D3 EMERGENCY DALI 3H 220-240V/50-60Hz			
		W9 3000K/ CRI90/1152lm (HC) - 3424lm (PM)					
		X8 4000K/ CRI80/1373lm (HC) - 4079lm (PM)					
		X9 4000K/ CRI90/1058lm (HC) - 3143lm (PM)					
	24 24W	U8 TW 2700K - 6500K / CRI80/3424lm	CL Opticell	TW DALI DT8 220-240V/50-60Hz XA D4i + TW 220-240V/50-60Hz XC CASAMBI + TW 220-240V/50-60Hz			
		35 35W			U8 TW 2700K - 6500K / CRI80/1347lm (HC) - 3877lm (PM)	HC Hexa-Cell PM Opal	TW DALI DT8 220-240V/50-60Hz XA D4i + TW 220-240V/50-60Hz XC CASAMBI + TW 220-240V/50-60Hz
		24 24W			U8 TW 2700K - 6500K / CRI80/3424lm		
		35 35W			U8 TW 2700K - 6500K / CRI80/1347lm (HC) - 3877lm (PM)		



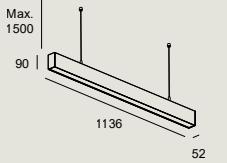

INFINITE PRO

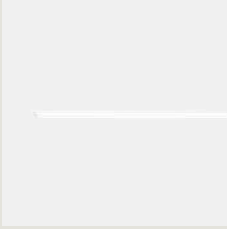
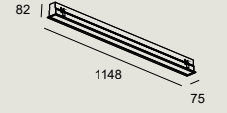
WELL

1136mm Lens

Codebeispiel / Esempio di codice: AK14-2PW8R2OS14

Model	W	K/ CRI/ Real lm	Optics	Source	Finishes
 	2P 20W	W8 3000K/ CRI80/2342lm (R2)	R2 Wall Washer	OS  ON-OFF/220- 240V/50-60Hz	14  60  NOT FOR AK16 N3  NOT FOR AK16
		W9 3000K/ CRI90/2069lm (B2)	B2 Batwing	OU  ON-OFF/100- 277V/50-60Hz	
		X8 3000K/ CRI80/2818lm (L9)	L9 Lens 90°	DS  DALI/220- 240V/50-60Hz	
		X9 4000K/ CRI90/2285lm (E2)	E2 Eliptic		
 	34 34W	W8 3000K/ CRI80/4162lm (R2)	R2 Wall Washer	OS  ON-OFF/220- 240V/50-60Hz	
		W9 3000K/ CRI90/3822lm (B2)	B2 Batwing	OU  ON-OFF/100- 277V/50-60Hz	
		X8 4000K/ CRI80/4611lm (L9)	L9 Lens 90°	DS  DALI/220- 240V/50-60Hz	
		X9 4000K/ CRI90/3513lm (E2)	E2 Eliptic		
 	AA	CC	NA Track	BU  P. 940	

Nicht inklusive / Non incluso			
AK14	OS OU XB XC	Zubehör für Installation an der Wand Accessorio per installazione parete	14 71-7518-60-00 N3
		I-Verbindungsset Kit unione I	71-7519-00-00
		90°-Verbindungsstück Unione 90°	14 71-8113-60-00 N3
	DS TW WR XA	Zubehör für Installation an der Wand Accessorio per installazione parete	14 71-7518-60-00 N3
		Sensor DALI D4i One  Sensore DALI D4i One	14 71-A263-60-SE N3
		Sensor DALI D4i Connected  Sensore DALI D4i Connected	14 71-7735-60-SE N3
		I-Verbindungsset DALI Kit unione I DALI	71-7519-00-DA
		90°-Verbindungsstück DALI Unione 90° DALI	14 71-8113-60-DA N3
		DALI-Verbindungsset Kit unione DALI	71-8246-00-DA
AK15	OS OU XB XC	Hänge-Fleuron mit Stromanschluss Rosone sospeso presa di corrente	14 71-7520-60-00 N3
		I-Verbindungsset Kit unione I	71-7519-00-00
		90°-Verbindungsstück Unione 90°	14 71-8113-60-00 N3
	DS TW WR XA	Sensor DALI D4i One  Sensore DALI D4i One	14 71-A263-60-SE N3
		Hänge-Fleuron mit Stromanschluss DALI Rosone sospeso presa di corrente DALI	14 71-7521-60-00 N3
		Sensor DALI D4i Connected  Sensore DALI D4i Connected	14 71-7735-60-SE N3
		I-Verbindungsset DALI Kit unione I DALI	71-7519-00-DA
		90°-Verbindungsstück DALI Unione 90° DALI	14 71-8113-60-DA N3
		DALI-Verbindungsset Kit unione DALI	71-8246-00-DA
O3	Betriebsgerät für Infinite Pro Emergency Alimentatore per Infinite Pro Emergency	14 71-A223-60-00 N3	
D3	Betriebsgerät DALI für Infinite Pro Emergency Alimentatore DALI per Infinite Pro Emergency	14 71-A228-60-00 N3	
AK16	OS OU XB XC	I-Verbindungsset Kit unione I	71-7519-00-00
		90°-Verbindungsstück Unterputz Rahmen Unione 90° incasso cornice	71-8112-14-00
	DS TW WR XA	I-Verbindungsset DALI Kit unione I DALI	71-7519-00-DA
		90°-Verbindungsstück DALI Unterputz Rahmen Unione 90° DALI incasso cornice	71-8112-14-DA
		DALI-Verbindungsset Kit unione DALI	71-8246-00-DA
AK14 AK15 AK16	Mikroprisma-Diffusor Diffusore microprismatico	71-A938-00-00	

INFINITE PRO

1136mm Acoustic

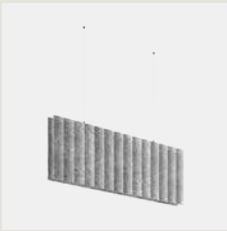
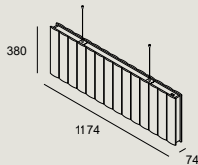

Codebeispiel / Esempio di codice: AK23-13W8HPOSGA

Model	W	K/ CRI/ Real lm	Optics	Source	Finishes
AK23 - 1136mm / Pendelmontage / Akustikleuchte 1136mm / Sospesa / Acustica	13 13W	W8 3000K/ CRI80/2264lm	HP Haloprisma	OS ON-OFF 220-240V/50-60Hz	GA GB
		W9 3000K/ CRI90/1783lm		DS DALI/220-240V 50-60Hz	
		X8 4000K/ CRI80/2409lm		WR (SC) D4i/220-240V 50-60Hz	
		X9 4000K/ CRI90/1856lm		XB (S) CASAMBI 220-240V/50-60Hz	
 	32 31W	W8 3000K/ CRI80/4402lm	CL Opticell	OS ON-OFF 220-240V/50-60Hz	
		W9 3000K/ CRI90/3962lm		OU ON-OFF 100-277V/50-60Hz	
		X8 4000K/ CRI80/4596lm		DS DALI 220-240V/50-60Hz	
		X9 4000K/ CRI90/3962lm		WR (SC) D4i 220-240V/50-60Hz XB (S) CASAMBI 220-240V/50-60Hz	
34 34W	W8 3000K/ CRI80/1290lm (HC) - 3834lm (PM)	HC Hexa-Cell	PM Opal	OS ON-OFF 220-240V/50-60Hz	
				W9 3000K/ CRI90/1152lm (HC) - 3424lm (PM)	OU ON-OFF 100-277V/50-60Hz
				X8 4000K/ CRI80/1373lm (HC) - 4079lm (PM)	DS DALI 220-240V/50-60Hz
				X9 4000K/ CRI90/1058lm (HC) - 3143lm (PM)	WR (SC) D4i 220-240V/50-60Hz XB (S) CASAMBI 220-240V/50-60Hz O3 EMERGENCY ON-OFF 3H 220-240V/50-60Hz D3 EMERGENCY DALI 3H 220-240V/50-60Hz
24 24W	U8 TW 2700K - 6500K /CRI90/3424lm	CL Opticell	TW DALI DT8 220-240V/50-60Hz XC (S) CASAMBI + TW 220-240V/50-60Hz		
35 35W	U8 TW 2700K - 6500K /CRI80/1347lm (HC) - 3877lm (PM)	HC Hexa-Cell PM Opal	TW DALI DT8 220-240V/50-60Hz XA (SC) D4i + TW 220-240V/50-60Hz XC (S) CASAMBI + TW 220-240V/50-60Hz		
AA GU10	BF	NA Baffle	BU P. 940		

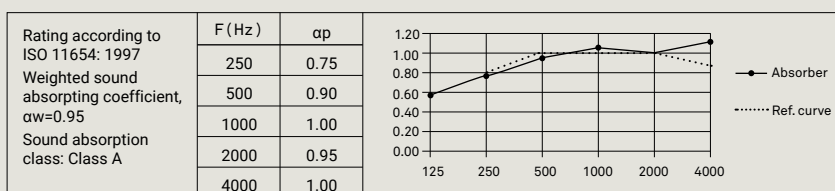

nicht inklusive / Non incluso

Mikroprisma-Diffusor 71-A938-00-00
 Diffusore microprismatico

INFINITE PRO



1136mm Up&Down

Codebeispiel / Esempio di codice: AK24-13WBHPOS14

Model	W	K/ CRI/ Real lm		Optics	Source	Finishes
AK24 - 1136mm Pendelmontage / Up&Down 1136mm Sospesa / Up&Down	13 13W	UP	DOWN	HP Haloprisma	OS ON-OFF/220-240V/50-60Hz DS DALI/220-240V/50-60Hz WR D4i/220-240V/50-60Hz 	14 60 N3
		WB 3000K/ CRI80	3000K/ CRI90			
		XB 4000K/ CRI80	4000K/ CRI90			
		QB 3000K/ CRI80	4000K/ CRI90			
		RB 4000K/ CRI80	3000K/ CRI90			
	16 16W	WB 3000K/ CRI80	3000K/ CRI90	CL Opticell	OS ON-OFF/220-240V/50-60Hz DS DALI/220-240V/50-60Hz	
		XB 4000K/ CRI80	4000K/ CRI90			
		QB 3000K/ CRI80	4000K/ CRI90			
		RB 4000K/ CRI80	3000K/ CRI90			
	2P 20W	WB 3000K/ CRI80	3000K/ CRI90	HC Hexa-Cell	OS ON-OFF/220-240V/50-60Hz	
		XB 4000K/ CRI80	4000K/ CRI90			
		QB 3000K/ CRI80	4000K/ CRI90	PM Opal	OU ON-OFF/100-277V/50-60Hz	
		RB 4000K/ CRI80	3000K/ CRI90		DS DALI/220-240V/50-60Hz	
	32 31W	WB 3000K/ CRI80	3000K/ CRI90	CL Opticell	OS ON-OFF/220-240V/50-60Hz OU ON-OFF/100-277V/50-60Hz DS DALI/220-240V/50-60Hz WR D4i/220-240V/50-60Hz 	
		XB 4000K/ CRI80	4000K/ CRI90			
		QB 3000K/ CRI80	4000K/ CRI90			
		RB 4000K/ CRI80	3000K/ CRI90			
	34 34W	WB 3000K/ CRI80	3000K/ CRI90	HC Hexa-Cell	OS ON-OFF/220-240V/50-60Hz OU ON-OFF/100-277V/50-60Hz	
		XB 4000K/ CRI80	4000K/ CRI90			
		QB 3000K/ CRI80	4000K/ CRI90	PM Opal	DS DALI/220-240V/50-60Hz	
		RB 4000K/ CRI80	3000K/ CRI90		WR D4i/220-240V/50-60Hz 	
	24 24W	U8 TW 2700K - 6500K/ CRI80	TW 2700K - 6500K/ CRI80	CL Opticell	TW DALI DT8/220-240V/50-60Hz	
	35 25W	U8 TW 2700K - 6500K/ CRI80	TW 2700K - 6500K/ CRI80	HC Hexa-Cell PM Opal	XA D4i + TW/220-240V/50-60Hz TW DALI DT8/220-240V/50-60Hz	

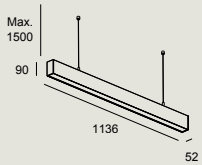







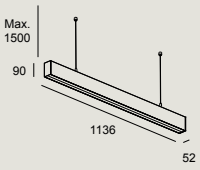

INFINITE PRO

1136mm Up&Down Lens

IP	WELL
40	

Codebeispiel / Esempio di codice: AK24-16WBNAOS14

Model	W	K/ CRI/ Real Im		Optics	Source	Finishes		
 <p>AK24 - 1136mm / Pendelmontage / Up&Down 1136mm / Sospesa / Up&Down</p> 	16 16W	WB	UP	DOWN	NA No reflector	OS  ON-OFF/220-240V/50-60Hz	14  60  N3 	
			Track	Track				
		XB	4000K/ CRI80	4000K/ CRI80				
			2P 20W	WB				3000K/ CRI80
	XB	4000K/ CRI80			4000K/ CRI90	B2 Batwing		
		QB		3000K/ CRI80	4000K/ CRI90	L9 Lens 90°	OU  ON-OFF/100-277V/50-60Hz	
	34 34W			WB	3000K/ CRI80	3000K/ CRI90		R2 Wall Washer
		XB	4000K/ CRI80		4000K/ CRI90	B2 Batwing		
			QB	3000K/ CRI80	4000K/ CRI90	L9 Lens 90°	OU  ON-OFF/100-277V/50-60Hz	
		RB		4000K/ CRI80	3000K/ CRI90	E2 Eliptic		



Nicht inklusive / Non incluso			
AK24	OS OU XB XC	Zubehör für Installation an der Wand Accessorio per installazione parete	14 71-7518-60-00 N3
		Hänge-Fleuron mit Stromanschluss Rosone sospeso presa di corrente	14 71-7520-60-00 N3
		I-Verbindungsset Kit unione I	71-7519-00-00
		90°-Verbindungsstück Up&Down Unione 90° Up&Down	14 71-8114-60-00 N3
	DS TW WR XA	Zubehör für Installation an der Wand Accessorio per installazione parete	14 71-7518-60-00 N3
		Sensor Up&Down DALI D4i One  Sensore Up&Down DALI D4i One	14 71-A264-60-SE N3
		Hänge-Fleuron mit Stromanschluss DALI Rosone sospeso presa di corrente DALI	14 71-7521-60-00 N3
		Sensor Up&Down DALI D4i Connected  Sensore Up&Down DALI D4i Connected	14 71-7736-60-SE N3
		I-Verbindungsset DALI Kit unione I DALI	71-7519-00-DA
		90°-Verbindungsstück DALI Up&Down Unione 90° DALI Up&Down	14 71-8114-60-DA N3
		DALI-Verbindungsset Kit unione DALI	71-8246-00-DA



INFINITE PRO

1700mm

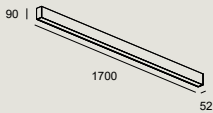
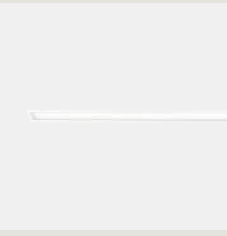
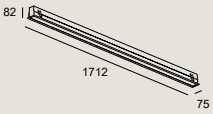

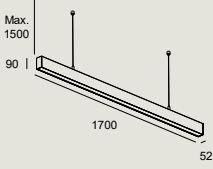
Codebeispiel / Esempio di codice: AK18-19W8HPOS14

Model	W	K/ CRI/ Real lm	Optics	Source	Finishes
AK18 - 1700mm / Aufbau 1700mm / Superficie  	19 19W	W8 3000K/ CRI80/2264lm	HP Haloprisma	OS ON-OFF/220-240V/50-60Hz	14 60 NOT FOR AK19 N3 NOT FOR AK18
		W9 3000K/ CRI90/1783lm		DS DALI/220-240V/50-60Hz	
		X8 4000K/ CRI80/2409lm		WR D4i/220-240V/50-60Hz 	
		X9 4000K/ CRI90/1856lm		XB CASAMBI /220-240V/50-60Hz 	
	24 24W	W8 3000K/ CRI80/3502lm	CL Opticell	OS ON-OFF/220-240V/50-60Hz	
		W9 3000K/ CRI90/3152lm		DS DALI/220-240V/50-60Hz	
		X8 4000K/ CRI80/3657lm			
		X9 4000K/ CRI90/3152lm			
AK19 - 1700mm / Einbau 1700mm / Incasso  1705x65 IP44 	3P 30W	W8 3000K/CRI80/1197lm (HC) – 3496lm (PM)	HC Hexa-Cell	OS ON-OFF/220-240V/50-60Hz	
		W9 3000K/CRI90/943lm (HC) – 2753lm (PM)		PM Opal	DS DALI/220-240V/50-60Hz
		X8 4000K/CRI80/1274lm (HC) – 3720lm (PM)			
		X9 4000K/CRI90/982lm (HC) – 2866lm (PM)			
	48 48W	W8 3000K/ CRI80/6762lm	CL Opticell		OS ON-OFF/220-240V/50-60Hz
		W9 3000K/ CRI90/6086lm		DS DALI/220-240V/50-60Hz	
		X8 4000K/ CRI80/7060lm		XB CASAMBI /220-240V/50-60Hz 	
		X9 4000K/ CRI90/6086lm			
AK21 - 1700mm / Pendelmontage 1700mm / Sospensa  	52 52W	W8 3000K/CRI80/1965lm (HC) – 5888lm (PM)	HC Hexa-Cell	OS ON-OFF/220-240V/50-60Hz	
		W9 3000K/CRI90/1755lm (HC) – 5258lm (PM)		PM Opal	DS DALI/220-240V/50-60Hz
		X8 4000K/CRI80/2091lm (HC) – 6264lm (PM)			WR D4i/220-240V/50-60Hz
		X9 4000K/CRI90/1611lm (HC) – 4827lm (PM)			XB CASAMBI /220-240V/50-60Hz
	36 36W	U8 TW 2700K - 6500K/CRI80/ 5259lm	CL Opticell		OS ON-OFF/220-240V/50-60Hz
				DS DALI DT8/220-240V/50-60Hz	
				XC CASAMBI + TW/220-240V/50-60Hz 	
				O3 EMERGENCY ON-OFF 3H/220-240V/50-60Hz	
	53 53W	U8 2024lm/CRI80/ (HC) – 5909lm (PM)	HC Hexa-Cell	OS ON-OFF/220-240V/50-60Hz	
				DS DALI DT8/220-240V/50-60Hz	
				XA D4i + TW/220-240V/50-60Hz 	
				XC CASAMBI + TW/220-240V/50-60Hz 	

Nicht inklusive / Non incluso			
AK18	OS OU XB XC	Zubehör für Installation an der Wand Accessorio per installazione parete	14 71-7518-60-00 N3
		I-Verbindungsset Kit unione I	71-7519-00-00
		90°-Verbindungsstück Unione 90°	14 71-8113-60-00 N3
	DS TW WR XA	Zubehör für Installation an der Wand Accessorio per installazione parete	14 71-7518-60-00 N3
		Sensor DALI D4i One  Sensore DALI D4i One	14 71-A263-60-SE N3
		Sensor DALI D4i Connected  Sensore DALI D4i Connected	14 71-7735-60-SE N3
		I-Verbindungsset DALI Kit unione I DALI	71-7519-00-DA
		90°-Verbindungsstück DALI Unione 90° DALI	14 71-8113-60-DA N3
		DALI-Verbindungsset Kit unione DALI	71-8246-00-DA
		DALI-Verbindungsset Kit unione DALI	71-8246-00-DA
AK19	OS XB XC	I-Verbindungsset Kit unione I	71-7519-00-00
		90°-Verbindungsstück Unterputz Rahmen Unione 90° incasso cornice	71-8112-14-00
	DS TW WR XA	I-Verbindungsset DALI Kit unione I DALI	71-7519-00-DA
		90°-Verbindungsstück DALI Unterputz Rahmen Unione 90° DALI incasso cornice	71-8112-14-DA
		DALI-Verbindungsset Kit unione DALI	71-8246-00-DA
AK21	OS OU XB XC	Hänge-Fleuron mit Stromanschluss Rosone sospeso presa di corrente	14 71-7520-60-00 N3
		I-Verbindungsset Kit unione I	71-7519-00-00
		90°-Verbindungsstück Unione 90°	14 71-8113-60-00 N3
	DS TW WR XA	Sensor DALI D4i One  Sensore DALI D4i One	14 71-A263-60-SE N3
		Hänge-Fleuron mit Stromanschluss DALI Rosone sospeso presa di corrente DALI	14 71-7521-60-00 N3
		Sensor DALI D4i Connected  Sensore DALI D4i Connected	14 71-7735-60-SE N3
		I-Verbindungsset DALI Kit unione I DALI	71-7519-00-DA
		90°-Verbindungsstück DALI Unione 90° DALI	14 71-8113-60-DA N3
		DALI-Verbindungsset Kit unione DALI	71-8246-00-DA
		DALI-Verbindungsset Kit unione DALI	71-8246-00-DA
	O3 D3	Betriebsgerät für Infinite Pro Emergency Alimentatore per Infinite Pro Emergency	14 71-A223-60-00 N3
		Betriebsgerät DALI für Infinite Pro Emergency Alimentatore DALI per Infinite Pro Emergency	14 71-A228-60-00 N3
	AK18 AK19 AK21	Mikroprisma-Diffusor Diffusore microprismatico	71-A938-00-00

INFINITE PRO

1700mm Up&Down

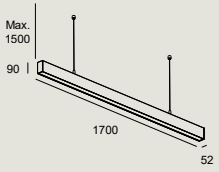

Codebeispiel / Esempio di codice: AK25-19WBHPOS14

Model	W	K/ CRI/ Real lm		Optics	Source	Finishes	
AK25 - 1700mm / Pendelmontage Up&Down 1700mm / Sospesa Up&Down  	19 19W		UP	DOWN	HP Haloprisma	OS ON-OFF/220-240V/50-60Hz DS DALI/220-240V/50-60Hz WR D4i/220-240V/50-60Hz XB CASAMBI /220-240V 50-60Hz	14 60 N3
		WB	3000K/ CRI80	3000K/ CRI90			
		XB	4000K/ CRI80	4000K/ CRI90			
		QB	3000K/ CRI80	4000K/ CRI90			
	24 24W	WB	3000K/ CRI80	3000K/ CRI90	CL Opticell	OS ON-OFF/220-240V/50-60Hz	
		XB	4000K/ CRI80	4000K/ CRI90			
		QB	3000K/ CRI80	4000K/ CRI90		DS DALI/220-240V/50-60Hz	
		RB	4000K/ CRI80	3000K/ CRI90			
	3P 30W	WB	3000K/ CRI8	3000K/ CRI90	HC Hexa-Cell	OS ON-OFF/220-240V/50-60Hz	
		XB	4000K/ CRI80	4000K/ CRI90			
		QB	3000K/ CRI80	4000K/ CRI90	PM Opal	DS DALI/220-240V/50-60Hz	
		RB	4000K/ CRI80	3000K/ CRI90			
48 48W	WB	3000K/ CRI80	3000K/ CRI90	CL Opticell	OS ON-OFF/220-240V/50-60Hz		
	XB	4000K/ CRI80	4000K/ CRI90				
	QB	3000K/ CRI80	4000K/ CRI90		DS DALI/220-240V/50-60Hz		
	RB	4000K/ CRI80	3000K/ CRI90				XB CASAMBI /220-240V/50-60Hz
52 52W	WB	3000K/ CRI80	3000K/ CRI90	HC Hexa-Cell	OS ON-OFF/220-240V/50-60Hz		
	XB	4000K/ CRI80	4000K/ CRI90				
	QB	3000K/ CRI80	4000K/ CRI90	PM Opal	WR D4i/220-240V/50-60Hz		
	RB	4000K/ CRI80	3000K/ CRI90		XB CASAMBI /220-240V/50-60Hz		
36 36W	U8	TW 2700K - 6500K/ CRI80	TW 2700K - 6500K/ CRI80	CL Opticell	TW DALI DT8/220-240V/50-60Hz		
					XC CASAMBI + TW/220-240V/50-60Hz		
53 53W	U8	TW 2700K - 6500K/ CRI80	TW 2700K - 6500K/ CRI80	HC Hexa-Cell	TW DALI DT8/220-240V/50-60Hz		
					PM Opal		XA D4i + TW/220-240V/50-60Hz
							XC CASAMBI + TW/220-240V/50-60Hz

Nicht inklusive / Non incluso			
AK25	OS OU XB XC	Zubehör für Installation an der Wand Accessorio per installazione parete	14 71-7518-60-00 N3
		Hänge-Fleuron mit Stromanschluss Rosone sospeso presa di corrente	14 71-7520-60-00 N3
		I-Verbindungsset Kit unione I	71-7519-00-00
		90°-Verbindungsstück Up&Down Unione 90° Up&Down	14 71-8114-60-00 N3
	DS TW WR XA	Zubehör für Installation an der Wand Accessorio per installazione parete	14 71-7518-60-00 N3
		Sensor Up&Down DALI D4i One  Sensore Up&Down DALI D4i One	14 71-A264-60-SE N3
		Hänge-Fleuron mit Stromanschluss DALI Rosone sospeso presa di corrente DALI	14 71-7521-60-00 N3
		Sensor Up&Down DALI D4i Connected  Sensore Up&Down DALI D4i Connected	14 71-7736-60-SE N3
		I-Verbindungsset DALI Kit unione I DALI	71-7519-00-DA
		90°-Verbindungsstück DALI Up&Down Unione 90° DALI Up&Down	14 71-8114-60-DA N3
		DALI-Verbindungsset Kit unione DALI	71-8246-00-DA
	AK25	Mikroprisma-Diffusor Diffusore microprismatico	71-A938-00-00



Apex

BODY MAT		50000h	3
AL		L80 B20	MacAdam

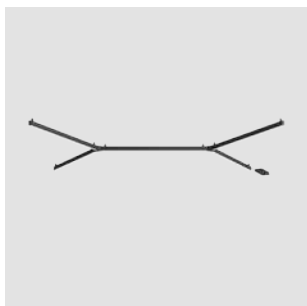

Räume kommunizieren durch die Komposition ihrer Elemente. Apex ist eine lineare Lösung, die sich durch ihrer hohe Kompositionsfähigkeit und vielfältige Anwendungsmöglichkeiten an diverse Raumgestaltungen anpasst. Die Aufbauten können recht einfach sein und mit einer einzigen Lichtquelle auskommen, oder durch Verkettung des Leuchtensystems verschiedene geometrische Figuren bilden.

Gli spazi comunicano attraverso la composizione dei suoi elementi. Apex è una soluzione lineare che si adatta a vari ambienti, grazie alla sua capacità compositiva e alla diversità delle sue applicazioni. Le sue costruzioni possono essere semplici, con un'unica sorgente luminosa, o complesse, con figure geometriche formate dalla concatenazione del suo sistema.



Konstruktive Elemente Elementi costruttivi

Apex besteht aus einem Profil in schwarzer oder weißer Ausführung sowie verschiedenen Knotenpunkten, mit denen der Designer Strukturen erstellen kann, die für jeden Bedarf das richtige Lichtmuster bieten. Die Profile können sowohl linear (1, 2 und 3 Meter lang) oder auch bogenförmig sein. Die Knotenpunkte sind mit 4 bzw. 6 Steckverbindungen erhältlich, womit die Profile in den gewünschten Formen zusammengesetzt werden können.

Apex si configura attraverso un profilo, disponibile nei colori bianco e nero, e vari nodi per comporre strutture che consentono al progettista di creare diversi modelli per ogni necessità. Da una parte, il profilo può essere lineare (nelle lunghezze 1, 2 e 3 metri) o a forma di arco. Dall'altra, Apex dispone di vari nodi con strutture fino a 4 e 6 incastraggi che uniscono i profili per ottenere le forme desiderate.

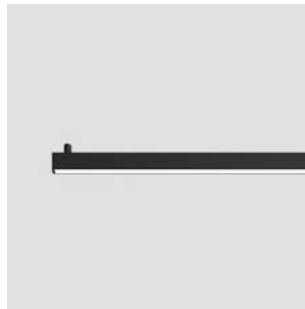

Gerades Profil
Profilo lineare



Kreisprofil
Profilo ad arco

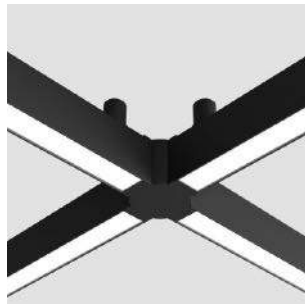

4er Kreuz
Nodo a 4

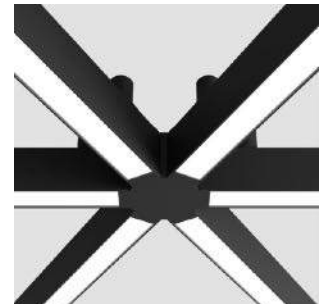

6er Kreuz
Nodo a 6

**Die richtige Optik
für jeden Bedarf**
Un'ottica per ogni
esigenza

Die linearen Optionen verfügen über Opal-Optiken für diffuses Licht mit einem UGR > 16, ideal für Arbeitsräume, und Bento mit einem kontrollierten Öffnungswinkel von 52° sowie eine Spot-Option zur Fokussierung des Lichts. Die Arco-Option verfügt über eine Opal-Optik.

Le opzioni lineari dispongono di ottiche Opal per ottenere una luce diffusa con un UGR > 16, ideale per spazi di lavoro, Bento, con un angolo controllato di apertura di 52° e un'opzione Spot per focalizzare la luce. L'opzione Arco dispone di ottica Opal.

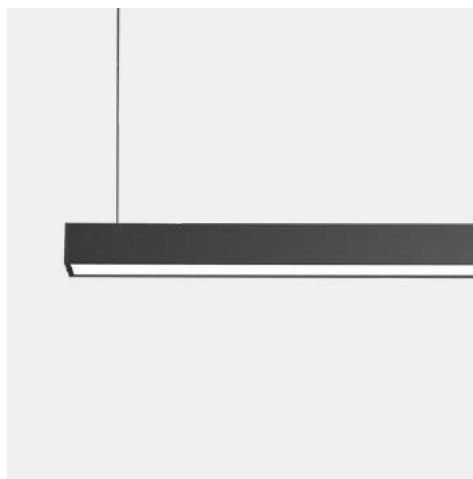

Opal (UGR>16)



Bento (UGR>16)



Spot

Installation und Vielseitigkeit Installazione e versatilità

Apex kann je nach den Projektanforderungen und dem zu gestaltenden Raumumfeld im Auf- oder hängend installiert werden. Bei beiden Einbaumöglichkeiten sind die Knotenpunkte die Schlüsselemente, um entweder in der Standardoption oder mit unserem Online-Konfigurator die gewünschten Formen zu bilden.

Apex può essere sospesa o installata in superficie, in base alle esigenze del progetto e del tipo di ambiente da lavorare. In entrambi i casi, i nodi agiscono da elemento chiave per ottenere le forme desiderate, sia in opzioni standard che nelle soluzioni ottenute con il nostro configuratore online.

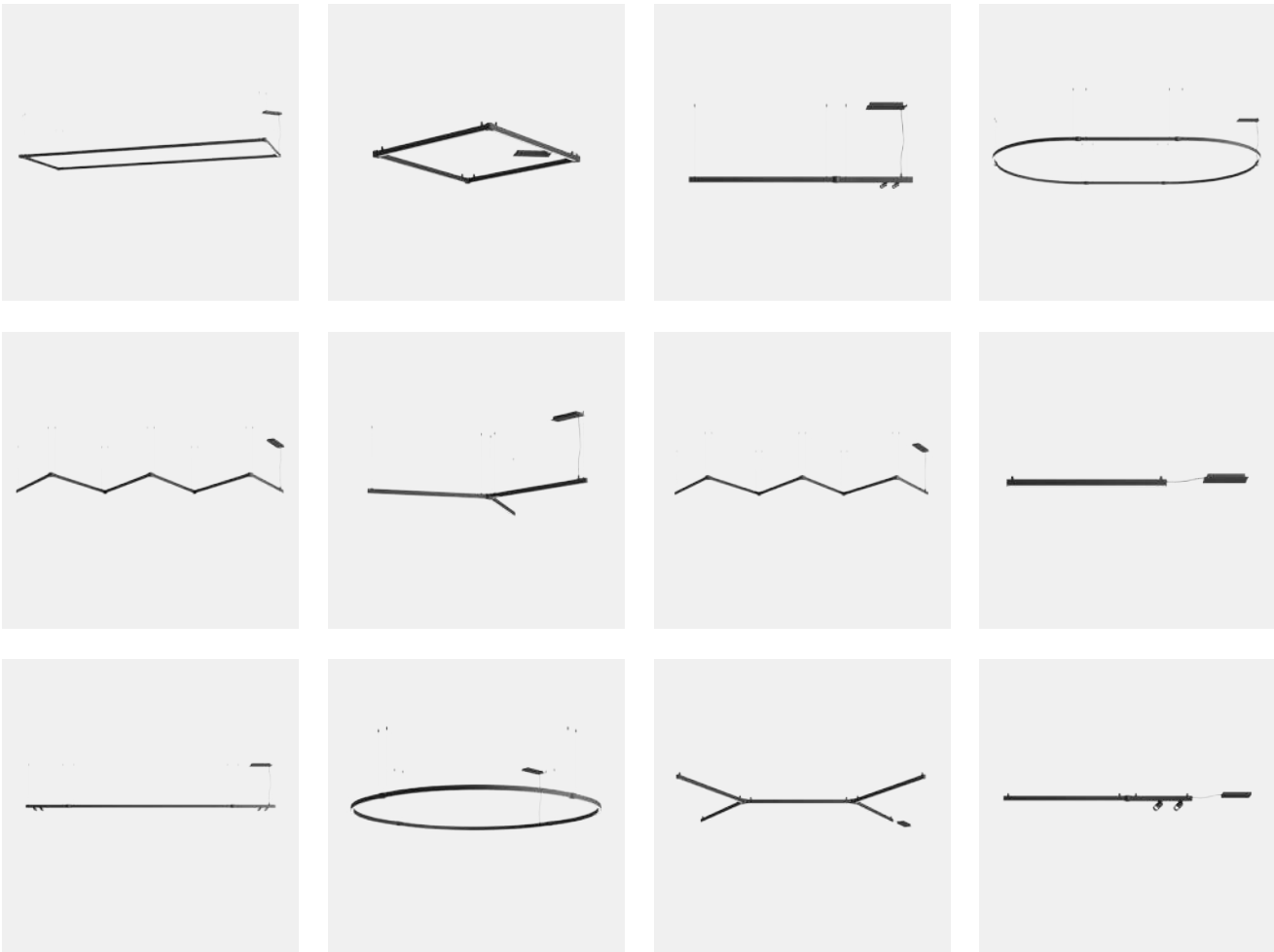

Smart

Apex EX ist in Versionen mit eingebauter Casambi Bluetooth Mesh-Technologie erhältlich, um Räume mit wechselnden Anforderungen flexibel zu gestalten.

Apex dispone di versioni con tecnologia Casambi Bluetooth Mesh incorporata, il che consente di aumentare la flessibilità degli spazi in ambienti con esigenze mutevoli.

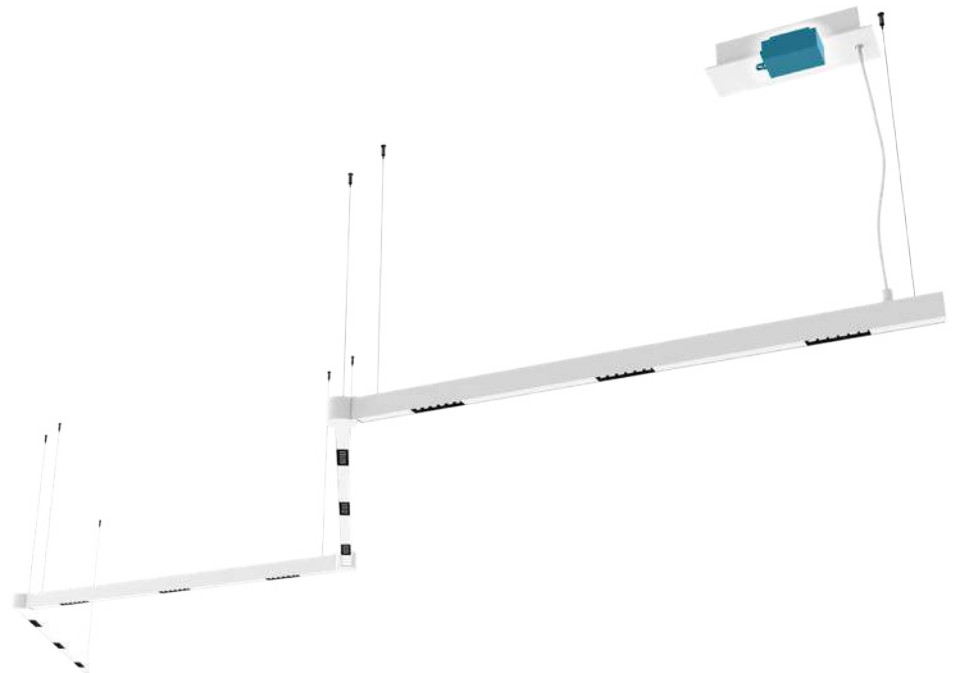

Smart-Funktionen: Lichtatmosphären Funzionalità Smart: Atmosfera luminosa

Als eine der Funktionalitäten der Smart-Technologie des modularen Apex-Systems besteht die Möglichkeit, die Lichtstärke je nach Raumnutzung und momentanem Ausleuchtungsbedarf zu regulieren und so mehr Flexibilität und Dynamik zu bieten.

Una delle funzionalità della tecnologia Smart nel sistema modulare Apex consiste nella possibilità di regolare il livello luminoso in base all'uso dello spazio e alle esigenze luminose di ciascun momento, offrendo così una maggiore flessibilità e più dinamismo.

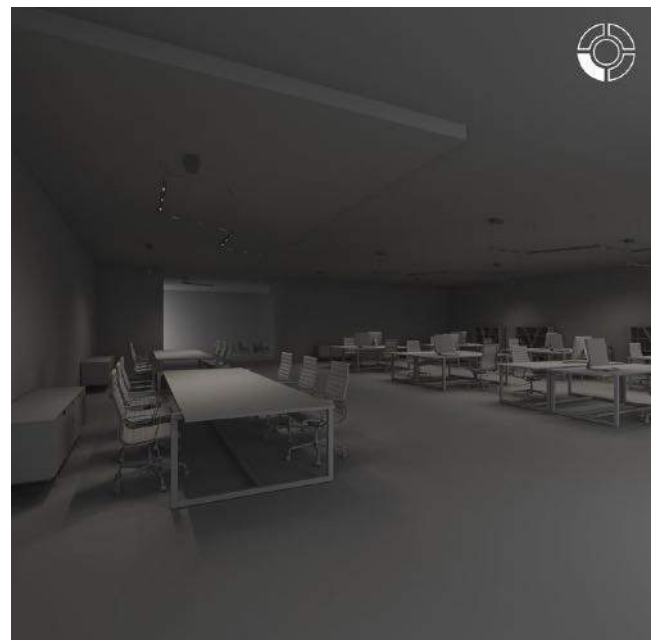

Online-Konfigurator Configuratore online



Konfigurieren Sie Ihre Leuchte
Configura il tuo apparecchio

Mit dem Online-Konfigurator von LEDS C4 lassen sich auf praktische und effektive Weise Leuchten zusammenstellen, die ganz auf das jeweilige Projekt zugeschnitten sind. Grazie allo strumento di configurazione online di LEDS C4 è possibile creare, in modo pratico ed efficace, un apparecchio di illuminazione completamente adattato ad ogni progetto.

apex.leds-c4.com



1. Auswahl der Standardform
Selezione della forma standard

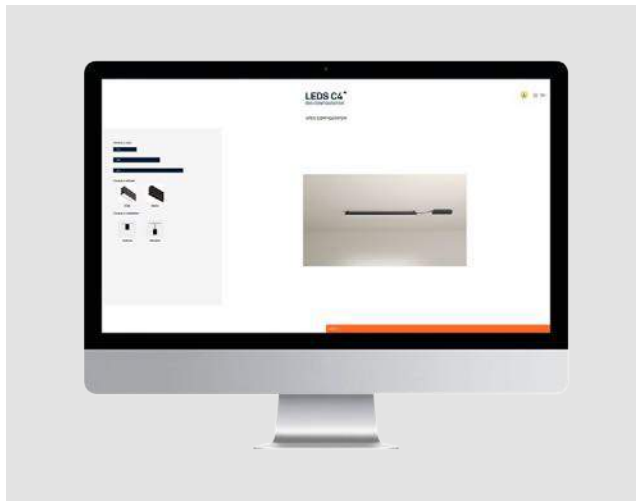

2. Auswahl von Größe, Diffusor und der Installation
Selezione di dimensione, diffusore e installazione

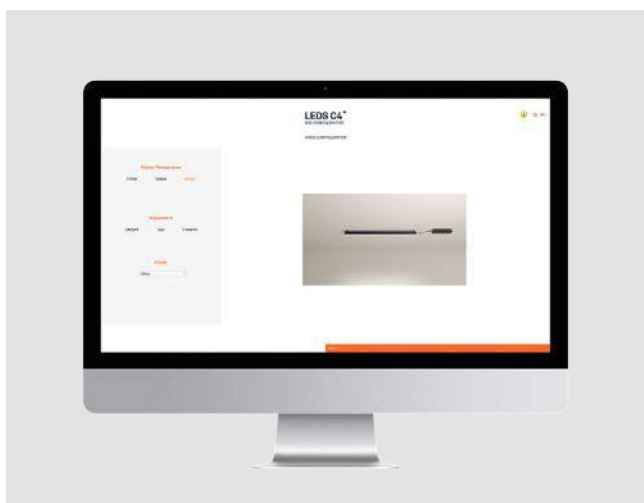

3. Auswahl von Farbtemperatur, Einstellung und Ausführung
Selezione della temperatura colore, regolazione e finitura

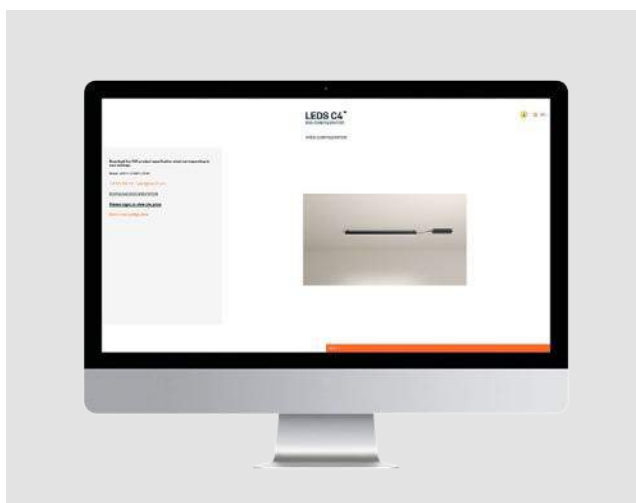

4. Download der Dokumentation
Scaricare documentazione

Custom



Benutzerdefinierte Auswahl
Selezione Custom



Auswahl von Installation, Farbtemperatur, Einstellung und Ausführung (benutzerdefiniert)
Selezione di installazione, temperatura colore, regolazione e finitura (custom)

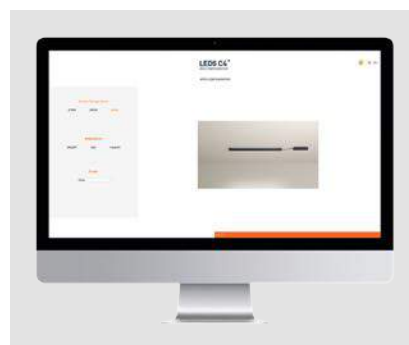

Erstellung einer benutzerdefinierten Form
Creazione forma Custom

APEX











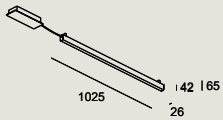





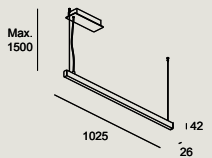

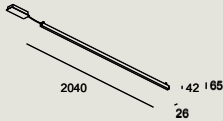

Lineal Simple

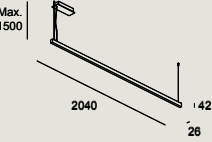

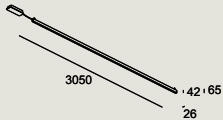
3
MacAdam

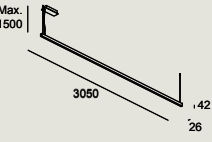

Codebeispiel / Esempio di codice: AW11-12VAPLOS14

Model	W	K/ CRI/ Real lm	Optics	Source	Finishes
 <p>AW11 - Lineal / Aufputz / 1025mm Lineal / Superficie / 1025mm</p>	12 12W	VA 2700K/CRI90/ 1042 lm	PL Opal	OS  ON-OFF/ 220-240V/50-60Hz	14  60 
		WA 3000K/CRI90/ 1042 lm		DS  DALI/220-240V/ 50-60Hz	
		XA 4000K/CRI90/ 1042 lm		XB  CASAMBI/ 220-240V/ 50-60Hz	
 <p>AW14 - Lineal / Hängend / 1025mm Lineal / Sospesa / 1025mm</p>	18 18W	V9 2700K/CRI90/ 1563 lm	BE Bento 52°		
		W9 3000K/CRI90/ 1563 lm			
		X9 4000K/CRI90/ 1563 lm			
 <p>AW12 - Lineal / Aufputz / 2040mm Lineal / Superficie / 2040mm</p>	24 24W	VA 2700K/CRI90/ 2084 lm	PL Opal	OS  ON-OFF/ 220-240V/50-60Hz	
		WA 3000K/CRI90/ 2084 lm		DS  DALI/220-240V/ 50-60Hz	
		XA 4000K/CRI90/ 2084 lm		XB  CASAMBI/ 220-240V/ 50-60Hz	
 <p>AW15 - Lineal / Hängend / 2040mm Lineal / Sospesa / 20040mm</p>	36 36W	V9 2700K/CRI90/ 3126 lm	BE Bento 52°		
		W9 3000K/CRI90/ 3126 lm			
		X9 4000K/CRI90/ 3126 lm			
 <p>AW13 - Lineal / Aufputz / 3050mm Lineal / Superficie / 3050mm</p>	36 36W	VA 2700K/CRI90/ 3126 lm	PL Opal	OS  ON-OFF/ 220-240V/50-60Hz	
		WA 3000K/CRI90/ 3126 lm		DS  DALI/220-240V/ 50-60Hz	
		XA 4000K/CRI90/ 3126 lm		XB  CASAMBI/ 220-240V/50-60Hz	
 <p>AW16 - Lineal / Hängend / 3050mm Lineal / Sospesa / 3050mm</p>	54 54W	V9 2700K/CRI90/ 4689 lm	BE Bento 52°		
		W9 3000K/CRI90/ 4689 lm			
		X9 4000K/CRI90/ 4689 lm			

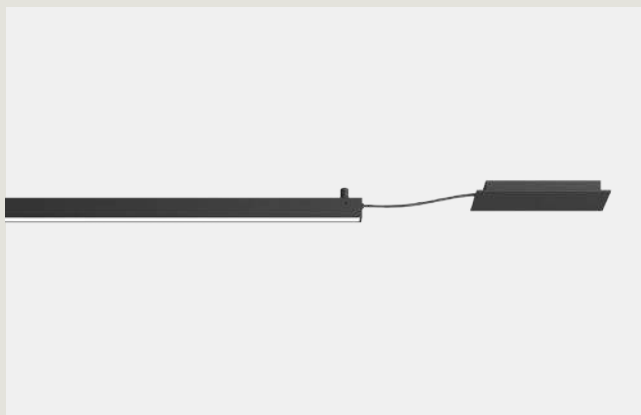

Installation oberfläche
Installazione in superficie

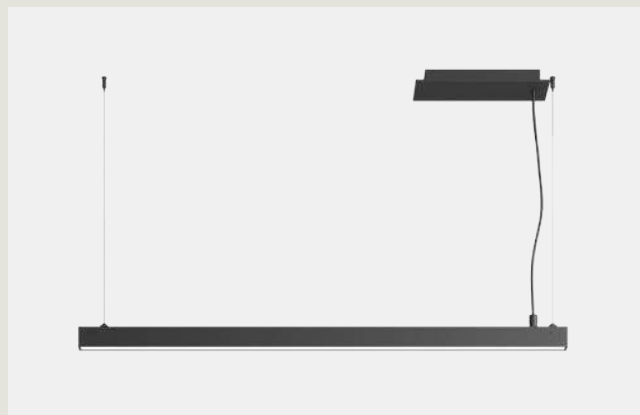

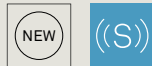

Installation hängend
installazione in sospensione

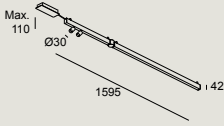

Lineal Double Spot Small

Codebeispiel / Esempio di codice: AW42-18VAPLOS14

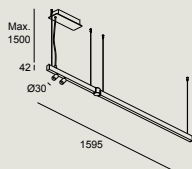
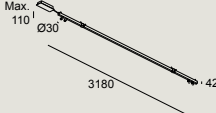
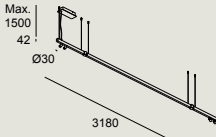
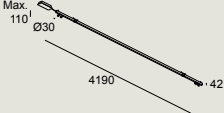
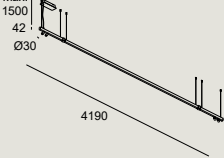









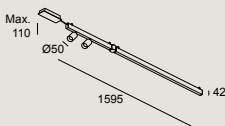



Model	W	K/ CRI/ Real lm	Optics	Source	Finishes
 <p>AW42 - Lineal / Aufputz / 1595mm / 2 Spots 30mm Lineal / Superficie / 1595mm / 2 Spots 30mm</p>	18 18W	VA 2700K/CRI90/ 1580 lm	PL Opal	OS ON-OFF/ 220-240V/50-60Hz	14  60 
		WA 3000K/CRI90/ 1580 lm			
		XA 4000K/CRI90/ 1580 lm			
 <p>AW45 - Lineal / Hängend / 1595mm / 2 Spots 30mm Lineal / Sospesa / 1595mm / 2 Spots 30mm</p>	24 24W	V9 2700K/CRI90/ 2101 lm	BE Bento 52°	DS DALI/220-240V/ 50-60Hz	
		W9 3000K/CRI90/ 2101 lm			
		X9 4000K/CRI90/ 2101 lm			
 <p>AW43 - Lineal / Aufputz / 3180mm / 4 Spots 30mm Lineal / Superficie / 3180mm / 4 Spots 30mm</p>	36 36W	VA 2700K/CRI90/ 2622 lm	PL Opal	OS ON-OFF/ 220-240V/50-60Hz	
		WA 3000K/CRI90/ 2622 lm			
		XA 4000K/CRI90/ 2622 lm			
 <p>AW46 - Lineal / Hängend / 3180mm / 4 Spots 30mm Lineal / Sospesa / 3180mm / 4 Spots 30mm</p>	48 48W	V9 2700K/CRI90/ 4202 lm	BE Bento 52°	DS DALI/220-240V/ 50-60Hz	
		W9 3000K/CRI90/ 4202 lm			
		X9 4000K/CRI90/ 4202 lm			
 <p>AW44 - Lineal / Aufputz / 4190mm / 4 Spots 30mm Lineal / Superficie / 4190mm / 4 Spots 30mm</p>	48 48W	VA 2700K/CRI90/ 4202 lm	PL Opal	OS ON-OFF/ 220-240V/50-60Hz	
		WA 3000K/CRI90/ 4202 lm			
		XA 4000K/CRI90/ 4202 lm			
 <p>AW47 - Lineal / Hängend / 4190mm / 4 Spots 30mm Lineal / Sospesa / 4190mm / 4 Spots 30mm</p>	66 66W	V9 2700K/CRI90/ 5765 lm	BE Bento 52°	DS DALI/220-240V/ 50-60Hz	
		W9 3000K/CRI90/ 5765 lm			
		X9 4000K/CRI90/ 5765 lm			

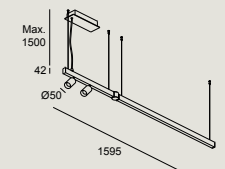
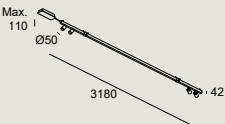

Spot 30mm

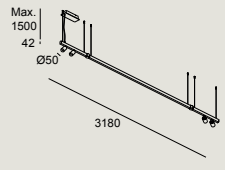
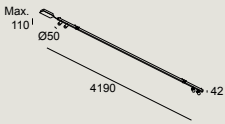
Lineal Double Spot Big

Codebeispiel / Esempio di codice: AW55-36VAPLOS14

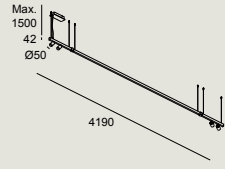
Model	W	K/ CRI/ Real lm	Optics	Source	Finishes		
 <p>AW55 - Lineal / Aufputz / 1595mm / 2 Spots 52mm Lineal / Superficie / 1595mm / 2 Spots 52mm</p>	36 36W	VA 2700K/CRI90/ 2898 lm	PL Opal	OS  ON-OFF/ 220-240V/50-60Hz	14 		
		WA 3000K/CRI90/ 2898 lm				DS  DALI/220-240V/ 50-60Hz	60 
		XA 4000K/CRI90/ 2898 lm				XB  CASAMBI/ 220-240V/ 50-60Hz	
 <p>AW58 - Lineal / Hängend / 1595mm / 2 Spots 52mm Lineal / Sospesa / 1595mm / 2 Spots 52mm</p>	42 42W	V9 2700K/CRI90/ 3419 lm	BE Bento 52°				
		W9 3000K/CRI90/ 3419 lm					
		X9 4000K/CRI90/ 3419 lm					
 <p>AW56 - Lineal / Aufputz / 3180mm / 4 Spots 52mm Lineal / Superficie / 3180mm / 4 Spots 52mm</p>	72 72W	VA 2700K/CRI90/ 3940 lm	PL Opal	OS  ON-OFF/ 220-240V/50-60Hz			
		WA 3000K/CRI90/ 3940 lm				DS  DALI/220-240V/ 50-60Hz	
		XA 4000K/CRI90/ 3940 lm				XB  CASAMBI/ 220-240V/ 50-60Hz	
 <p>AW59 - Lineal / Hängend / 3180mm / 4 Spots 52mm Lineal / Sospesa / 3180mm / 4 Spots 52mm</p>	84 84W	V9 2700K/CRI90/ 6838 lm	BE Bento 52°				
		W9 3000K/CRI90/ 6838 lm					
		X9 4000K/CRI90/ 6838 lm					
 <p>AW57 - Lineal / Aufputz / 4190mm / 4 Spots 52mm Lineal / Superficie / 4190mm / 4 Spots 52mm</p>	84 84W	VA 2700K/CRI90/ 6838 lm	PL Opal	OS  ON-OFF/ 220-240V/50-60Hz			
		WA 3000K/CRI90/ 6838 lm				DS  DALI/220-240V/ 50-60Hz	
		XA 4000K/CRI90/ 6838 lm				XB  CASAMBI/ 220-240V/ 50-60Hz	
 <p>AW61 - Lineal / Hängend / 4190mm / 4 Spots 52mm Lineal / Sospesa / 4190mm / 4 Spots 52mm</p>	CP 102W	V9 2700K/CRI90/ 8401 lm	BE Bento 52°				
		W9 3000K/CRI90/ 8401 lm					
		X9 4000K/CRI90/ 8401 lm					



Spot 52mm



Lineal Triple Spot Small

Codebeispiel / Esempio di codice: AW48-21VAPLOS14

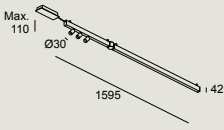
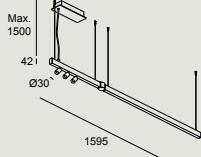
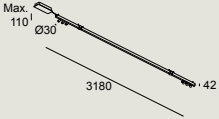
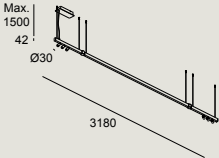
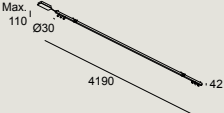
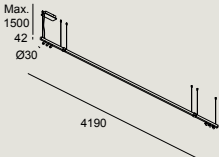
Model	W	K/ CRI/ Real lm	Optics	Source	Finishes
 <p>AW48 - Lineal / Aufputz / 1595mm / 3 Spots 30mm Lineal / Superficie / 1595mm / 3 Spots 30mm</p>	21 21W	VA 2700K/CRI90/ 1849 lm	PL Opal	OS ON-OFF/ 220-240V/50-60Hz	14 60
		WA 3000K/CRI90/ 1849 lm			
		XA 4000K/CRI90/ 1849 lm			
 <p>AW52 - Lineal / Hängend / 1595mm / 3 Spots 30mm Lineal / Sospesa / 1595mm / 3 Spots 30mm</p>	27 27W	V9 2700K/CRI90/ 2370 lm	BE Bento 52°	DS DALI/220-240V/ 50-60Hz	
		W9 3000K/CRI90/ 2370 lm			
		X9 4000K/CRI90/ 2370 lm			
 <p>AW49 - Lineal / Aufputz / 3180mm / 6 Spots 30mm Lineal / Superficie / 3180mm / 6 Spots 30mm</p>	42 42W	VA 2700K/CRI90/ 3160 lm	PL Opal	OS ON-OFF/ 220-240V/50-60Hz	
		WA 3000K/CRI90/ 3160 lm			
		XA 4000K/CRI90/ 3160 lm			
 <p>AW53 - Lineal / Hängend / 3180mm / 6 Spots 30mm Lineal / Sospesa / 3180mm / 6 Spots 30mm</p>	54 54W	V9 2700K/CRI90/ 4740 lm	BE Bento 52°	DS DALI/220-240V/ 50-60Hz	
		W9 3000K/CRI90/ 4740 lm			
		X9 4000K/CRI90/ 4740 lm			
 <p>AW51 - Lineal / Aufputz / 4190mm / 6 Spots 30mm Lineal / Superficie / 4190mm / 6 Spots 30mm</p>	54 54W	VA 2700K/CRI90/ 4740 lm	PL Opal	OS ON-OFF/ 220-240V/50-60Hz	
		WA 3000K/CRI90/ 4740 lm			
		XA 4000K/CRI90/ 4740 lm			
 <p>AW54 - Lineal / Hängend / 4190mm / 6 Spots 30mm Lineal / Sospesa / 4190mm / 6 Spots 30mm</p>	72 72W	V9 2700K/CRI90/ 6303 lm	BE Bento 52°	DS DALI/220-240V/ 50-60Hz	
		W9 3000K/CRI90/ 6303 lm			
		X9 4000K/CRI90/ 6303 lm			

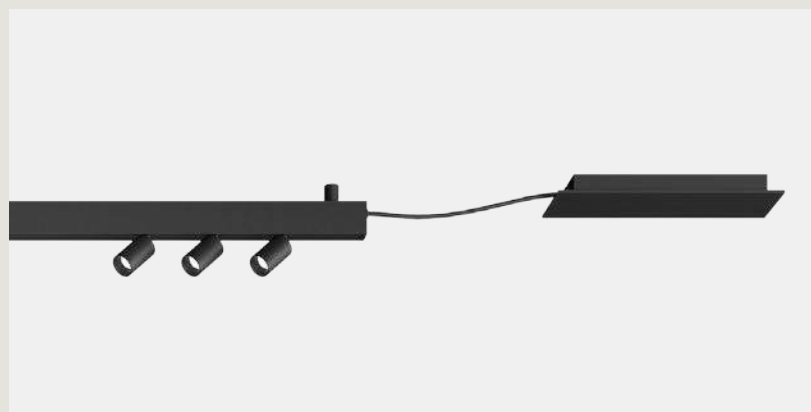

Installation oberfläche
Installazione in superficie

APEX Square



3
MacAdam

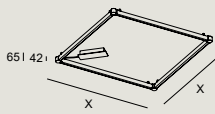
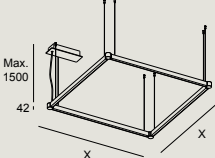
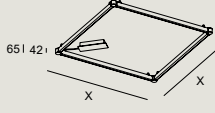
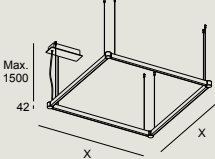
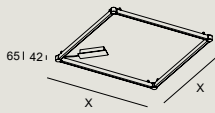
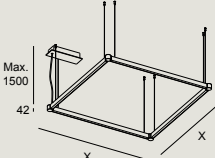

Codebeispiel / Esempio di codice: AW22-48VAPLOS14

Model	W	K/ CRI/ Real lm	Optics	Source	Finishes		
 <p>AW22 - Square / Aufputz / 1000mm Square / Superficie / 1000mm</p>	48 48W	VA 2700K/CRI90/ 4168 lm	PL Opal	OS ON-OFF/ 220-240V/50-60Hz	14		
		WA 3000K/CRI90/ 4168 lm				DS DALI/220-240V/ 50-60Hz	60
		XA 4000K/CRI90/ 4168 lm				XB CASAMBI/ 220-240V/ 50-60Hz	
 <p>AW25 - Square / Hängend / 1000mm Square / Sospesa / 1000mm</p>	72 72W	V9 2700K/CRI90/ 6252 lm	BE Bento 52°				
		W9 3000K/CRI90/ 6252 lm					
		X9 4000K/CRI90/ 6252 lm					
 <p>AW23 - Square / Aufputz / 2000mm Square / Superficie / 2000mm</p>	96 96W	VA 2700K/CRI90/ 8336 lm	PL Opal	OS ON-OFF/ 220-240V/50-60Hz			
		WA 3000K/CRI90/ 8336 lm				DS DALI/220-240V/ 50-60Hz	
		XA 4000K/CRI90/ 8336 lm				XB CASAMBI/ 220-240V/ 50-60Hz	
 <p>AW26 - Square / Hängend / 2000mm Square / Sospesa / 2000mm</p>	C4 144W	V9 2700K/CRI90/ 12504 lm	BE Bento 52°				
		W9 3000K/CRI90/ 12504 lm					
		X9 4000K/CRI90/ 12504 lm					
 <p>AW24 - Square / Aufputz / 3000mm Square / Superficie / 3000mm</p>	C4 144W	VA 2700K/CRI90/ 12504 lm	PL Opal	OS ON-OFF/ 220-240V/50-60Hz			
		WA 3000K/CRI90/ 12504 lm				DS DALI/220-240V/ 50-60Hz	
		XA 4000K/CRI90/ 12504 lm				XB CASAMBI/ 220-240V/ 50-60Hz	
 <p>AW27 - Square / Hängend / 3000mm Square / Sospesa / 3000mm</p>	D1 216W	V9 2700K/CRI90/ 18756 lm	BE Bento 52°				
		W9 3000K/CRI90/ 12504 lm					
		X9 4000K/CRI90/ 12504 lm					

INDOOR LINEARE BELEUCHTUNGSSYSTEME / SISTEMI LINEARI D'ILLUMINAZIONE



Installation oberfläche
Installazione in superficie

APEX

Rectangular

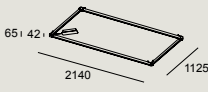
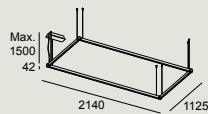
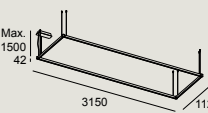
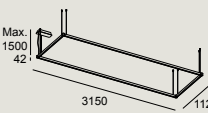

Codebeispiel / Esempio di codice: AW28-72VAPLOS14

Model	W	K/ CRI/ Real lm	Optics	Source	Finishes
 <p>AW28 - Rectangular / Aufputz / 1125mm x 2140mm Rectangular / Superficie / 1125mm x 2140mm</p>	72 72W	VA 2700K/CRI90/ 6252 lm	PL Opal	OS ON-OFF/ 220-240V/50-60Hz DS DALI/220-240V/ 50-60Hz XB CASAMBI/ 220-240V/ 50-60Hz 	14 60
		WA 3000K/CRI90/ 6252 lm			
		XA 4000K/CRI90/ 6252 lm			
 <p>AW29 - Rectangular / Hängend / 1125mm x 2140mm Rectangular / Sospesa / 1125mm x 2140mm</p>	CP 108W	V9 2700K/CRI90/ 9378 lm	BE Bento 52°		
		W9 3000K/CRI90/ 9378 lm			
		X9 4000K/CRI90/ 9378 lm			
 <p>AW31 - Rectangular / Hängend / 1125mm x 3150mm Rectangular / Sospesa / 1125mm x 3150mm</p>	96 96W	VA 2700K/CRI90/ 8336 lm	PL Opal	OS ON-OFF/ 220-240V/50-60Hz DS DALI/220-240V/ 50-60Hz XB CASAMBI/ 220-240V/ 50-60Hz 	
		WA 3000K/CRI90/ 8336 lm			
		XA 4000K/CRI90/ 8336 lm			
 <p>AW32 - Rectangular / Hängend / 1125mm x 3150mm Rectangular / Sospesa / 1125mm x 3150mm</p>	C4 144W	V9 2700K/CRI90/ 12504 lm	BE Bento 52°		
		W9 3000K/CRI90/ 9378 lm			
		X9 4000K/CRI90/ 9378 lm			



Bento optics

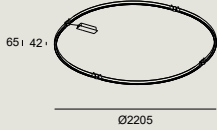
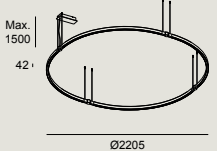
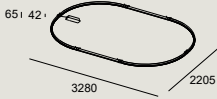
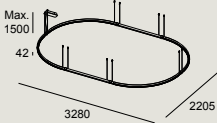

Model	W	K/ CRI/ Real lm	Optics	Source	Finishes	
 <p>AW17 - Circular / Aufputz Circular / Superficie</p> <p>65 42 Ø2205</p>	76 76W	VA 2700K/CRI90/ 6544 lm	PL Opal	OS ON-OFF/ 220-240V/50-60Hz	14 60	
		WA 3000K/CRI90/ 6544 lm		DS DALI/220-240V/ 50-60Hz		
		XA 4000K/CRI90/ 6544 lm		XB CASAMBI/ 220-240V/ 50-60Hz		
 <p>AW18 - Circular / Hängend Circular / Sospesa</p> <p>Max. 1500 42 Ø2205</p>						
		 <p>AW19 - Oval / Aufputz Oval / Superficie</p> <p>65 42 3280 2205</p>	100 100W	VA 2700K/CRI90/ 8628 lm	PL Opal	OS ON-OFF/ 220-240V/50-60Hz
				WA 3000K/CRI90/ 8628 lm		DS DALI/220-240V/ 50-60Hz
XA 4000K/CRI90/ 8628 lm	XB CASAMBI/ 220-240V/ 50-60Hz					
 <p>AW21 - Oval / Hängend Oval / Sospesa</p> <p>Max. 1500 42 3280 2205</p>						

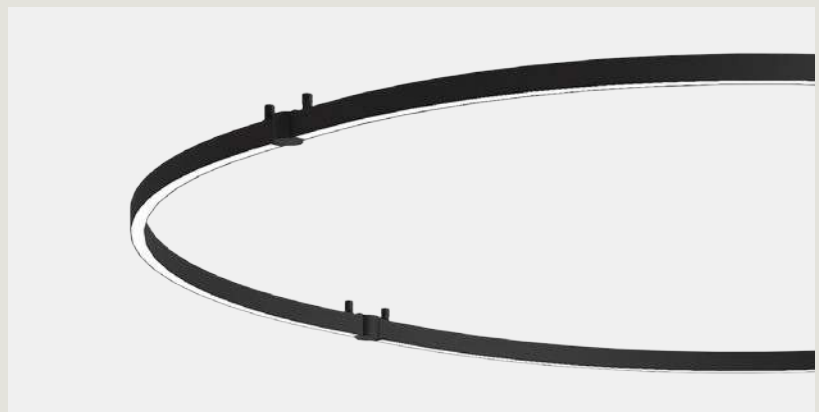







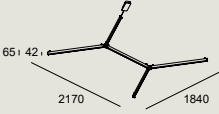

Aufputz
Superficie

APEX

Apex H

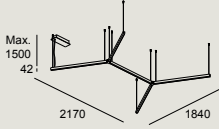

Codebeispiel / Esempio di codice: AW35-60VAPLOS14

Model	W	K/ CRI/ Real lm	Optics	Source	Finishes
 <p>AW35 - "H" / Aufputz "H" / Superficie</p>	60 60W	VA 2700K/CRI90/ 5210 lm	PL Opal	OS  ON-OFF/ 220-240V/50-60Hz	14  60 
		WA 3000K/CRI90/ 5210 lm		DS  DALI/220-240V/ 50-60Hz	
		XA 4000K/CRI90/ 5210 lm		XB  CASAMBI/ 220-240V/ 50-60Hz	
 <p>AW36 - "H" / Hängend "H" / Sospesa</p>	90 90W	V9 2700K/CRI90/ 7815 lm	BE Bento 52°		
		W9 3000K/CRI90/ 7815 lm			
		X9 4000K/CRI90/ 7815 lm			

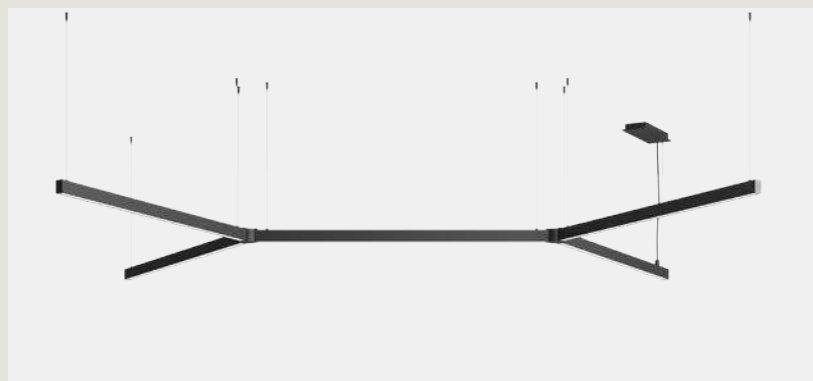

Installation hängend
installazione in sospensione

APEX







Apex M

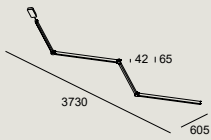

3
MacAdam

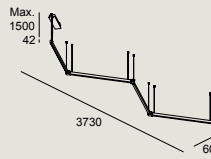

Codebeispiel / Esempio di codice: AW39-48VAPLOS14

Model	W	K/ CRI/ Real lm	Optics	Source	Finishes
 <p>AW39 - "M" / Aufputz "M" / Superficie</p>	48 48W	VA 2700K/CRI90/ 4168 lm	PL Opal	OS  ON-OFF/ 220-240V/50-60Hz	14  60 
		WA 3000K/CRI90/ 4168 lm		DS  DALI/220-240V/ 50-60Hz	
		XA 4000K/CRI90/ 4168 lm		XB  CASAMBI/ 220-240V/ 50-60Hz	
 <p>AW41 - "M" / Hängend "M" / Sospesa</p>	72 72W	V9 2700K/CRI90/ 6252 lm	BE Bento 52°		
		W9 3000K/CRI90/ 6252 lm			
		X9 4000K/CRI90/ 6252 lm			

INDOOR LINEARE BELEUCHTUNGSSYSTEME / SISTEMI LINEARI D'ILLUMINAZIONE









Installation oberfläche
Installazione in superficie

APEX

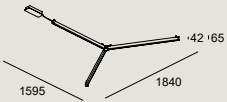
Apex Y

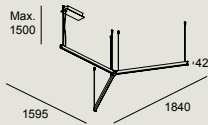

Codebeispiel / Esempio di codice: AW33-36VAPLOS14

Model	W	K/ CRI/ Real lm	Optics	Source	Finishes
 <p>AW33 - "Y" / Aufputz "Y" / Superficie</p>	36 36W	VA 2700K/CRI90/ 3126 lm	PL Opal	OS  ON-OFF/ 220-240V/ 50-60Hz	14  60 
		WA 3000K/CRI90/ 3126 lm			
		XA 4000K/CRI90/ 3126 lm			
		V9 2700K/CRI90/ 4689 lm			
 <p>AW34 - "Y" / Hängend "Y" / Sospesa</p>	54 54W	W9 3000K/CRI90/ 4689 lm	BE Bento 52°	DS  DALI/220-240V/ 50-60Hz	
		X9 4000K/CRI90/ 4689 lm			
		XB  CASAMBI/ 220-240V/ 50-60Hz			



Installation hängend
installazione in sospensione

APEX









Apex WW

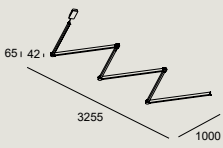

3
MacAdam

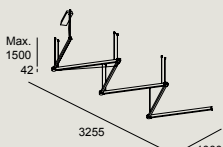

Codebeispiel / Esempio di codice: AW37-72VAPLOS14

Model	W	K/ CRI/ Real lm	Optics	Source	Finishes	
 <p>AW37 - "WW" / Aufputz "WW" / Superficie</p>	72 72W	VA 2700K/CRI90/ 6252 lm	PL Opal	OS  ON-OFF/ 220-240V/ 50-60Hz	14  60 	
		WA 3000K/CRI90/ 6252 lm				DS  DALI/220-240V/ 50-60Hz
		XA 4000K/CRI90/ 6252 lm				XB  CASAMBI/ 220-240V/ 50-60Hz
 <p>AW38 - "WW" / Hängend "WW" / Sospesa</p>	CP 108W	V9 2700K/CRI90/ 9378 lm	BE Bento 52°			
		W9 3000K/CRI90/ 9378 lm				
		X9 4000K/CRI90/ 9378 lm				

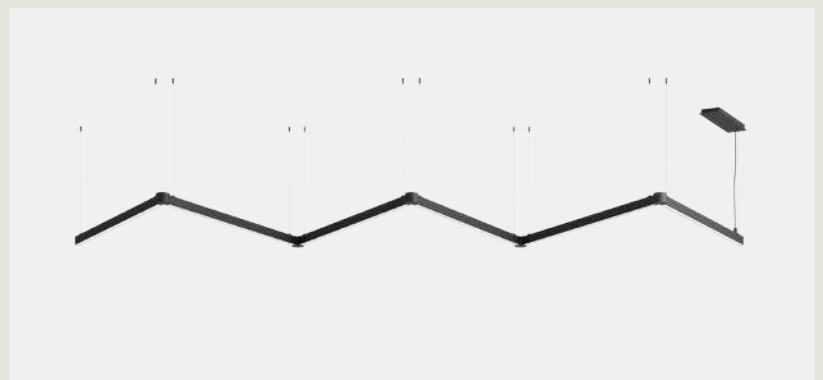

Installation hängend
installazione in sospensione

Lineal

BODY MAT	DIF MAT
AL	PC



54 ○

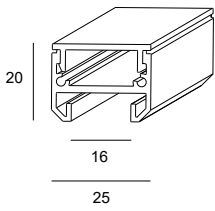

mm	Code
2000	71-3454 - 54 - M2 M3



54 ○

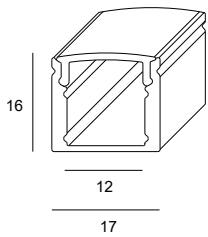

mm	Code
2000	71-A296 - 54 - M3

Lineal

BODY MAT	DIF MAT
AL	PC

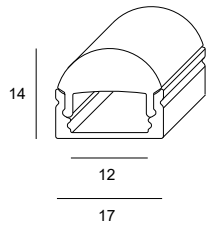

54 

mm	Code
2000	71-8125 - 54 - M3

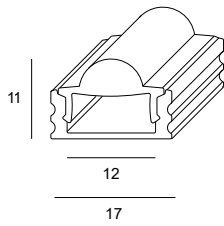

54 

mm	Code
2000	71-8126 - 54 - M3

Lineal

BODY MAT	DIF MAT
AL	PC

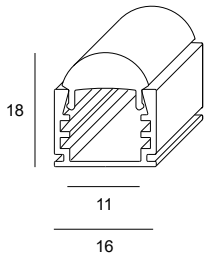

54 

mm	Code
2000	71-8127 - 54 - M3

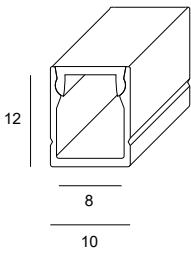
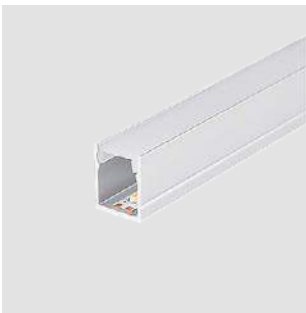

54 

mm	Code
2000	71-8128 - 54 - M3

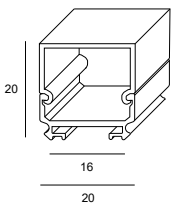

54 

mm	Code
2000	71-8129 - 54 - M3

Lineal

BODY MAT	DIF MAT
AL	PC

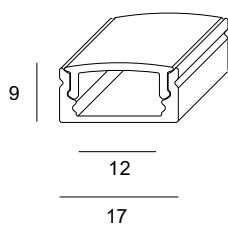

54 

mm	Code
2000	71-8130 - 54 - M3

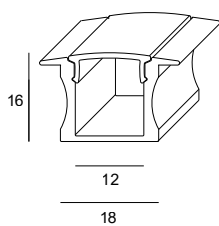

54 

mm	Code
2000	71-8131 - 54 - M3

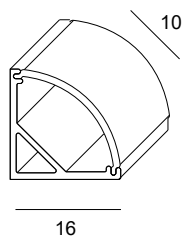

54 

mm	Code
2000	71-8132 - 54 - M3



Taglio di Luce

Direct P. 397

Indirect P. 399

Surface

Recessed trimless

Recessed trim

Surface

Recessed



19 mm

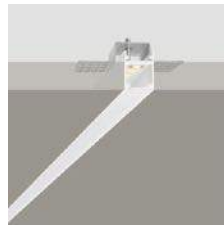

19 mm



19 mm



28 mm



81 mm



35 mm



35 mm



35 mm



50 mm



50 mm



50 mm

14 ○



14 ○



14 ○



14 ○



14 ○



Taglio di Luce

BODY MAT

AL



Die Kollektion Taglio di Luce ermöglicht eine integrierte Beleuchtung, bei der das Licht mit dem Raum verschmilzt. Es bietet Architekten und Designern die Möglichkeit, lineare Kompositionen mit Effekten an Wänden und Decken zu erschaffen. Die Struktur ist aus Aluminium gefertigt und mit weißer Pulverfarbe lackiert.

La collezione Taglio di Luce ci apre le porte verso un'illuminazione integrata, dove la luce si fonde nello spazio, offrendo la possibilità ad architetti e progettisti di creare composizioni lineari, con effetti su pareti e soffitti. La struttura è realizzata in alluminio e verniciata a polvere in colore bianco.

Lichteffekte Effetti di luce

Das System der Kollektion Taglio di Luce bietet eine grenzenlose direkte und indirekte lineare Beleuchtung.

Il sistema Taglio di Luce è una collezione che offre un'illuminazione lineare diretta e indiretta senza limiti.





TAGLIO DI LUCE DIREKT

Direkte lineare Beleuchtung

Ob als Aufputz oder Unterputz, das System bietet eine direkte Beleuchtung, die sich durch Lichteffekte und Lichtspiele in die Architektur einfügt, Räume hervorhebt und Wege markiert. Es bedient alle Arten von Bedürfnissen - funktionale wie dekorative.

Illuminazione lineare diretta

Con installazione a superficie o incassata, con cornice o senza, offre un'illuminazione diretta che, tramite effetti e giochi di luce, si integra nell'architettura, mettendo in risalto gli spazi e disegnando percorsi adatti a qualsiasi tipo di esigenza, funzionale o decorativa.

Maßgeschneidert Taglio su misura

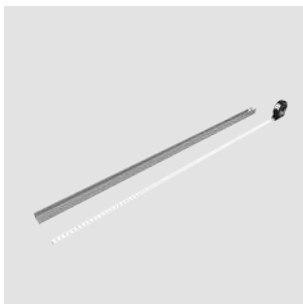

TAGLIO DI LUCE INDIREKT

Indirekte lineare Beleuchtung

Ob als Aufputz oder Unterputz, das System erschafft eine indirekte und dekorative Beleuchtung, die sich vollständig in den Raum integriert. Ideal für die Nischenbeleuchtung.

Illuminazione lineare indiretta

Con installazione a superficie o incassata, offre un'illuminazione indiretta e decorativa, completamente integrata nello spazio, ideale per perimetri con effetto di fossato.

Taglio di Luce passt sich ganz dem jeweiligen Projekt an. Die Kollektion erlaubt es, Profile und Diffusoren auf das richtige Maß zuzuschneiden. So sind durchgängige Diffusoren mit Längen von bis zu 10 Metern möglich. Die maßgeschneiderten Profile enthalten alle Elemente, die sowohl für die Installation, als auch für die Verarbeitung benötigt werden (Diffusor und Abdeckung). Darüber hinaus kennzeichnen wir jedes maßgeschneiderte Profil mit einem Etikett, welches das vom Kunden gewünschte Konzept oder den gewünschten Bereich angibt. Maßgeschneiderte Lichtquellen (LED-Streifen), die nicht in dem Profilmfang inbegriffen sind, sind ebenfalls erhältlich. So können Sie die Variante wählen, die am besten zu Ihrem ganz individuellen Projekt passt.

Taglio di Luce si adatta totalmente ai progetti, con la possibilità di tagliare il profilo e i diffusori su misura, ed è in grado di offrire un diffusore continuo lungo fino a 10 metri. I profili tagliati su misura includono tutti gli elementi necessari sia per la loro installazione che per la loro finitura (diffusore e tappi). Inoltre, ogni profilo tagliato viene identificato con un'etichetta identificativa del progetto o della zona richiesta dal cliente. È, inoltre, incluso anche il taglio su misura delle sorgenti luminose (strisce di led) non incluse nel profilo. In questo modo è possibile scegliere la soluzione più adatta a ciascun progetto.

Optionen von Lichtquellen Opzioni sorgente luminosa

Durch die Kombination mit den LED-Streifen-Kollektionen On Basic, On Performance und On Advance eröffnet Taglio di Luce eine große Vielfalt an Möglichkeiten. Die Kollektion On bietet eine breite Palette an Lösungen, um die perfekte Beleuchtung für jede Spezifika von Raum zu ermöglichen. Mit einer Leistung von 4,9 W/m bis 28,8 W/m, einer großen Auswahl an verschiedenen Größen, von 4 mm breiten Lösungen bis hin zu doppelt parallelen LED-Streifen, hoher Farbwiedergabe CRI98, Version IP20 und IP65 und verschiedenen Farbtemperaturen von 2700K bis 6500K, RGB und RGBW. Sehen Sie sich die gesamte Kollektion On in der Kategorie LED-Streifen an.

Taglio di Luce apre a un'ampia varietà di possibilità, dal momento che può essere combinata con la collezione di strisce al LED ON Basic, On Performance e On Advance. La collezione On presenta un'infinità di soluzioni per ottenere l'illuminazione perfetta e specifica per ciascuno spazio. Con potenze che vanno da 4,9w/m a 28,8w/m, un gran numero di misure, da soluzioni con una larghezza di soli 4 mm fino a strisce a doppio LED parallelo, un'elevata riproduzione cromatica CRI98, versioni con IP20 e IP65 e varie temperature di colore, da 2700K fino a 6500K, RGB e RGBW. Vedere tutta la collezione On nella categoria strisce al LED.



Verbindungselemente Elementi di unione

Die Verbindungselemente wurden speziell dazu entwickelt, perfekte Verbindungen zu erschaffen, die eine durchgängige und nahtlose Wirkung erzeugen. Diese Elemente ermöglichen es, geradlinige geometrische Lichtlinien zu zeichnen und werden so dem Anspruch eines jeden Projekts gerecht. Taglio di Luce bietet sowohl einfache Verbindungssysteme, wie das Profilverbindungsset "I", um zwei Profile zu verbinden, die in dieselbe Richtung verlaufen, als auch komplexere Verbindungssysteme, wie das Verbindungsset "X", um 4 Profile kreuzartig aneinander anzuschließen, oder das vertikale Verbindungsset "LVE", um von einer Deckeninstallation zu einer Wandinstallation zu gelangen.

I giunti sono elementi sviluppati ex professo, che garantiscono unioni perfette, assicurando un effetto continuo e senza interruzioni. Questi elementi, consentono di tracciare linee di luce geometriche rettilinee e affrontare la complessità di qualsiasi progetto. Taglio di Luce offre dai giunti più semplici, come il kit unione profilo "I", per collegare due profili orientati nella stessa direzione, fino a giunti più complessi come il kit unione "X", per collegare 4 profili a croce o il Kit unione verticale "LVE" per passare da un'installazione a soffitto a una a parete.

TAGLIO DI LUCE DIRECT



Die Kollektion Taglio di Luce Direkt ermöglicht lineare, endlose Kompositionen und erzeugt Effekte an Wänden und Decken, welche die Architektur der Räumlichkeiten in Szene setzen. La collezione Taglio di Luce Direct offre composizioni lineari infinite, con effetti su pareti e soffitti, enfatizzando l'architettura degli spazi.



Varianten Versioni

Taglio di Luce Direkt ist in den Größen 19 mm, 35 mm und 50 mm erhältlich. Alle Größen sind in zuschneidbarer oder nicht zuschneidbarer Variante verfügbar. Taglio di Luce è disponibile da 19 mm, 35 mm e 50 mm. Sempre nelle versioni trim e trimless.



Montagemöglichkeiten Installazioni possibili



Aufputz

Die Aufputzvariante eignet sich ideal für die einfache Anbringung an Betondecken, Holzverkleidungen und anderen Materialien, die das Einbauen in die Oberfläche erschweren.

Superficie

La versione da superficie è facilissima da installare su soffitti in cemento, strutture di legno o altri materiali dove l'incasso è difficoltoso.

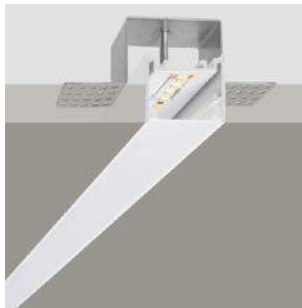

Unterputz ohne Rahmen

Die rahmenlose Unterputzvariante fügt sich elegant und absolut sauber in die Oberfläche ein, sodass einzig und allein das Licht im Fokus steht.

Da incasso senza cornice

La versione da incasso senza cornice ottiene una finitura eccellente nello spazio, completamente pulita e integrata, dove l'unica cosa che risalta è la luce.



Unterputz mit Rahmen

Die Unterputzvariante mit Rahmen zeichnet sich durch seine einfache Anbringung aus. Dank des sauberen Designs und der Integration der Klappen werden kleine Unebenheiten, die bei der Montagebohrung entstehen, sanft ausgeglichen.

Da incasso con cornice

La versione da incasso con cornice è facilissima da installare grazie al disegno pulito e integrato delle alette, che consentono di coprire le piccole irregolarità del foro di installazione.

TAGLIO DI LUCE INDIRECT



Die Kollektion Taglio di Luce Indirekt schafft Kompositionen aus unauffälligem Licht, ideal für die indirekte und weiche Beleuchtung von Räumen, wie Lobbys, Restaurants, Konferenzräumen, Schlafzimmern oder Bädern.

La collezione Taglio di Luce Indirect offre composizioni di percorsi perimetrali perfette per creare un'illuminazione indiretta e soffusa in spazi di ogni tipo come lobby, ristoranti, sale riunioni, camere o bagni.



Montagemöglichkeiten Installazioni possibili

Aufputz

Die Aufputzvariante ist einfach zu installieren und fügt sich optimal in den Raum ein, da ihr Profil lackiert werden kann und sie so farblich an die Umgebung angepasst wird.

Superficie

La versione da superficie è facile da installare e si integra perfettamente nello spazio, grazie al profilo che può essere dipinto con il colore finale dell'installazione.

Unterputz

Die Unterputzvariante integriert sich vollständig in den Raum. Die Leuchte ist unauffällig in der Decke verborgen und eignet sich so ideal als Nischenbeleuchtung.

Da incasso

La versione da incasso si integra completamente nello spazio dove la luce resta completamente nascosta nel soffitto, è perfetta per perimetri con effetto fossato.

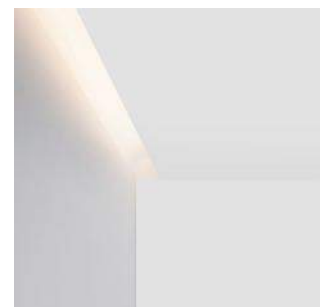
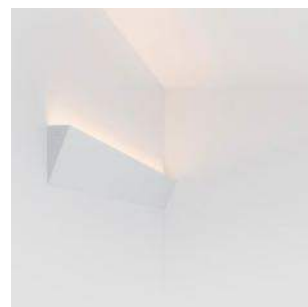

A01

.02



TAGLIO DI LUCE

Taglio di Luce Direct

Installationsschema
Schema di installazione

Ohne rahmen / Senza cornice
19 / 35 / 50mm

Mit rahmen / Con cornice
28 / 49 / 66mm

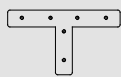
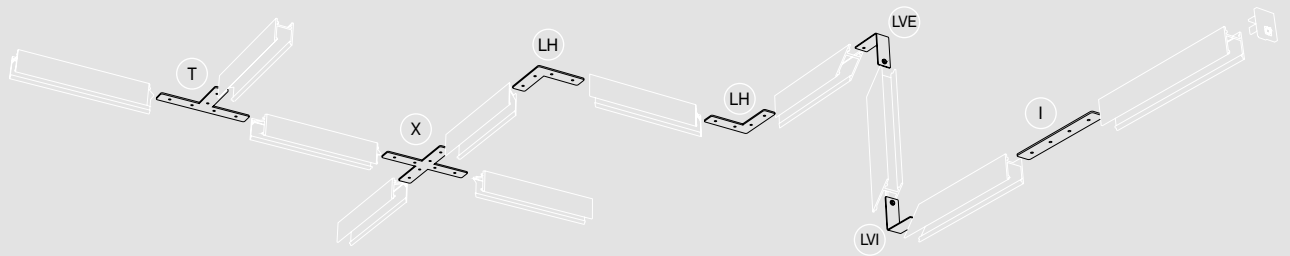

Verbinder T
Kit unione T

71-5784-00-00

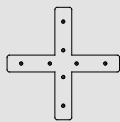

Verbinder X
Kit unione X

71-5785-00-00



Verbinder LH
Kit unione LH

71-5783-00-00



Verbinder LVE
Kit unione LVE

71-5757-00-00



Verbinder I
Kit di unione I

71-5782-00-00



Verbinder LVI
Kit unione LVI

71-5758-00-00

TAGLIO DI LUCE

Taglio di Luce Direct 19mm Trimless

14 

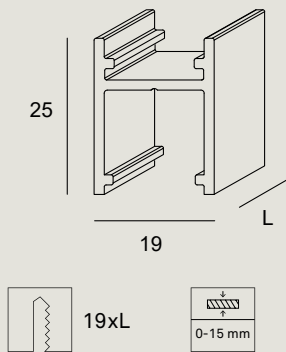

Standardgrößen / Misure standard		
mm	Code	
1000	71-5741	
2000	71-5742 - 14 - 00	
3000	71-5743	

Zubehör nicht inklusive und erforderlich / Accessori non inclusi e necessari	
Kappe 19 mm ohne Rahmen Tappo 19mm senza cornice	71-5766-14-00
Diffusor 1000 mm Diffusore 1000mm	71-5771-00-00
Diffusor 2000 mm Diffusore 2000mm	71-5772-00-00
Diffusor 3000mm Diffusore 3000mm	71-5773-00-00
Diffusor 10000 mm Diffusore 10000mm	71-5774-00-00
Unterputzset 1000 mm ohne Rahmen Kit da incasso 1000mm senza cornice	71-5786-00-00

Zubehör nicht inklusive / Accessori non inclusi	
LVE-Verbindungsset Kit unione LVE	71-5757-00-00
LVI-Verbindungsset Kit unione LVI	71-5758-00-00
I-Verbindungsset Kit unione I	71-5782-00-00
LH-Verbindungsset Kit unione LH	71-5783-00-00
T-Verbindungsset Kit unione T	71-5784-00-00
X-Verbindungsset Kit unione X	71-5785-00-00



Kundenspezifische Länge / Taglio su misura	
mm	Code
Custom size	71-5743 - 14 - 00L

*Alle kundenspezifisch zugeschnittenen Profile beinhalten Einbausatz, Deckel, Diffusoren und die erforderlichen Verbindungen. Die maximale Länge des Profils beträgt 3 Meter. Für größere Längen werden Verbindungssätze mitgeliefert, mit denen die gewünschte Größe hergestellt werden kann. Soweit möglich und bis zu einer Länge von 10 m wird der Diffusor in einem einzigen Stück ohne Schnitte geliefert. Kundenspezifische Längen: siehe S. 412

*Tutti i profili tagliati a misura includono un kit di installazione, coperchi, diffusori e le giunte necessarie. La misura massima del profilo è di 3 metri. Per le taglie più grandi saranno inclusi i kit di unione a "I" per poter costruire la misura desiderata. Per quanto possibile, e fino a 10m di lunghezza, il diffusore sarà servito in un'unica sezione, senza tagli. Per effettuare l'ordine di taglio a misura, consultare pag. 412

Empfohlene LED-Streifen / Strisce LED raccomandate	
Code	Description
91-7929-00-00	9,6W/m-3000K
91-5572-00-00	19,2W/m-3000K

*Weitere Informationen: siehe Kollektion ON auf S. 425

*Per ulteriori opzioni, consultare la collezione ON a pag. 425

TAGLIO DI LUCE

Taglio di Luce Direct 28mm Trim

14 

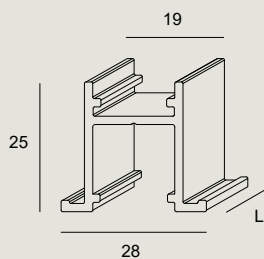

20xL



0-20 mm

Standardgrößen / Misure standard		
mm	Code	
1000	71-5738	
2000	71-5739 - 14 - 00	
3000	71-5740	

Zubehör nicht inklusive und erforderlich / Accessori non inclusi e necessari		
Unterputzset 1000 mm Kit da incasso 1000mm	71-5511-00-00	
Kappe 19 mm mit Rahmen Tappo 19mm con cornice	71-5765-14-00	
Diffusor 1000 mm Diffusore 1000mm	71-5771-00-00	
Diffusor 2000 mm Diffusore 2000mm	71-5772-00-00	
Diffusor 3000mm Diffusore 3000mm	71-5773-00-00	
Diffusor 10000 mm Diffusore 10000mm	71-5774-00-00	

Zubehör nicht inklusive / Accessori non inclusi		
LVE-Verbindungsset Kit unione LVE	71-5757-00-00	
LVI-Verbindungsset Kit unione LVI	71-5758-00-00	
I-Verbindungsset Kit unione I	71-5782-00-00	
LH-Verbindungsset Kit unione LH	71-5783-00-00	
T-Verbindungsset Kit unione T	71-5784-00-00	
X-Verbindungsset Kit unione X	71-5785-00-00	



Kundenspezifische Länge / Taglio su misura		
mm	Code	
Custom size	71-5740 - 14 - 00L	

*Alle kundenspezifisch zugeschnittenen Profile beinhalten Einbausatz, Deckel, Diffusoren und die erforderlichen Verbindungen. Die maximale Länge des Profils beträgt 3 Meter. Für größere Längen werden Verbindungssätze mitgeliefert, mit denen die gewünschte Größe hergestellt werden kann. Soweit möglich und bis zu einer Länge von 10 m wird der Diffusor in einem einzigen Stück ohne Schnitte geliefert. Kundenspezifische Längen: siehe S. 412

*Tutti i profili tagliati a misura includono un kit di installazione, coperchi, diffusori e le giunte necessarie. La misura massima del profilo è di 3 metri. Per le taglie più grandi saranno inclusi i kit di unione a "I" per poter costruire la misura desiderata. Per quanto possibile, e fino a 10m di lunghezza, il diffusore sarà servito in un'unica sezione, senza tagli. Per effettuare l'ordine di taglio a misura, consultare pag. 412

Empfohlene LED-Streifen / Strisce LED raccomandate		
Code	Description	
91-7929-00-00	9,6W/m-3000K	
91-5572-00-00	19,2W/m-3000K	

*Weitere Informationen: siehe Kollektion ON auf S. 425

*Per ulteriori opzioni, consultare la collezione ON a pag. 425

TAGLIO DI LUCE

Taglio di Luce Direct 35mm Trimless

14 

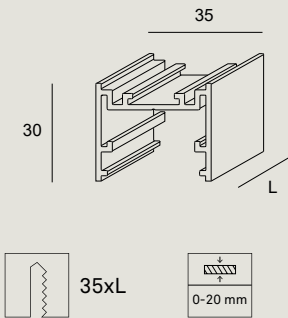

Standardgrößen / Misure standard	
mm	Code
1000	71-5747
2000	71-5748 - 14 - 00
3000	71-5749

Zubehör nicht inklusive und erforderlich / Accessori non inclusi e necessari	
Kappe 35 mm ohne Rahmen Tappo 35mm senza cornice	71-5768-14-00
Diffusor 1000 mm Diffusore 1000mm	71-5775-00-00
Diffusor 2000 mm Diffusore 2000mm	71-5776-00-00
Diffusor 3000mm Diffusore 3000mm	71-5777-00-00
Diffusor 10000 mm Diffusore 10000mm	71-5778-00-00
Unterputzset 1000 mm ohne Rahmen Kit da incasso 1000mm senza cornice	71-5787-00-00

Zubehör nicht inklusive / Accessori non inclusi	
LVE-Verbindungsset Kit unione LVE	71-5757-00-00
LVI-Verbindungsset Kit unione LVI	71-5758-00-00
I-Verbindungsset Kit unione I	71-5782-00-00
LH-Verbindungsset Kit unione LH	71-5783-00-00
T-Verbindungsset Kit unione T	71-5784-00-00
X-Verbindungsset Kit unione X	71-5785-00-00



Kundenspezifische Länge / Taglio su misura	
mm	Code
Custom size	71-5749 - 14 - 00L

*Alle kundenspezifisch zugeschnittenen Profile beinhalten Einbausatz, Deckel, Diffusoren und die erforderlichen Verbindungen. Die maximale Länge des Profils beträgt 3 Meter. Für größere Längen werden Verbindungssätze mitgeliefert, mit denen die gewünschte Größe hergestellt werden kann. Soweit möglich und bis zu einer Länge von 10 m wird der Diffusor in einem einzigen Stück ohne Schnitte geliefert. Kundenspezifische Längen: siehe S. 412

*Tutti i profili tagliati a misura includono un kit di installazione, coperchi, diffusori e le giunte necessarie. La misura massima del profilo è di 3 metri. Per le taglie più grandi saranno inclusi i kit di unione a "I" per poter costruire la misura desiderata. Per quanto possibile, e fino a 10m di lunghezza, il diffusore sarà servito in un'unica sezione, senza tagli. Per effettuare l'ordine di taglio a misura, consultare pag. 412

Empfohlene LED-Streifen / Strisce LED raccomandate	
Code	Description
91-7927-00-00	14,4W/m-3000K
91-5572-00-00	28,8W/m-3000K

*Weitere Informationen: siehe Kollektion ON auf S. 425

*Per ulteriori opzioni, consultare la collezione ON a pag. 425

TAGLIO DI LUCE

Taglio di Luce Direct 49mm Trim

14 

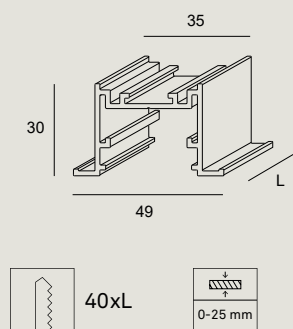

Standardgrößen / Misure standard		
mm	Code	
1000	71-5744	
2000	71-5745 - 14 - 00	
3000	71-5746	

Zubehör nicht inklusive und erforderlich / Accessori non inclusi e necessari		
Unterputzset 1000 mm Kit da incasso 1000mm	71-5511-00-00	
Kappe 35 mm mit Rahmen Tappo 35mm con cornice	71-5767-14-00	
Diffusor 1000 mm Diffusore 1000mm	71-5775-00-00	
Diffusor 2000 mm Diffusore 2000mm	71-5776-00-00	
Diffusor 3000mm Diffusore 3000mm	71-5777-00-00	
Diffusor 10000 mm Diffusore 10000mm	71-5778-00-00	

Zubehör nicht inklusive / Accessori non inclusi		
LVE-Verbindungsset Kit unione LVE	71-5757-00-00	
LVI-Verbindungsset Kit unione LVI	71-5758-00-00	
I-Verbindungsset Kit unione I	71-5782-00-00	
LH-Verbindungsset Kit unione LH	71-5783-00-00	
T-Verbindungsset Kit unione T	71-5784-00-00	
X-Verbindungsset Kit unione X	71-5785-00-00	



Kundenspezifische Länge / Taglio su misura		
mm	Code	
Custom size	71-5746 - 14 - 00L	

*Alle kundenspezifisch zugeschnittenen Profile beinhalten Einbausatz, Deckel, Diffusoren und die erforderlichen Verbindungen. Die maximale Länge des Profils beträgt 3 Meter. Für größere Längen werden Verbindungssätze mitgeliefert, mit denen die gewünschte Größe hergestellt werden kann. Soweit möglich und bis zu einer Länge von 10 m wird der Diffusor in einem einzigen Stück ohne Schnitte geliefert. Kundenspezifische Längen: siehe S. 412

*Tutti i profili tagliati a misura includono un kit di installazione, coperchi, diffusori e le giunte necessarie. La misura massima del profilo è di 3 metri. Per le taglie più grandi saranno inclusi i kit di unione a "I" per poter costruire la misura desiderata. Per quanto possibile, e fino a 10m di lunghezza, il diffusore sarà servito in un'unica sezione, senza tagli. Per effettuare l'ordine di taglio a misura, consultare pag. 412

Empfohlene LED-Streifen / Strisce LED raccomandate		
Code	Description	
91-7927-00-00	14,4W/m-3000K	
91-5572-00-00	28,8W/m-3000K	

*Weitere Informationen: siehe Kollektion ON auf S. 425

*Per ulteriori opzioni, consultare la collezione ON a pag. 425

TAGLIO DI LUCE

Taglio di Luce Direct 50mm Trimless

14 

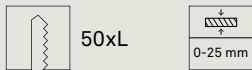
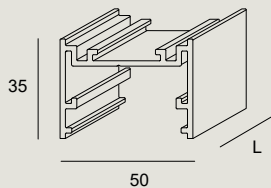

Standardgrößen / Misure standard		
mm	Code	
1000	71-5753	
2000	71-5754 - 14 - 00	
3000	71-5755	

Zubehör nicht inklusive und erforderlich / Accessori non inclusi e necessari	
Diffusor 10000 mm Diffusore 10000mm	71-5486-00-00
Kappe 50 mm ohne Rahmen Tappo 50mm senza cornice	71-5770-14-00
Diffusor 1000 mm Diffusore 1000mm	71-5779-00-00
Diffusor 2000 mm Diffusore 2000mm	71-5780-00-00
Diffusor 3000 mm Diffusore 3000mm	71-5781-00-00
Unterputzset 1000 mm ohne Rahmen Kit da incasso 1000mm senza cornice	71-5788-00-00

Zubehör nicht inklusive / Accessori non inclusi	
LVE-Verbindungsset Kit unione LVE	71-5757-00-00
LVI-Verbindungsset Kit unione LVI	71-5758-00-00
I-Verbindungsset Kit unione I	71-5782-00-00
LH-Verbindungsset Kit unione LH	71-5783-00-00
T-Verbindungsset Kit unione T	71-5784-00-00
X-Verbindungsset Kit unione X	71-5785-00-00



Kundenspezifische Länge / Taglio su misura	
mm	Code
Custom size	71-5755 - 14 - 00L

*Alle kundenspezifisch zugeschnittenen Profile beinhalten Einbausatz, Deckel, Diffusoren und die erforderlichen Verbindungen. Die maximale Länge des Profils beträgt 3 Meter. Für größere Längen werden Verbindungssätze mitgeliefert, mit denen die gewünschte Größe hergestellt werden kann. Soweit möglich und bis zu einer Länge von 10 m wird der Diffusor in einem einzigen Stück ohne Schnitte geliefert. Kundenspezifische Längen: siehe S. 412

*Tutti i profili tagliati a misura includono un kit di installazione, coperchi, diffusori e le giunte necessarie. La misura massima del profilo è di 3 metri. Per le taglie più grandi saranno inclusi i kit di unione a "I" per poter costruire la misura desiderata. Per quanto possibile, e fino a 10m di lunghezza, il diffusore sarà servito in un'unica sezione, senza tagli. Per effettuare l'ordine di taglio a misura, consultare pag. 412

Empfohlene LED-Streifen / Strisce LED raccomandate	
Code	Description
91-7951-00-00	19,2W/m-3000K-Double LED
91-5572-00-00	28,8W/m-3000K

*Weitere Informationen: siehe Kollektion ON auf S. 425

*Per ulteriori opzioni, consultare la collezione ON a pag. 425

TAGLIO DI LUCE

Taglio di Luce Direct 66mm Trim

14 

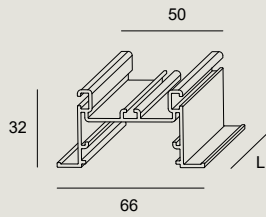

Standardgrößen / Misure standard		
mm	Code	
1000	71-8082	
2000	71-8083 - 14 - 00	
3000	71-8084	

Zubehör nicht inklusive und erforderlich / Accessori non inclusi e necessari		
Diffusor 10000 mm Diffusore 10000mm	71-5486-00-00	
Unterputzset 1000 mm Kit da incasso 1000mm	71-5511-00-00	
Diffusor 1000 mm Diffusore 1000mm	71-5779-00-00	
Diffusor 2000 mm Diffusore 2000mm	71-5780-00-00	
Diffusor 3000 mm Diffusore 3000mm	71-5781-00-00	
Endkappe 50 mm mit Rahmen Tappo finale 50mm con cornice	71-7640-14-00	

Zubehör nicht inklusive / Accessori non inclusi		
LVE-Verbindungsset Kit unione LVE	71-5757-00-00	
LVI-Verbindungsset Kit unione LVI	71-5758-00-00	
I-Verbindungsset Kit unione I	71-5782-00-00	
LH-Verbindungsset Kit unione LH	71-5783-00-00	
T-Verbindungsset Kit unione T	71-5784-00-00	
X-Verbindungsset Kit unione X	71-5785-00-00	



Kundenspezifische Länge / Taglio su misura		
mm	Code	
Custom size	71-8084 - 14 - 00L	

*Alle kundenspezifisch zugeschnittenen Profile beinhalten Einbausatz, Deckel, Diffusoren und die erforderlichen Verbindungen. Die maximale Länge des Profils beträgt 3 Meter. Für größere Längen werden Verbindungssätze mitgeliefert, mit denen die gewünschte Größe hergestellt werden kann. Soweit möglich und bis zu einer Länge von 10 m wird der Diffusor in einem einzigen Stück ohne Schnitte geliefert. Kundenspezifische Längen: siehe S. 412

*Tutti i profili tagliati a misura includono un kit di installazione, coperchi, diffusori e le giunte necessarie. La misura massima del profilo è di 3 metri. Per le taglie più grandi saranno inclusi i kit di unione a "I" per poter costruire la misura desiderata. Per quanto possibile, e fino a 10m di lunghezza, il diffusore sarà servito in un'unica sezione, senza tagli. Per effettuare l'ordine di taglio a misura, consultare pag. 412

Empfohlene LED-Streifen / Strisce LED raccomandate		
Code	Description	
91-7951-00-00	19,2W/m-3000K-Double LED	
91-5572-00-00	28,8W/m-3000K	

*Weitere Informationen: siehe Kollektion ON auf S. 425

*Per ulteriori opzioni, consultare la collezione ON a pag. 425

TAGLIO DI LUCE

Taglio di Luce Indirect Surface

Installationsschema
Schema di installazione

Oberfläche / In superficie

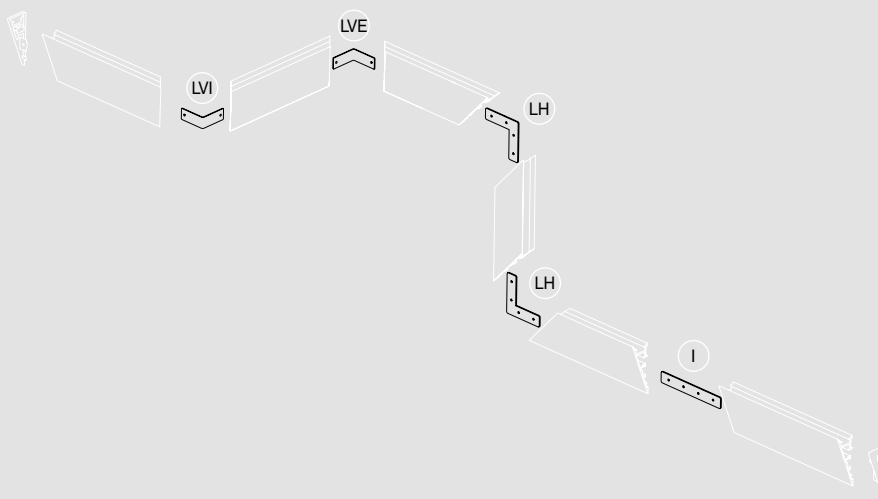

Verbinder LVI
Kit unione LVI
71-5758-00-00



Verbinder LVE
Kit unione LVE
71-5757-00-00



Verbinder LH
Kit unione LH
71-5783-00-00



Verbinder I
Kit di unione I
71-5782-00-00

TAGLIO DI LUCE

Taglio di Luce Indirect Surface

14 

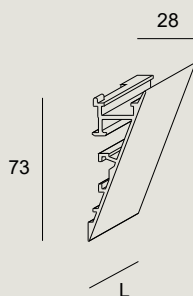

Standardgrößen / Misure standard		
mm	Code	
1000	71-5759	
2000	71-5760 - 14 - 00	
3000	71-5761	

Zubehör nicht inklusive und erforderlich / Accessori non inclusi e necessari	
Unterputzkappe Tappo incassato	71-5608-14-00
Befestigungsset Profil Kit fissaggio profilo	71-5756-14-00
Diffusor 1000 mm Diffusore 1000mm	71-5771-00-00
Diffusor 2000 mm Diffusore 2000mm	71-5772-00-00
Diffusor 3000mm Diffusore 3000mm	71-5773-00-00
Diffusor 10000 mm Diffusore 10000mm	71-5774-00-00

Zubehör nicht inklusive / Accessori non inclusi	
LVE-Verbindungsset Kit unione LVE	71-5757-00-00
LVI-Verbindungsset Kit unione LVI	71-5758-00-00
I-Verbindungsset Kit unione I	71-5782-00-00
LH-Verbindungsset Kit unione LH	71-5783-00-00



Kundenspezifische Länge / Taglio su misura	
mm	Code
Custom size	71-5761 - 14 - 00L

*Alle kundenspezifisch zugeschnittenen Profile beinhalten Einbausatz, Deckel, Diffusoren und die erforderlichen Verbindungen. Die maximale Länge des Profils beträgt 3 Meter. Für größere Längen werden Verbindungssätze mitgeliefert, mit denen die gewünschte Größe hergestellt werden kann. Soweit möglich und bis zu einer Länge von 10 m wird der Diffusor in einem einzigen Stück ohne Schnitte geliefert. Kundenspezifische Längen: siehe S. 412

*Tutti i profili tagliati a misura includono un kit di installazione, coperchi, diffusori e le giunte necessarie. La misura massima del profilo è di 3 metri. Per le taglie più grandi saranno inclusi i kit di unione a "I" per poter costruire la misura desiderata. Per quanto possibile, e fino a 10m di lunghezza, il diffusore sarà servito in un'unica sezione, senza tagli. Per effettuare l'ordine di taglio a misura, consultare pag. 412

Empfohlene LED-Streifen / Strisce LED raccomandate	
Code	Description
91-7929-00-00	19,2W/m-3000K
91-5572-00-00	28,8W/m-3000K

*Weitere Informationen: siehe Kollektion ON auf S. 425

*Per ulteriori opzioni, consultare la collezione ON a pag. 425

TAGLIO DI LUCE

Taglio di Luce Indirect Recessed

Installationsschema
Schema di installazione

Eingebaut / Ad incasso

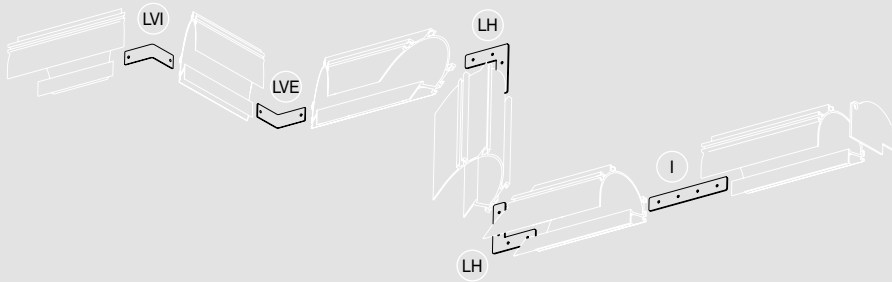

Verbinder LVI
Kit unione LVI
71-5758-00-00



Verbinder LVE
Kit unione LVE
71-5757-00-00



Verbinder LH
Kit unione LH
71-5783-00-00

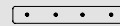

Verbinder I
Kit di unione I
71-5782-00-00

TAGLIO DI LUCE

Taglio di Luce Indirect Recessed

14 

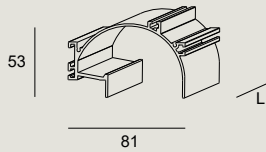

55xL



0-12 mm

Standardgrößen / Misure standard	
mm	Code
1000	71-5762
2000	71-5763 - 14 - 00
3000	71-5764

Zubehör nicht inklusive und erforderlich / Accessori non inclusi e necessari	
Unterputzkappe Tappo incassato	71-5609-14-00
Unterputzset 1000 mm ohne Rahmen Kit da incasso 1000mm senza cornice	71-5789-00-00

Zubehör nicht inklusive / Accessori non inclusi	
LVE-Verbindungsset Kit unione LVE	71-5757-00-00
LVI-Verbindungsset Kit unione LVI	71-5758-00-00
I-Verbindungsset Kit unione I	71-5782-00-00
LH-Verbindungsset Kit unione LH	71-5783-00-00



Kundenspezifische Länge / Taglio su misura	
mm	Code
Custom size	71-5764 - 14 - 00L

*Alle kundenspezifisch zugeschnittenen Profile beinhalten Einbausatz, Deckel, Diffusoren und die erforderlichen Verbindungen. Die maximale Länge des Profils beträgt 3 Meter. Für größere Längen werden Verbindungssätze mitgeliefert, mit denen die gewünschte Größe hergestellt werden kann. Soweit möglich und bis zu einer Länge von 10 m wird der Diffusor in einem einzigen Stück ohne Schnitte geliefert. Kundenspezifische Längen: siehe S. 412

*Tutti i profili tagliati a misura includono un kit di installazione, coperchi, diffusori e le giunte necessarie. La misura massima del profilo è di 3 metri. Per le taglie più grandi saranno inclusi i kit di unione a "I" per poter costruire la misura desiderata. Per quanto possibile, e fino a 10m di lunghezza, il diffusore sarà servito in un'unica sezione, senza tagli. Per effettuare l'ordine di taglio a misura, consultare pag. 412

Empfohlene LED-Streifen / Strisce LED raccomandate	
Code	Description
91-7939-00-00	19,2W/m-2700K-6500K
91-7938-00-00	19,2W/m-RGBW

*Weitere Informationen: siehe Kollektion ON auf S. 425

*Per ulteriori opzioni, consultare la collezione ON a pag. 425

Kundenspezifische Länge

Taglio su misura

Vorteile der kundenspezifischen Länge

Vantaggi del taglio su misura

Vorteile der kundenspezifischen Länge

Vantaggi del taglio su misura

Eine kundenspezifische Länge bestellen

Richiedere un taglio su misura

Beispiel für den Aufbau des Codes für eine kundenspezifische Länge:

Esempio di costruzione codice del taglio su misura:

Taglio di Luce lässt sich vollständig an Projekte anpassen. Bei der Bestellung bieten wir die Möglichkeit, gerade Stücke in eine kundenspezifische Länge zu schneiden.

Taglio di Luce è completamente adattabile ai progetti offrendo la possibilità di tagliare sezioni diritte a misura, al momento dell'ordine.

Bei dieser Option erhält der Kunde mit seiner Bestellung die genaue Anzahl der benötigten Taglio di Luce-Einheiten, wobei jede Länge mit einem Etikett gekennzeichnet ist, auf dem der Einsatzort des Profils angegeben ist.

Con questa opzione il cliente riceve l'ordine con il numero esatto di unità di Taglio di Luce di cui necessita ed ogni taglio viene identificato con un'etichetta che indica la zona di destinazione del prodotto.

Alle kundenspezifisch zugeschnittenen Profile beinhalten Einbausatz, Deckel, Diffusoren und die erforderlichen Verbindungen. Die maximale Länge des Profils beträgt 3 Meter. Für größere Längen werden Verbindungssätze mitgeliefert, mit denen die gewünschte Größe hergestellt werden kann. Soweit möglich und bis zu einer Länge von 10 m wird der Diffusor in einem einzigen Stück ohne Schnitte geliefert.

Tutti i profili tagliati a misura includono un kit di installazione, coperchi, diffusori e le giunte necessarie. La misura massima del profilo è di 3 metri. Per le taglie più grandi saranno inclusi i kit di unione a "I" per poter costruire la misura desiderata. Per quanto possibile, e fino a 10m di lunghezza, il diffusore sarà servito in un'unica sezione, senza tagli.

Zur Bestellung einer kundenspezifischen Länge müssen Sie den Produktcode mit folgenden Angaben erstellen:

1. Referenz.
2. L-Code, um „kundenspezifische Länge“ anzuzeigen.
3. Anzahl der geschnittenen Einheiten.
4. Länge jedes Profils in Metern (m).
5. Den auf der Verpackung zu kennzeichnenden Zielbereich angeben (optional).

Per richiedere il taglio a misura è necessario costruire il codice del prodotto specificando:

1. Il codice.
2. Il codice "L" che indica il "Taglio a misura".
3. Il numero di unità di taglio.
4. La lunghezza di ogni profilo in metri (m).
5. Scrivere l'area di destinazione che sarà riportata nell'imballaggio (opzionale).

Referenz Codice	Code für kundenspezifische Länge (L) Codice del taglio su misura (L)	St. Unità	Länge pro Einheit (mm) Lunghezza per unità (mm)	Identifikation (optional) Identificazione (opzionale)
71-5740-14-00	L	3	1500	Lounge2



LED-Bänder

Strisce LED

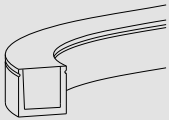

Asai

415

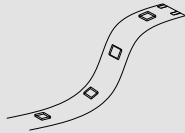

On

425



Asai



50000h

L80 B20



Kollektion bestehend aus einem flexiblen und widerstandsfähigen LED-Streifen mit dem sich endlose lineare Lichteffekte erzeugen lassen. Die Kollektion ist in 3 geschwungenen Formaten erhältlich: Side Bend, flexibel in der vertikalen Achse, Top Bend, flexibel in der horizontalen Achse und als Neuheit mit 3D-Flexibilität. Dank seiner Bauweise, die sowohl vertikale als auch horizontale Krümmungen zulässt, kann es an jede Art von Struktur angepasst werden. Durch diese Formbarkeit kann eine vollständige architektonische Integration in noch nie dagewesener Form erreicht werden.

Collezione composta da una striscia LED con corpo flessibile e resistente che permette di creare effetti luminosi lineari infiniti adattandosi a qualsiasi tipo di struttura, grazie alla sua composizione. È disponibile in 3 tipi di curvatura: Side Bend, flessibile sull'asse verticale, Top Bend, flessibile sull'asse orizzontale e, come novità, si offre con flessibilità 3D. Grazie alla plasticità del corpo dell'apparecchio, il progettista può disegnare forme finora impossibili, ottenendo una completa integrazione architettonica.

Asai Side Bend

Flexibel in der vertikalen Achse, wird diese Leuchte mit zwei Standardoptionen von 1 und 8 Metern präsentiert, die jeweils alle 10 Zentimeter geschnitten werden können.

Flessibile sull'asse verticale, è disponibile in due opzioni standard di 1 e 8 metri, che possono essere tagliati ogni 10 centimetri.



Asai Top Bend

Flexibel in der horizontalen Achse, ebenfalls mit der Option von 1 und 8 Metern, die jeweils alle 10 Zentimeter geschnitten werden können.

Flessibile sull'asse orizzontale, presenta anche l'opzione di 1 e 8 metri, con possibilità di taglio ogni 10 centimetri.



**Asai 3D: Größtmögliche
Anpassung**
Asai 3D: Massima versatilità

Dank seiner 3D-Formbarkeit und der Auswahl von Standardlängen 1 und 8 Metern, die alle 10 Zentimeter geschnitten werden können, lässt sich Asai 3D unabhängig von deren Form oder Beschaffenheit leicht an jede zu beleuchtende Oberfläche anpassen, was es zu einer idealen Lösung für alle Arten von Projekten macht.

Grazie alla sua flessibilità 3D ed alla sua disponibilità in misure standard di 1 e 8 metri che possono essere tagliate ogni 10 centimetri, Asai 3D si adatta facilmente ad ogni superficie da illuminare; tutto ciò, indipendentemente dalla sua forma o dalla superficie, diventando una soluzione ideale per tutti i tipi di progetti.

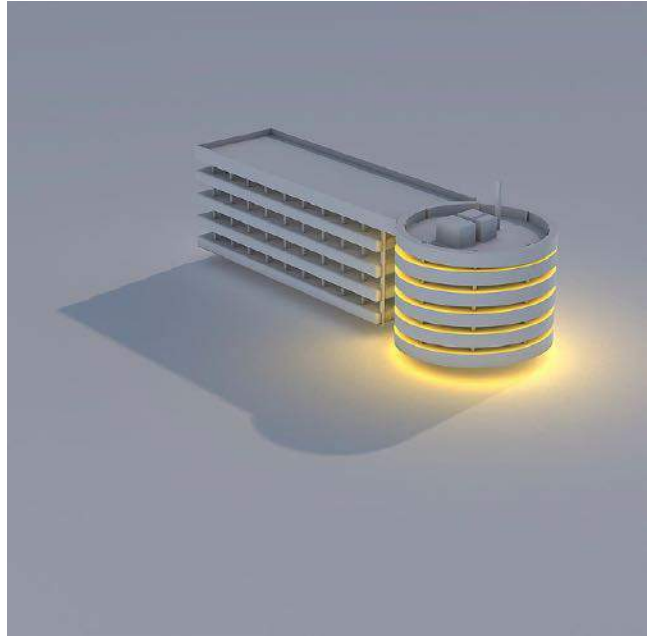

**Smart-Funktionen
Lichtatmosphären**
Funzionalità Smart Atmosfere
luminose

Durch die Kombination von Asai mit einem Konnektivitätsgerät kann die Lichtstärke reguliert und eine auf die Raumanforderungen abgestimmte, dynamische und flexible Farbwahl getroffen werden.

L'unione di Asai con un dispositivo connettivo consente di regolare il livello luminoso o di selezionare il colore più adatto alle esigenze dello spazio, offrendo così molto dinamismo e flessibilità.



Casambi PWM 1CH IP66|Casambi PWM 4CH IP20

Maximale Widerstandsfähigkeit Massima resistenza

Asai bietet garantierte Widerstandsfähigkeit mit IK10 und IP67 selbst in den Verbindungsstücken, sodass die Leuchte auch für Projekte im Außenbereich geeignet ist bei denen sie starken Umwelteinflüssen ausgesetzt ist.

Asai ha una resistenza garantita con un IK10 ed un IP67 che viene mantenuto anche nelle giunzioni. Si adatta, quindi, anche per progetti esterni con un forte impatto ambientale sull'apparecchio.

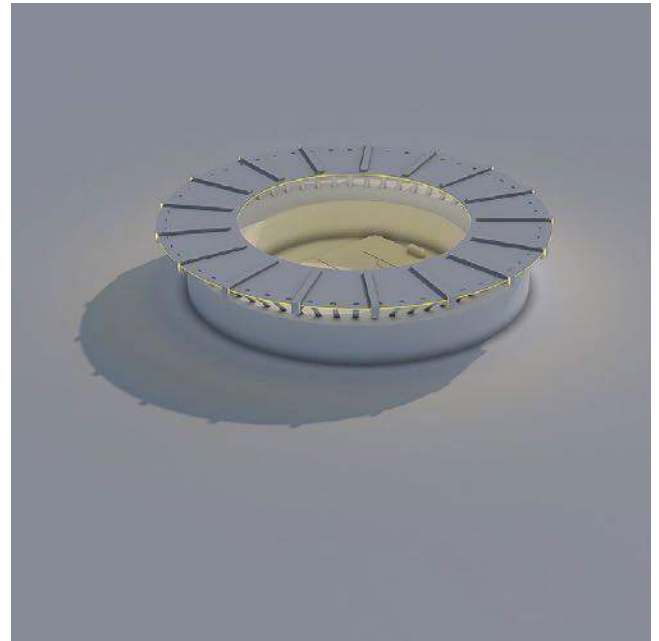

Optimale Installation Installazione ottimale

Die Aluminiumprofile garantieren eine optimale Installation, die gleichermaßen effektiv und widerstandsfähig ist.

I profili in alluminio garantiscono un'ottima installazione, essendo efficace e resistente in parti uguali.



ASAI

Asai Side Bend

BODY MAT	IP	IK	SC
PUR	67	10	8 m

00 

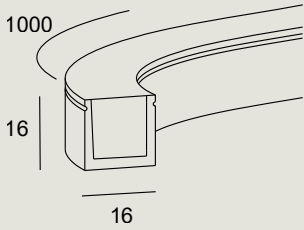

LED						
K	CRI	W LED	Real Lm	W/1m	mm	Code
3000	80	14.4	441	14.4	1000	91-6607 - 00 - 00
4000	80	14.4	498	14.4	1000	91-7964 - 00 - 00
RGB		14.4	194	14.4	1000	91-7968 - 00 - 00

 24VDC

 P. 944

nicht inklusive / Non incluso	
Klammern x 20 Clips x 20	71-6607-00-00
2 m flexibles Profil Profilo 2m flessibile	71-7698-00-00
5-m-Kabel mit wasserdichten Schnellsteckverbindern Cavo da 5m con connettori rapidi a tenuta stagna	71-E004-00-00
5-m-Kabel mit wasserdichten Schnellsteckverbindern RGB Cavo da 5m con connettori rapidi a tenuta stagna RGB	71-E005-00-00
1-m-Kabel mit wasserdichten Schnellsteckverbindern Cavo da 1m con connettori rapidi a tenuta stagna	71-E034-00-00
1-m-Kabel mit wasserdichten Schnellsteckverbindern RGB Cavo da 1m con connettori rapidi a tenuta stagna RGB	71-E071-00-00

Smart Compatible-Zub. / Access. Smart Compatibile	
71-8050-00-00	Dimmer Casambi PWM 4ch IP20
71-A242-00-00	Driver Casambi PWM 1ch IP66

ASAI

Asai Side Bend

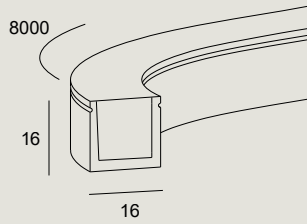

BODY MAT	IP	IK	*** + ***	(SC)
PUR	67	10	8 m	

00 ○

LED						
K	CRI	W LED	Real Lm	W/1m	mm	Code
3000	80	115.2	3529	14.4	8000	91-6608 - 00 - 00
4000	80	115.2	3988	14.4	8000	91-7965 - 00 - 00
RGB		115.2	1552	14.4	8000	91-7969 - 00 - 00

24VDC

ⓘ P. 944

nicht inklusive / Non incluso	
Klammern x 20 Clips x 20	71-6607-00-00
2 m flexibles Profil Profilo 2m flessibile	71-7698-00-00
5-m-Kabel mit wasserdichten Schnellsteckverbindern Cavo da 5m con connettori rapidi a tenuta stagna	71-E004-00-00
5-m-Kabel mit wasserdichten Schnellsteckverbindern RGB Cavo da 5m con connettori rapidi a tenuta stagna RGB	71-E005-00-00
1-m-Kabel mit wasserdichten Schnellsteckverbindern Cavo da 1m con connettori rapidi a tenuta stagna	71-E034-00-00
1-m-Kabel mit wasserdichten Schnellsteckverbindern RGB Cavo da 1m con connettori rapidi a tenuta stagna RGB	71-E071-00-00

Smart Compatible-Zub. / Access. Smart Compatibile	
71-8050-00-00	Dimmer Casambi PWM 4ch IP20
71-A242-00-00	Driver Casambi PWM 1ch IP66

ASAI

Asai Top Bend

BODY MAT	IP	IK	SC
PUR	67	10	8 m

00 

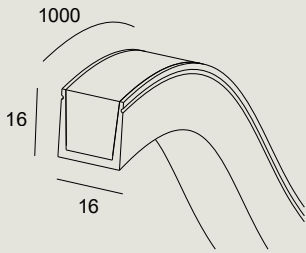

LED						
K	CRI	W LED	Real Lm	W/1m	mm	Code
3000	80	14.4	441	14.4	1000	91-6609 - 00 - 00
4000	80	14.4	498	14.4	1000	91-7966 - 00 - 00
RGB		14.4	194	14.4	1000	91-7970 - 00 - 00

 24VDC

 P. 944

nicht inklusive / Non incluso	
Klammern x 20 Clips x 20	71-6607-00-00
2 m starr Profil Profilo 2m rigido	71-6608-00-00
2 m flexibles Profil Profilo 2m flessibile	71-7698-00-00
5-m-Kabel mit wasserdichten Schnellsteckverbindern Cavo da 5m con connettori rapidi a tenuta stagna	71-E004-00-00
5-m-Kabel mit wasserdichten Schnellsteckverbindern RGB Cavo da 5m con connettori rapidi a tenuta stagna RGB	71-E005-00-00
1-m-Kabel mit wasserdichten Schnellsteckverbindern Cavo da 1m con connettori rapidi a tenuta stagna	71-E034-00-00
1-m-Kabel mit wasserdichten Schnellsteckverbindern RGB Cavo da 1m con connettori rapidi a tenuta stagna RGB	71-E071-00-00

Smart Compatible-Zub. / Access. Smart Compatibile	
71-8050-00-00	Dimmer Casambi PWM 4ch IP20
71-A242-00-00	Driver Casambi PWM 1ch IP66

ASAI

Asai Top Bend

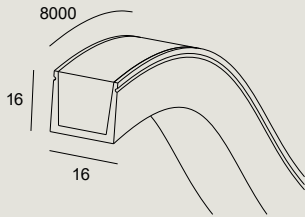

BODY MAT	IP	IK	*** + ***	(SC)
PUR	67	10	8 m	

00

LED						
K	CRI	W LED	Real Lm	W/1m	mm	Code
3000	80	115.2	3529	14.4	8000	91-6610 - 00 - 00
4000	80	115.2	3988	14.4	8000	91-7967 - 00 - 00
RGB		115.2	1552	14.4	8000	91-7971 - 00 - 00

24VDC

P. 944

nicht inklusive / Non incluso	
Klammern x 20 Clips x 20	71-6607-00-00
2 m starr Profil Profilo 2m rigido	71-6608-00-00
2 m flexibles Profil Profilo 2m flessibile	71-7698-00-00
5-m-Kabel mit wasserdichten Schnellsteckverbindern Cavo da 5m con connettori rapidi a tenuta stagna	71-E004-00-00
5-m-Kabel mit wasserdichten Schnellsteckverbindern RGB Cavo da 5m con connettori rapidi a tenuta stagna RGB	71-E005-00-00
1-m-Kabel mit wasserdichten Schnellsteckverbindern Cavo da 1m con connettori rapidi a tenuta stagna	71-E034-00-00
1-m-Kabel mit wasserdichten Schnellsteckverbindern RGB Cavo da 1m con connettori rapidi a tenuta stagna RGB	71-E071-00-00

Smart Compatible-Zub. / Access. Smart Compatibile	
71-8050-00-00	Dimmer Casambi PWM 4ch IP20
71-A242-00-00	Driver Casambi PWM 1ch IP66

ASAI

Asai 3D

BODY MAT	IP	IK	☐☐☐☐☐☐	(SC)
PVC	67	10	8 m	

00 ○

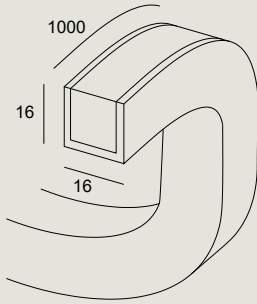

LED						
K	CRI	W LED	Real Lm	W/1m	mm	Code
3000	80	14.4	441	14.4	1000	91-A000 - 00 - 00
4000	80	14.4	498	14.4	1000	91-A002 - 00 - 00
RGB		14.4	194	14.4	1000	91-A004 - 00 - 00

 24VDC

ⓘ P. 944

nicht inklusive / Non incluso	
Klammern x 20 Clips x 20	71-6607-00-00
2 m starr Profil Profilo 2m rigido	71-6608-00-00
2 m flexibles Profil Profilo 2m flessibile	71-7698-00-00
5-m-Kabel mit wasserdichten Schnellsteckverbindern Cavo da 5m con connettori rapidi a tenuta stagna	71-E004-00-00
5-m-Kabel mit wasserdichten Schnellsteckverbindern RGB Cavo da 5m con connettori rapidi a tenuta stagna RGB	71-E005-00-00
1-m-Kabel mit wasserdichten Schnellsteckverbindern Cavo da 1m con connettori rapidi a tenuta stagna	71-E034-00-00
1-m-Kabel mit wasserdichten Schnellsteckverbindern RGB Cavo da 1m con connettori rapidi a tenuta stagna RGB	71-E071-00-00

Smart Compatible-Zub. / Access. Smart Compatibile	
71-8050-00-00	Dimmer Casambi PWM 4ch IP20
71-A242-00-00	Driver Casambi PWM 1ch IP66

ASAI

Asai 3D

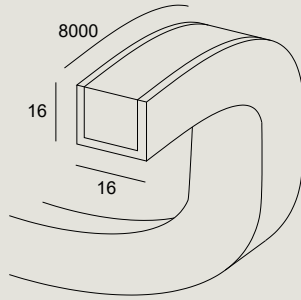

BODY MAT	IP	IK	*** + **	(SC)
PVC	67	10	8 m	

00

LED						
K	CRI	W LED	Real Lm	W/1m	mm	Code
3000	80	115.2	3529	14.4	8000	91-A001 - 00 - 00
4000	80	115.2	3988	14.4	8000	91-A003 - 00 - 00
RGB		115.2	1552	14.4	8000	91-A005 - 00 - 00

24VDC

P. 944

nicht inklusive / Non incluso	
Klammern x 20 Clips x 20	71-6607-00-00
2 m starr Profil Profilo 2m rigido	71-6608-00-00
2 m flexibles Profil Profilo 2m flessibile	71-7698-00-00
5-m-Kabel mit wasserdichten Schnellsteckverbindern Cavo da 5m con connettori rapidi a tenuta stagna	71-E004-00-00
5-m-Kabel mit wasserdichten Schnellsteckverbindern RGB Cavo da 5m con connettori rapidi a tenuta stagna RGB	71-E005-00-00
1-m-Kabel mit wasserdichten Schnellsteckverbindern Cavo da 1m con connettori rapidi a tenuta stagna	71-E034-00-00
1-m-Kabel mit wasserdichten Schnellsteckverbindern RGB Cavo da 1m con connettori rapidi a tenuta stagna RGB	71-E071-00-00

Smart Compatible-Zub. / Access. Smart Compatibile	
71-8050-00-00 Dimmer Casambi PWM 4ch IP20	
71-A242-00-00 Driver Casambi PWM 1ch IP66	



On



50000h
L80 B20



Verschiedene Optionen für jeden Bedarf
Diverse opzioni per ogni necessità



Eine Kollektion von flexiblen Streifen mit einer Vielzahl verschiedener Leistungen und Optionen, um Effekte jeder Art zu erzielen. Die Streifen stehen für verschiedene Optionen zur Verfügung: Basic für einfache Lichtlösungen, Performance mit anspruchsvolleren Leistungen und Advanced für sehr spezifische und konkrete Anforderungen.

Collezione di strisce flessibili con una vasta gamma di potenze ed opzioni che permettono di ottenere qualsiasi effetto. Le strisce sono dotate di un'opzione Basic, per soluzioni semplici, Performance, con prestazioni superiori e Advanced, per esigenze molto specifiche e concrete.

Die Kollektion ist je nach den primären Projektanforderungen in drei Komplexitätsstufen unterteilt: Basic, Performance und Advanced.

La collezione si presenta in tre livelli di complessità a seconda della necessità del progetto: Basic, Performance e Advanced.



Smart Compatible-Funktion
Funzionalità Smart Compatible

Dank der Smart Compatible Versionen können je nach den Anforderungen an die Kommunikation und des Raumkonzepts Lichtszenen programmiert werden.

Grazie alle versioni Smart Compatible è possibile la programmazione di scene luminose in base alle esigenze di comunicazione e al concetto dello spazio.



ON BASIC



Hohe Farbwiedergabe Elevata resa cromatica

Spezifische Lösungen für konkrete Anforderungen.
Soluzioni specifiche per richieste concrete.

Mit Farbwiedergabeindex von über 80. Erhältlich als IP20- sowie als IP65-Version durch optionales Zubehör. Erhältlich in verschiedenen Leistungsstufen zur optimalen Anpassung an jede Anforderung: 4,8 W, 9,6 W, 14,4 W, 19,2 W, und 28,8 W. Hanno un indice di resa cromatica superiore a 80 e sono disponibili nelle versioni IP20 ed IP65 mediante l'installazione di un accessorio opzionale. Propongono diversi livelli di potenza per adattarsi ad ogni necessità: 4,8W, 9,6W, 14,4W, 19,2W, y 28,8W.



ON PERFORMANCE



RGBW-Lösungen Soluzioni RGBW

Höhere Leistung und Farbwiedergabe von mindestens 90.
Gamma di prestazioni superiori e una riproduzione cromatica minima di 90.

On Performance verfügt über spezifische Lösungen für Farbtemperaturwechsel oder RGBW.
On Performance dispone di soluzioni specifiche per il cambio di temperatura o per RGBW.



ON ADVANCED



Spezifische Lösungen für konkrete Anforderungen.
Soluzioni specifiche per richieste concrete.

Advanced CRI98

Farbwiedergabeindex über 98, für lebhaftere und attraktive Farben, ideal für den Einzelhandel.

Indice di resa cromatica maggiore di 98, per ottenere colori vivaci ed intensi, ideali per spazi Retail.



Advanced 160 Lm/W

Hoher Lichtstrom mit 160 lm/W ideal, geeignet als einzigen Lichtpunkt der Anlage.

Soluzione ad alto flusso luminoso con 160 lm/W, ideale per un unico uso, come unico punto luminoso dell'installazione.



Advanced THIN 4mm

Geringe Breite für unterschwellige Effekte und minimalistische Installationen.

Larghezza ridotta per effetti sottili ed installazioni minimaliste.



Advanced High Density 240 LED/MT

Hohe LED-Dichte von 240 x m für kontinuierliche lineare Installationen mit Taglio di Luce.

Alta densità di LED 240 x mt, ideale per installazioni lineari continue, con Taglio di luce.



Advanced Double LED

Doppelte Dichte für breite Profile, kontinuierlicher Effekt für Profile mit Taglio di Luce von 35/50 mm.

Doppia densità per profili ampi, effetto continuo ideale per profili Taglio di luce, da 35/50mm.



Kundenspezifische Länge

Taglio su misura

Vorteile des kundenspezifischen Größe
Vantaggi del taglio su misura

Voraussetzungen
Condizioni d'uso

Funktionsweise
Come funziona?

Beispiel für den Aufbau des Codes für kundenspezifische Länge:
Esempio di costruzione del codice del tagliopersonalizzato:

Referenz Codice	Code für kundenspezifische Länge (L) Codice del taglio su misura (L)	St. Unità	Länge pro Einheit (mm) Lunghezza per unità (mm)	Identifikation (optional) Identificazione (opzionale)
91-7906-00-00	L	3	1500	Room

Wenn Sie einen LED-Streifen in einer spezifischen Größe benötigen, können Sie bei der Bestellung ein gerades Stück in der gewünschten Länge anfordern.

Se ha bisogno di una striscia LED con una misura speciale, puoi richiedere una sezione in linea retta su misura, all'effettuare l'ordine.

Die Maße passen exakt zu Ihrem Projekt. Sie erhalten mit Ihrer Bestellung die benötigte Anzahl an LED-Streifen. Sie können jeden Schnitt mit einem Etikett mit dem von Ihnen gewünschten Namen des Zielbereichs.

Ottenere la misura esatta di cui ha bisogno per il suo progetto. Riceverà l'ordine secondo il numero di unità di strisce LED necessarie. Potrà identificare ogni taglio con un'etichetta che indica il nome del luogo di destinazione o della zona desiderata.

Die angeforderte Größe muss ein Vielfaches der Mindestschnittlänge des angegebenen Produkts sein, welche in der Code-Tabelle für kundenspezifische Schnitte angegeben ist. Die maximale Länge des Streifens darf nicht größer sein als die maximal zulässige Reihenschaltung, welche in der Code-Tabelle für kundenspezifische Schnitte angegeben ist. Alle Produkte mit kundenspezifischer Schnittlänge haben an einer Seite ein 20 cm langes Anschlusskabel. Je nach Produkt können Rollen von bis zu 50 m Länge bestellt werden. Wenden Sie sich an das Kundendienstteam.

La misura richiesta deve essere multipla al taglio minimo del codice di riferimento scelto, indicata nella tabella del taglio su misura. La lunghezza massima di taglio non può essere superiore alla misura massima della connessione in serie, indicata nella tabella del taglio su misura. Tutti i prodotti tagliati su misura includeranno 20cm di cavo ad un'estremità per una facile connessione. Le bobine fino a 50m possono essere ordinate in base al codice di riferimento. Verificare con il team del servizio clienti.

Zur Bestellung einer kundenspezifischen Länge müssen Sie den Produktcode mit folgenden Angaben erstellen:

1. Referenz.
2. L-Code, um „kundenspezifische Länge“ anzuzeigen.
3. Anzahl der geschnittenen Einheiten.
4. Die Länge jedes Streifens in Millimetern (mm).
5. Zielbereich zum Aufdruck auf das Etikett der Verpackung angeben (optional).

Per richiedere il taglio personalizzato è necessario creare il codice del prodotto specificando:

1. Il codice di riferimento.
2. Il codice "L" che indica "Taglio su misura".
3. Il numero di unità di taglio.
4. La misura totale in millimetri (mm).
5. Scrivere la destinazione che sarà indicata nell'imballaggio (opzionale).

ON

On Basic 4,8

BODY MAT	IP	3	••• + •••	(SC)
AL	20	MacAdam	10 m	

00 

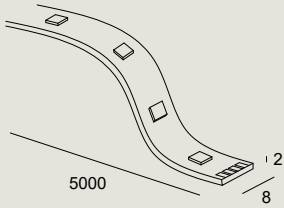

LED						
K	CRI	W LED	Real Lm	W/1m	Real Lm/1m	Code
2700	80	26	3088	5.2	618	91-7908 - 00 - 00
3000	80	26	3212	5.2	642	91-7909 - 00 - 00
4000	80	23	2571	4.6	514	91-7910 - 00 - 00
6000	80	23	2764	4.6	553	91-7911 - 00 - 00

 24VDC

 P. 942

ON

On Basic 4,8 Custom size

BODY MAT	IP	3	••• + •••	(SC)	
AL	20	MacAdam	10 m		

00 

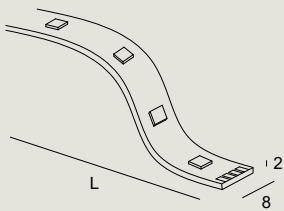

LED							
K	CRI	W/1m	Real Lm/1m	Size (mm)	Min. cutting length (mm.)	Maximum xm.	Code
2700	80	5.2	618	50000	100	10	91-7908 - 00 - 00L
3000	80	5.2	642	50000	100	10	91-7909 - 00 - 00L
4000	80	4.6	514	50000	100	10	91-7910 - 00 - 00L
6000	80	4.6	553	50000	100	10	91-7911 - 00 - 00L

 24VDC

 P. 942

nicht mitgeliefertes
allgemeines Zub.
Access. comuni non inclusi

Starter x 5u
Starter x 5u

71-8092-00-00

Junction x 5u
Junction x 5u

71-8093-00-00

Acc. Smart Compatible
Ac. Smart Compatible

Driver Casambi PWM 1ch IP66

71-A242-00-00

ON

On Basic 4,8

BODY MAT	IP	3		BREEAM	(SC)
AL	65	MacAdam	8 m		

00

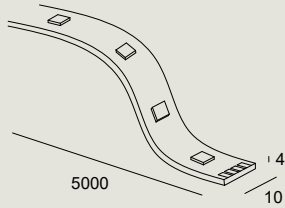

LED						
K	CRI	W LED	Real Lm	W/1m	Real Lm/1m	Code
2700	80	26	1820	5.2	463	91-7912 - 00 - 00
3000	80	26	1890	5.2	481	91-7913 - 00 - 00
4000	80	23	1965	4.6	386	91-7914 - 00 - 00
6000	80	23	2438	4.6	514	91-7915 - 00 - 00

24VDC

P. 942

ON

On Basic 4,8 Custom size

BODY MAT	IP	3		BREEAM	(SC)	
AL	65	MacAdam	8 m			

00

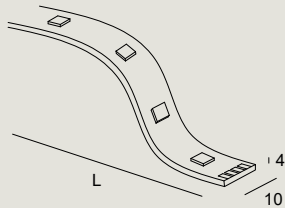

LED							
K	CRI	W/1m	Real Lm/1m	Size (mm)	Min. cutting length (mm.)	Maximum xm.	Code
2700	80	5.2	463	10000	100	8	91-7912 - 00 - 00L
3000	80	5.2	481	10000	100	8	91-7913 - 00 - 00L
4000	80	4.6	386	10000	100	8	91-7914 - 00 - 00L
6000	80	4.6	514	10000	100	8	91-7915 - 00 - 00L

24VDC

P. 942

**nicht mitgeliefertes
allgemeines Zub.**
Access. comuni non inclusi

Starter x 5u
Starter x 5u

71-8094-00-00

Junction x 5u
Junction x 5u

71-8095-00-00

Smart Compatible-Zub.
Access. Smart Compatibile

Driver Casambi PWM 1ch IP66

71-A242-00-00

ON

On Basic 9,6

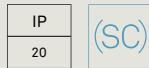

00

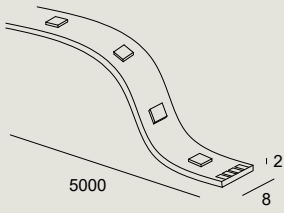

LED						
K	CRI	W LED	Real Lm	W/1m	Real Lm/1m	Code
2500	80	48	4210	9.6	842	91-3282 - 00 - 00
2700	80	48	4385	9.6	877	91-7916 - 00 - 00
3000	80	48	5113	9.6	1023	91-7917 - 00 - 00
4000	80	48	4736	9.6	947	91-7918 - 00 - 00
6000	80	48	4736	9.6	947	91-7919 - 00 - 00
RGB		48	2607	9.6	521	91-7920 - 00 - 00

24VDC

P. 942

ON

On Basic 9,6 Custom size

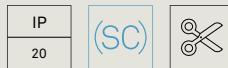

00

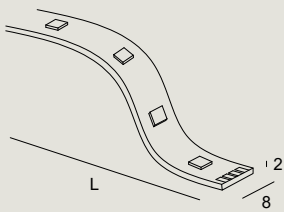

LED							
K	CRI	W/1m	Real Lm/1m	Size (mm)	Min. cutting length (mm.)	Maximum xm.	Code
2500	80	9.6	842	50000	50	8	91-3282 - 00 - 00L
2700	80	9.6	983	50000	50	8	91-7916 - 00 - 00L
3000	80	9.6	1023	50000	50	8	91-7917 - 00 - 00L
4000	80	9.6	1062	50000	50	8	91-7918 - 00 - 00L
6000	80	9.6	1062	50000	50	8	91-7919 - 00 - 00L
RGB		9.6	521	50000	100	8	91-7920 - 00 - 00L

24VDC

P. 942

**nicht mitgeliefertes
allgemeines Zub.**
Access. comuni non inclusi

Starter x 5u
Starter x 5u **71-8092-00-00**

Junction x 5u
Junction x 5u **71-8093-00-00**

Starter RGB x 5u
Starter RGB x 5u **71-8096-00-00**

Junction RGB x 5u
Junction RGB x 5u **71-8097-00-00**

Smart Compatible-Zub.
Access. Smart Compatibile

Dimmer Casambi PWM 4ch IP20 **71-8050-00-00**

Driver Casambi PWM 1ch IP66 **71-A242-00-00**

ON

On Basic 9,6

BODY MAT	IP		BREEAM	
AL	65	6 m		

00

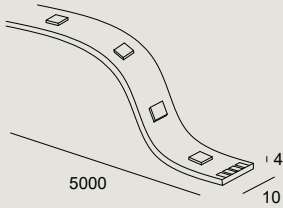

LED						
K	CRI	W LED	Real Lm	W/1m	Real Lm/1m	Code
2700	80	48	4079	9.6	816	91-7921 - 00 - 00
3000	80	48	4242	9.6	848	91-7922 - 00 - 00
4000	80	48	4404	9.6	881	91-7923 - 00 - 00
6000	80	48	4404	9.6	881	91-7924 - 00 - 00
RGB		48	2427	9.6	485	91-7925 - 00 - 00

24VDC

P. 942

ON

On Basic 9,6 Custom size

BODY MAT	IP			
AL	65	6 m		

00

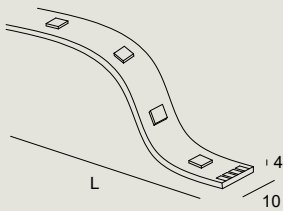

LED							
K	CRI	W/1m	Real Lm/1m	Size (mm)	Min. cutting length (mm.)	Maximum xm.	Code
2700	80	9.6	816	10000	50	6	91-7921 - 00 - 00L
3000	80	9.6	848	10000	50	6	91-7922 - 00 - 00L
4000	80	9.6	881	10000	50	6	91-7923 - 00 - 00L
6000	80	9.6	881	10000	50	6	91-7924 - 00 - 00L
RGB		9.6	243	10000	100	6	91-7925 - 00 - 00L

24VDC

P. 942

nicht mitgeliefertes allgemeines Zub.
Access. comuni non inclusi

Starter x 5u
Starter x 5u 71-8094-00-00

Junction x 5u
Junction x 5u 71-8095-00-00

Starter RGB x 5u
Starter RGB x 5u 71-8098-00-00

Junction RGB x 5u
Junction RGB x 5u 71-8099-00-00

Smart Compatible-Zub.
Access. Smart Compatibile

Dimmer Casambi PWM 4ch IP20 71-8050-00-00

Driver Casambi PWM 1ch IP66 71-A242-00-00

ON

On Basic 14,4

IP	(SC)
20	

00 

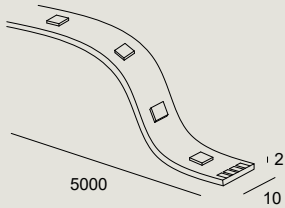

LED						
K	CRI	W LED	Real Lm	W/1m	Real Lm/1m	Code
2700	80	58	8420	11.6	1684	91-7926 - 00 - 00
3000	80	58	8757	11.6	1751	91-7927 - 00 - 00
RGB		72	4755	14.4	951	91-2379 - 00 - 00

 24VDC

 P. 942

ON

On Basic 14,4 Custom size

IP	(SC)	
20		

00 

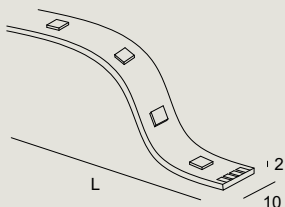

LED							
K	CRI	W/1m	Real Lm/1m	Size (mm)	Min. cutting length (mm.)	Maximum xm.	Code
2700	80	11.6	1684	50000	50	7	91-7926 - 00 - 00L
3000	80	11.6	1751	50000	50	7	91-7927 - 00 - 00L
RGB		14.4	951	50000	100	6	91-2379 - 00 - 00L

 24VDC

 P. 942

**nicht mitgeliefertes
allgemeines Zub.**
Access. comuni non inclusi

Starter x 5u
Starter x 5u

71-8100-00-00

Junction x 5u
Junction x 5u

71-8101-00-00

Smart Compatible-Zub.
Access. Smart Compatibile

Dimmer Casambi PWM 4ch IP20
Driver Casambi PWM 1ch IP66

71-8050-00-00
71-A242-00-00

ON

On Basic 19,2

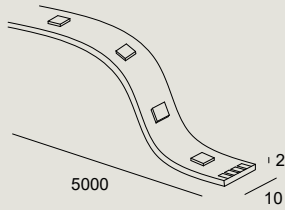

BODY MAT	IP	3	••• + •••	(SC)
AL	20	MacAdam	5 m	

00 ○

LED						
K	CRI	W LED	Real Lm	W/1m	Real Lm/1m	Code
2700	80	79	11173	15.8	2235	91-7928 - 00 - 00
3000	80	79	11443	15.8	2289	91-7929 - 00 - 00

24VDC

① P. 942

ON

On Basic 19,2 Custom size

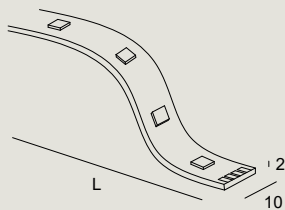

BODY MAT	IP	3	••• + •••	(SC)	
AL	20	MacAdam	5 m		

00 ○

LED							
K	CRI	W/1m	Real Lm/1m	Size (mm)	Min. cutting length (mm.)	Maximum xm.	Code
3000	80	15.8	2235	50000	62.5	5	91-7928 - 00 - 00L
3000	80	15.8	2289	50000	62.5	5	91-7929 - 00 - 00L

24VDC

① P. 942

ON

On Basic 19,2

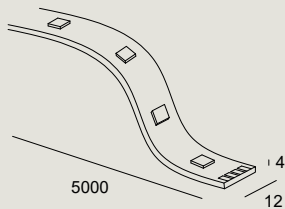

IP	3	••• + •••	(SC)
65	MacAdam	5 m	

00 ○

LED						
K	CRI	W LED	Real Lm	W/1m	Real Lm/1m	Code
3000	80	79	11620	15.8	2324	91-5567 - 00 - 00

24VDC

① P. 942

ON

On Basic 19,2 Custom size

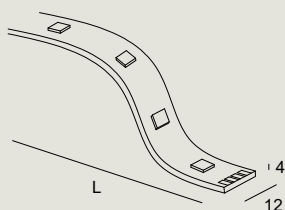

IP	3	••• + •••	(SC)	
65	MacAdam	5 m		

00 ○

LED							
K	CRI	W/1m	Real Lm/1m	Size (mm)	Min. cutting length (mm.)	Maximum xm.	Code
3000	80	15.8	2324	10000	62.5	5	91-5567 - 00 - 00L

24VDC

① P. 942

nicht mitgeliefertes
allgemeines Zub.
Access. comuni non inclusi

Starter x 5u 71-8100-00-00
Starter x 5u

Junction x 5u 71-8101-00-00
Junction x 5u

Smart Compatible-Zub.
Access. Smart Compatibile

Driver Casambi PWM 1ch IP66 71-A242-00-00

ON

On Basic 28,8

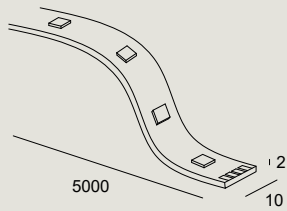

00

LED						
K	CRI	W LED	Real Lm	W/1m	Real Lm/1m	Code
2700	80	168	15060	33.6	3012	91-5571 - 00 - 00
3000	80	154	14810	30.8	2962	91-5572 - 00 - 00
4000	80	125	17080	25	3416	91-5573 - 00 - 00

24VDC

P. 942

ON

On Basic 28,8 Custom size

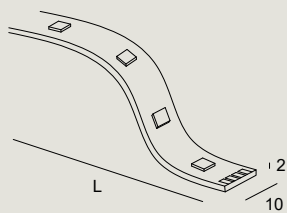

IP	3			
20	MacAdam	5 m		

00

LED							
K	CRI	W/1m	Real Lm/1m	Size (mm)	Min. cutting lenght (mm.)	Maximum xm.	Code
2700	80	33.6	3012	5000	42	5	91-5571 - 00 - 00L
3000	80	30.8	2962	5000	42	5	91-5572 - 00 - 00L
4000	80	25	3416	5000	42	5	91-5573 - 00 - 00L

24VDC

P. 942

**nicht mitgeliefertes
allgemeines Zub.**
Access. comuni non inclusi

Starter x 5u
Starter x 5u

71-8092-00-00

Junction x 5u
Junction x 5u

71-8093-00-00

Smart Compatible-Zub.
Access. Smart Compatibile

Driver Casambi PWM 1ch IP66

71-A242-00-00

ON

On Performance 9,6

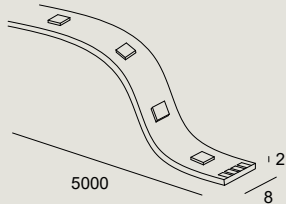

BODY MAT	IP	3	••• + •••	(SC)
AL	20	MacAdam	6 m	

00 ○

LED						
K	CRI	W LED	Real Lm	W/1m	Real Lm/1m	Code
2700	90	53	5218	10.6	1044	91-7930 - 00 - 00
3000	90	46	5203	9.2	1041	91-7931 - 00 - 00

24VDC

P. 942

ON

On Performance 9,6 Custom size

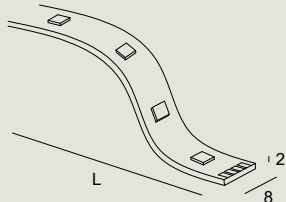

BODY MAT	IP	3	••• + •••	(SC)	
AL	20	MacAdam	6 m		

00 ○

LED							
K	CRI	W/1m	Real Lm/1m	Size (mm)	Min. cutting length (mm.)	Maximum xm.	Code
2700	90	10.6	1044	50000	50	6	91-7930 - 00 - 00L
3000	90	9.2	1041	50000	50	6	91-7931 - 00 - 00L

24VDC

P. 942

ON

On Performance 14,4

BODY MAT	IP	3		
AL	20	MacAdam	6 m	

00

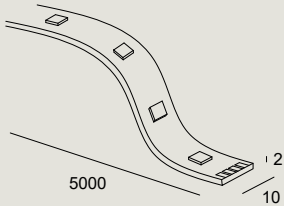

LED						
K	CRI	W LED	Real Lm	W/1m	Real Lm/1m	Code
2700	90	67	6446	13.4	1289	91-7932 - 00 - 00
3000	90	42	6081	8.4	1216	91-7933 - 00 - 00

P. 942

ON

On Performance 14,4 Custom size

BODY MAT	IP	3			
AL	20	MacAdam	6 m		

00

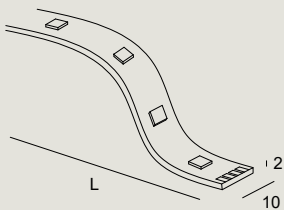

LED							
K	CRI	W/1m	Real Lm/1m	Size (mm)	Min. cutting length (mm.)	Maximum xm.	Code
2700	90	13.4	1289	50000	50	6	91-7932 - 00 - 00L
3000	90	8.4	1216	50000	50	6	91-7933 - 00 - 00L

P. 942

ON

On Performance 19,2

BODY MAT	IP	5m	(SC)
AL	20	5 m	

00 

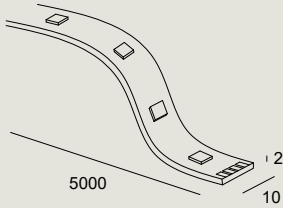

LED							
K	CRI	W LED	Real Lm	W/1m	Real Lm/1m	Code	
2700	90	103	13600	20.6	2720	91-7934 - 00 - 00	
3000	90	74	10060	14.8	2012	91-7935 - 00 - 00	
4000	90	101	14150	20.2	2830	91-7936 - 00 - 00	
RGB		122	13030	24.4	2606	91-7937 - 00 - 00	
TW 2700-6500	90	96	7973	19.2	1595	91-7939 - 00 - 00	
TW RGB-3000	90	96	4574	19.2	915	91-7938 - 00 - 00	

 24VDC

 P. 942

ON

On Performance 19,2 Custom size

BODY MAT	IP	5m	(SC)	
AL	20	5 m		

00 

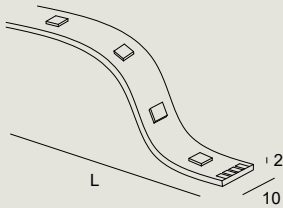

LED							
K	CRI	W/1m	Real Lm/1m	Size (mm)	Min. cutting length (mm.)	Maximum xm.	Code
2700	90	20.6	2720	50000	62.5	5	91-7934 - 00 - 00L
3000	90	14.8	2012	50000	62.5	5	91-7935 - 00 - 00L
4000	90	20.2	2830	50000	62.5	5	91-7936 - 00 - 00L
RGB		24.4	2606	50000	71	5	91-7937 - 00 - 00L
TW 2700-6500	90	19.2	1595	50000	125	5	91-7939 - 00 - 00L
TW RGB-3000	90	19.2	915	50000	125	5	91-7938 - 00 - 00L

 24VDC

 P. 942

Smart Compatible-Zub.
Access. Smart Compatible

Dimmer Casambi PWM 4ch IP20
Driver Casambi PWM 1ch IP66

71-8050-00-00
71-A242-00-00

ON

On Performance 28,8

BODY MAT	IP	3	☐ + ☐ + ☐	(SC)
AL	20	MacAdam	5 m	

00 ○

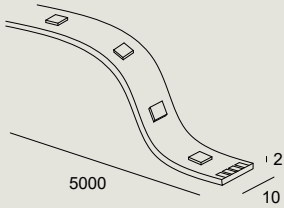

LED						
K	CRI	W LED	Real Lm	W/1m	Real Lm/1m	Code
2700	90	122	13030	24.4	2606	91-7940 - 00 - 00
3000	90	122	13030	24.4	2606	91-7941 - 00 - 00

24VDC

ⓘ P. 942

ON

On Performance 28,8 Custom size

BODY MAT	IP	3	☐ + ☐ + ☐	(SC)	✂
AL	20	MacAdam	5 m		

00 ○

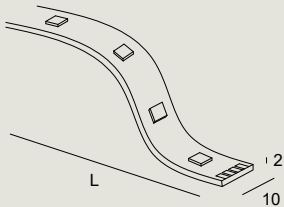

LED							
K	CRI	W/1m	Real Lm/1m	Size (mm)	Min. cutting length (mm.)	Maximum xm.	Code
2700	90	24.4	2606	50000	42	5	91-7940 - 00 - 00L
3000	90	24.4	2606	50000	42	5	91-7941 - 00 - 00L

24VDC

ⓘ P. 942

ON

On Advanced CRI98

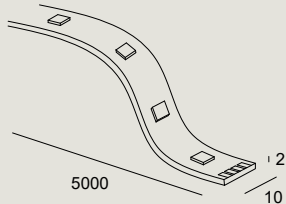

BODY MAT	IP	3		
AL	20	MacAdam	5 m	

00

LED						
K	CRI	W LED	Real Lm	W/1m	Real Lm/1m	Code
2700	98	60	6576	12	1315	91-7942 - 00 - 00
3000	98	84	9432	16.8	1886	91-7943 - 00 - 00

P. 942

ON

On Advanced CRI98 Custom size

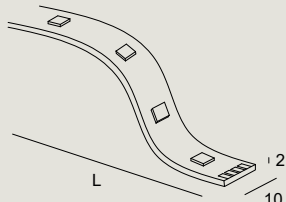

BODY MAT	IP	3			
AL	20	MacAdam	5 m		

00

LED							
K	CRI	W/1m	Real Lm/1m	Size (mm)	Min. cutting length (mm.)	Maximum xm.	Code
2700	98	12	1315	50000	62.5	5	91-7942 - 00 - 00L
3000	98	16.8	1886	50000	62.5	5	91-7943 - 00 - 00L

P. 942

ON

On Advanced 160 Lm/W

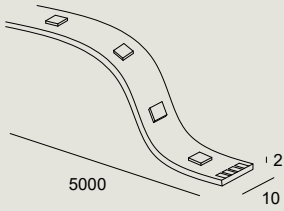

BODY MAT	IP	3	☐ + ☐ + ☐	(SC)
AL	20	MacAdam	7 m	

00 ○

LED						
K	CRI	W LED	Real Lm	W/1m	Real Lm/1m	Code
2700	80	45	7035	9	1407	91-7944 - 00 - 00
3000	80	46	7009	9.2	1402	91-7945 - 00 - 00

24VDC

ⓘ P. 942

ON

On Advanced 160 Lm/W Custom size

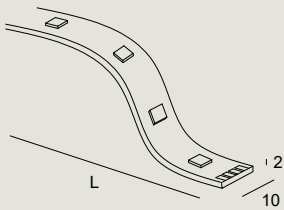

BODY MAT	IP	3	☐ + ☐ + ☐	(SC)	
AL	20	MacAdam	7 m		

00 ○

LED							
K	CRI	W/1m	Real Lm/1m	Size (mm)	Min. cutting length (mm.)	Maximum xm.	Code
2700	80	9	1407	50000	50	7	91-7944 - 00 - 00L
3000	80	9.2	1402	50000	50	7	91-7945 - 00 - 00L

24VDC

ⓘ P. 942

ON

On Advanced Thin 4mm

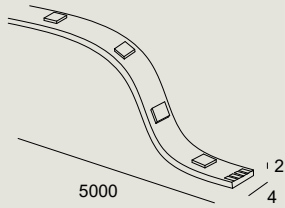

BODY MAT	IP	3	••• + •••	(SC)
AL	20	MacAdam	5 m	

00 ○

LED						
K	CRI	W LED	Real Lm	W/1m	Real Lm/1m	Code
2700	90	46	3090	9.2	618	91-7946 - 00 - 00
3000	90	46	3226	9.2	646	91-7947 - 00 - 00

24VDC

P. 942

ON

On Advanced Thin 4mm Custom size

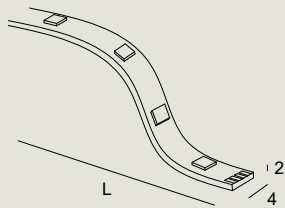

BODY MAT	IP	3	••• + •••	(SC)	✂
AL	20	MacAdam	5 m		

00 ○

LED							
K	CRI	W/1m	Real Lm/1m	Size (mm)	Min. cutting length (mm.)	Maximum xm.	Code
2700	90	9.2	618	20000	50	5	91-7946 - 00 - 00L
3000	90	9.2	646	20000	50	5	91-7947 - 00 - 00L

24VDC

P. 942

ON

On Advanced High Density 240 LED/MT

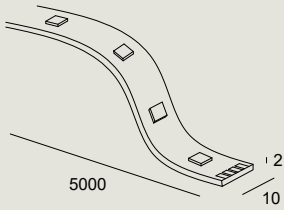

BODY MAT	IP	3	••• + •••	(SC)
AL	20	MacAdam	7 m	

00 ○

LED						
K	CRI	W LED	Real Lm	W/1m	Real Lm/1m	Code
2700	90	70	5062	14	1012	91-7948 - 00 - 00
3000	90	70	5176	14	1035	91-7949 - 00 - 00

24VDC

ⓘ P. 942

ON

On Advanced High Density 240 LED/MT Custom size

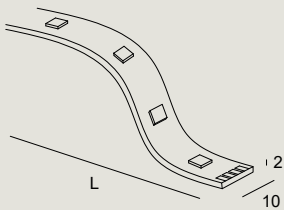

BODY MAT	IP	3	••• + •••	(SC)	✂
AL	20	MacAdam	7 m		

00 ○

LED							
K	CRI	W/1m	Real Lm/1m	Size (mm)	Min. cutting lenght (mm.)	Maximum xm.	Code
2700	90	14	1012	50000	25	7	91-7948 - 00 - 00L
3000	90	14	1035	50000	25	7	91-7949 - 00 - 00L

24VDC

ⓘ P. 942

ON

On Advanced Double LED

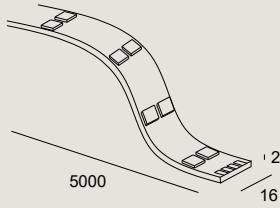

BODY MAT	IP	3	8 m	(SC)
AL	20	MacAdam	8 m	

00 ○

LED						
K	CRI	W LED	Real Lm	W/1m	Real Lm/1m	Code
2700	90	84	6879	16.8	1376	91-7950 - 00 - 00
3000	90	84	6879	16.8	1376	91-7951 - 00 - 00

24VDC

P. 942

ON

On Advanced Double LED Custom size

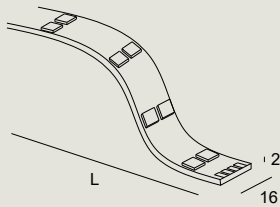

BODY MAT	IP	3	8 m	(SC)	✂
AL	20	MacAdam	8 m		













00 ○

LED							
K	CRI	W/1m	Real Lm/1m	Size (mm)	Min. cutting length (mm.)	Maximum xm.	Code
2700	90	16.8	1376	50000	50	8	91-7950 - 00 - 00L
3000	90	16.8	1376	50000	50	8	91-7951 - 00 - 00L

24VDC

P. 942

OUTDOOR

 <p>Modulare Systeme Sistemi modulari</p> <p>449</p>	 <p>Lineare Beleuchtungssysteme Sistemi lineari d'illuminazione</p> <p>485</p>	 <p>Strahler Proiettori</p> <p>537</p>	 <p>Unterwasserleuchten Lucisommeregibili</p> <p>591</p>	 <p>Deckeneinbauleuchten Incassi a soffitto</p> <p>595</p>
 <p>Wandeinbauleuchten Incassi a parete</p> <p>611</p>	 <p>Bodeneinbauleuchten Incassi a pavimento</p> <p>637</p>	 <p>Uplights für Aufsatzmontage Uplight di superficie</p> <p>681</p>	 <p>Pollerleuchten Faretti</p> <p>691</p>	 <p>Mastleuchten Lampioni</p> <p>741</p>
 <p>Wandleuchten Lampade da parete</p> <p>757</p>	 <p>Deckenleuchten Plafoniere</p> <p>833</p>	 <p>Chillout Chillout</p> <p>859</p>		



Modulare Systeme

Sistemi modulari



Max

451

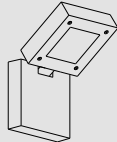

Modis

471



Max

50000h	DIF MAT
L80 B20	GLA



Video ansehen
Guarda il video

Max ist das modulare Sortiment par excellence im Outdoor-Katalog von LEDS C4. Es ist kompakt, widerstandsfähig und elegant und bietet eine Vielzahl von Anwendungsmöglichkeiten für Wand, Boden und Decke sowie verschiedene Optionen dank der großen Auswahl an Filtern, Optiken und LED-Typen (die sich umweltfreundlich austauschen lassen). Neu in der Kollektion sind jetzt leistungsstärkere und größere Modelle, die auch bei umfangreicheren Projekte optimale Lösungen bieten. Besonders hervorzuheben ist die hohe Leistung, wie IK10, IP65, CRI90 und UGR <12. Zudem wird es einer Spezialbehandlung unterzogen, um sogar den Einsatz in Meeresnähe zu ermöglichen. Außerdem können eine Blende zur Verbesserung des Sehkomforts und ein Pflock zur Aufstellung auf dem Rasen angebracht werden.

Max è la collezione più modulare della linea per esterno della LEDS C4. Compatta, resistente ed elegante, dispone di un'ampia gamma di applicazioni per parete, pavimento e soffitto con varie opzioni, grazie alla grande varietà di filtri, ottiche e tipi di LED impiegati (eco-progettati per essere sostituibili). Sono presenti modelli più potenti e più grandi per progetti di maggiore portata. Si contraddistingue per le sue elevate prestazioni come IK10, IP65, CRI90 e un UGR<12. Inoltre, ha un trattamento speciale che la rende adatta a essere installata vicino al mare. Consente anche l'installazione di una visiera per migliorare il comfort visivo e di un picchetto per l'installazione su prato.

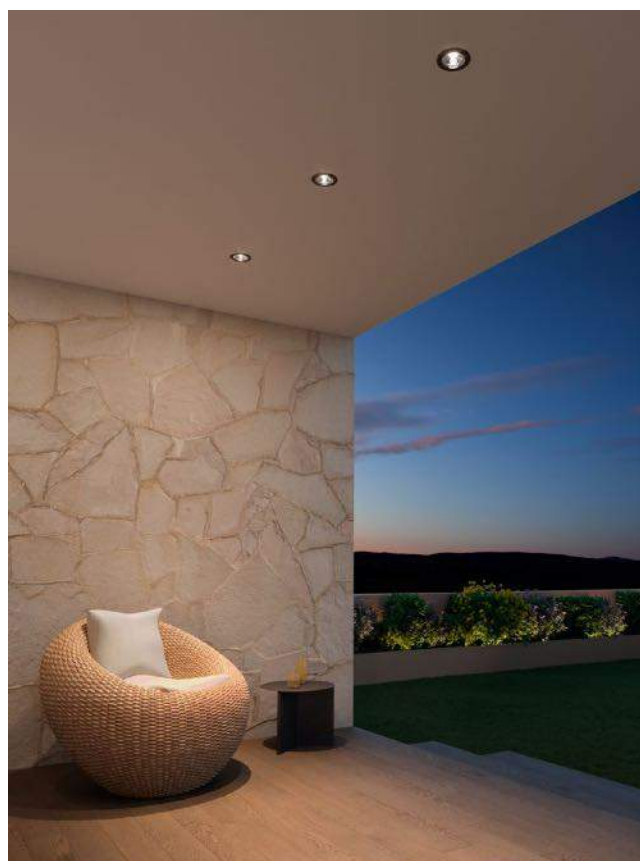

Max

Downlight P. 565

Uplight P. 607

Comfort

Round

Square

Trimless

Round

Square



Ø 100 mm



Ø 75 mm



Ø 75 mm



Ø 58 mm



Ø 75 mm



Ø 75 mm



Ø 140 mm



Ø 110 mm



Ø 110 mm



Ø 83 mm



Ø 110 mm



Ø 110 mm

4 - 17,3 W

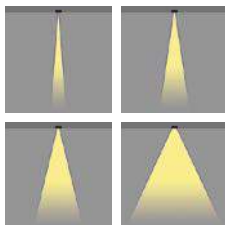

Ultra spot - Ultra flood
8,6° / 17° / 27° / 50°

14 ○ 34 ○ 60 ●

DL ● E3 ● J6 ●

Z5 ●

4 - 17,3 W

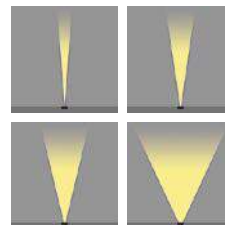

Ultra spot - Ultra flood
8,6° / 17° / 27° / 50°

Z5 ● CA ●

Spotlight

P. 529

Surface



Ø 58 mm



Ø 82 mm

Bollard



Ø 58 mm
H 600 mm



Ø 82 mm
H 800 mm

4 - 17,3 W

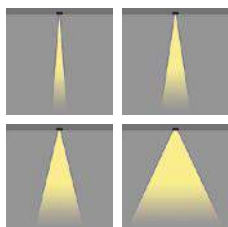

Ultra spot - Ultra flood
8,6° / 17° / 27° / 50°

- 14 ○ 34 ● 60 ●
- DL ● E3 ● J6 ●
- Z5 ●

Wall

P. 759

Single emission



L 85 x W 52 x H 100 mm



L 85 x W 62 x H 204 mm



L 92 x W 113 x H 200 mm

Double emission



L 85 x W 62 x H 135 mm



L 85 x W 62 x H 245 mm



L 92 x W 113 x H 280 mm

4 - 31,5 W

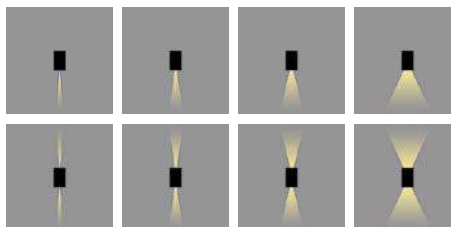

Ultra spot - Ultra flood
8,6° / 17° / 27° / 50°

- 14 ○ 34 ● 60 ●
- DL ● E3 ● J6 ●
- Z5 ●



Ceiling

P. 845

Ceiling



Ø 58 x H 160 mm



Ø 58 x H 251 mm



Ø 83 x H 230 mm

4 - 17,3 W

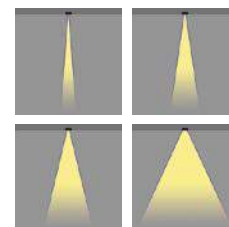

Ultra spot - Ultra flood
8,6° / 17° / 27° / 50°

- 14 ○ 34 ● 60 ●
- DL ● E3 ● J6 ●
- Z5 ●



Kompaktes Design Design compatto

Das neutrale und kompakte Design ermöglicht den Einbau in alle Arten von Innenräumen, was es zu einem jederzeit attraktiven, diskreten und eleganten Produkt macht.

Il suo design neutro e compatto ne favorisce l'installazione in tutti i tipi di interni, rendendolo un pezzo attraente, discreto ed elegante.



Ökodesign Ecodesign

Ökodesign dank austauschbarer LED-Module. Mit einem niedrigen Blendungswert von UGR <12 weist Max einen hohen Sehkomfort auf und bietet mit einer hohen Farbwiedergabe von CRI90.

Il suo design risponde a un parametro ecologico, grazie all'utilizzo di moduli LED sostituibili. Dotato di un elevato comfort visivo contraddistinto da un UGR < 12, Max offre un'elevata resa cromatica con un CRI90.



Winkel und Farbtemperaturen Angoli e temperature

Die Kollektion ist mit vier Ausstrahlwinkeln (ultraspot bis ultraflood) und drei Farbtemperaturen (2700 K, 3000 K und 4000 K) erhältlich.

La collezione viene proposta con 4 angoli di apertura (ultraspot - ultraflood) e 3 temperature di colore (2700K, 3000K e 4000K).

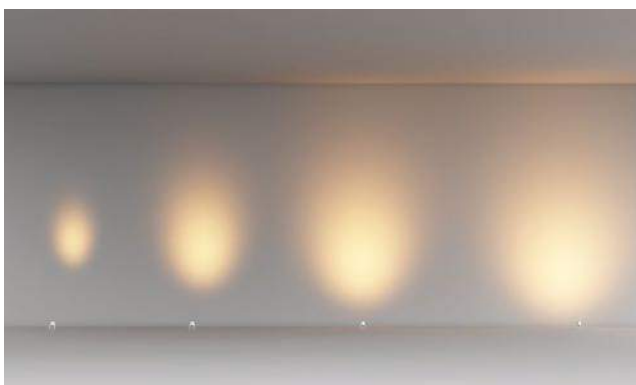

Umfangreiches Zubehör Ampia gamma di accessori

Die Kollektion beinhaltet eine große Auswahl an Zubehör wie einen elliptischen Diffusor, einen quadratischen Diffusor, ein Wabenraster und eine Weichzeichnerlinse.

La collezione dispone di un'ampia gamma di accessori quali diffusore ellittico, diffusore quadrato, pannello a nido d'ape e diffusore dell'alone.

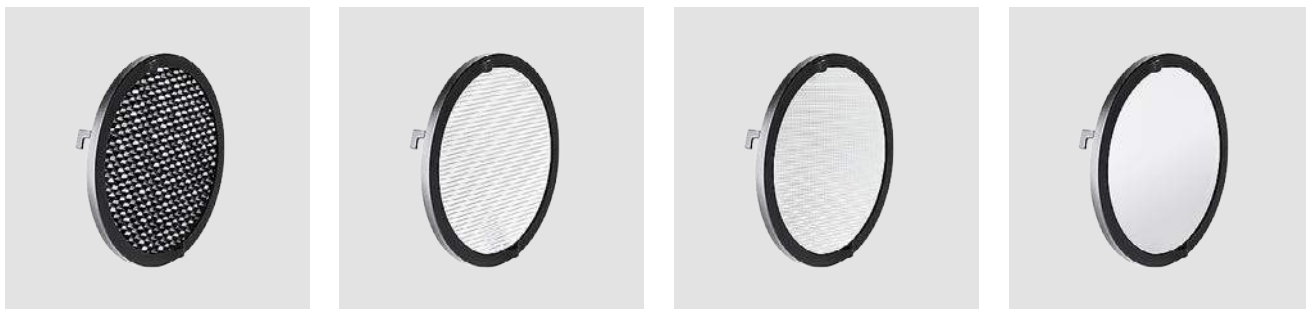

Perfekte Abdichtung Perfetta tenuta stagna

Außerdem sind ein externes Kabel und spezielle Stopfbuchsenabdichtung inbegriffen, um die Dichtigkeit und Zuverlässigkeit der Leuchte zu garantieren.

Include un cavo esterno e premistoppa speciale antiapertura, che garantiscono la tenuta e l'affidabilità dell'apparecchio.



Farbausführungen The Colours Finiture The Colours

Max ist als Strahler, Deckeneinbau-, Wand- und Deckenleuchte in allen The Colours-Farbtönen des LEDS C4-Katalogs erhältlich und als Zubehör mit Blende lieferbar.

Max proiettore, faretto da soffitto, applique e lampadario è disponibile in tutte le finiture The Colours del catalogo LEDS C4, come anche l'accessorio opzionale visiera.



Smart

Die neuen Wandleuchten und die Deckenleuchten-Version beinhalten ein Bluetooth-Modul mit Casambi-Technologie, das eine große Auswahl an Funktionen in Verbindung mit einer traditionellen, 3-adrigen Installation ermöglichen.

Le nuove applique e la versione a soffitto integrano un dispositivo Bluetooth con tecnologia Casambi, unendo una grande varietà di funzionalità connettive con la possibilità di eseguire un'installazione tradizionale di Fase, Neutro e Terra.



Smart-Funktionen: vorbeugende Wartung Funzionalità Smart: Manutenzione preventiva

Ein Smart-Connectivity-System ermöglicht unter anderem die genaue Kenntnis des Zustands der Leuchten zu jeder Zeit, was eine Anpassung der Wartungsstrategien der Leuchten auf der Grundlage von Informationen wie der Anzahl der Betriebsstunden ermöglicht. Auf diese Weise werden Ausfälle und Alarmmeldungen verhindert und die Sicherheit der Menschen durch Vermeidung von Dunkelbereichen gewährleistet.

Una delle funzionalità consentite da un sistema di connettività Smart consiste nella conoscenza precisa dello stato degli apparecchi in ogni momento. Si permette, quindi, di adattare le strategie di manutenzione degli apparecchi in base a informazioni come il numero di ore di accensione. In questo modo, si prevencono guasti ed allarmi mantenendo la sicurezza delle persone evitando zone buie.

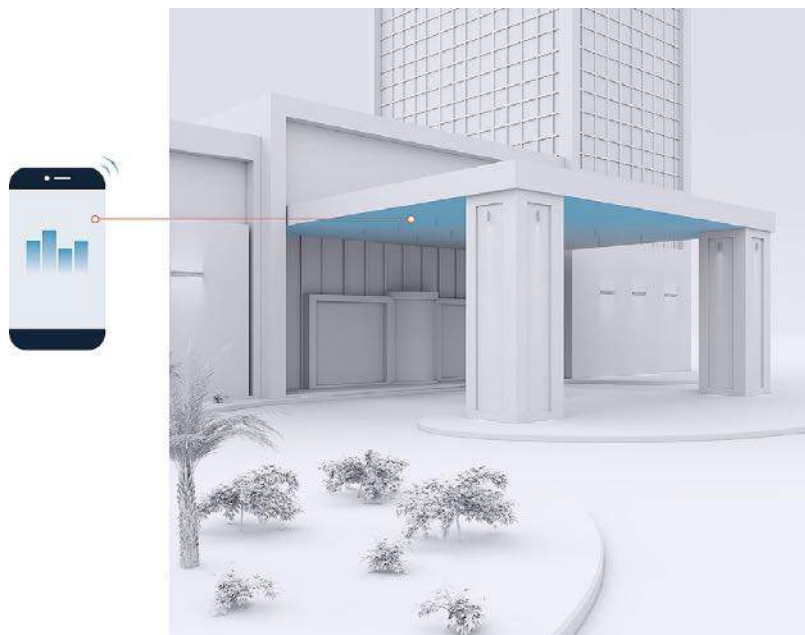













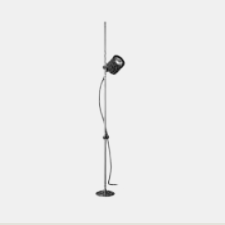
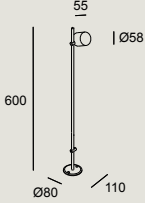

MAX

Max Spotlight



Codebeispiel / Esempio di codice: AI18-P4V9S1BBZ5

Model	W	K/ Cri/ Real lm	Optics	Source	Finishes
AI18 - Ohne halterung / Senza asta  	P4 4W	V9 2700K CRI90/286 lm	S1 9°	BB  12V Max. 350mA	Z5  14*  60*  34* 
		W9 3000K CRI90/286 lm			
		X9 4000K CRI90/286 lm			
AI17 - Mit Halterung / Con asta  	P7 6,5W	V9 2700K CRI90/519 lm	S2 17°	BB  18V Max. 350mA	J6*  E3*  DL* 
		W9 3000K CRI90/519 lm			
		X9 4000K CRI90/519 lm			

AI11 AI12 AI13 AI14 AI15 AI16 AI17 AI18	IP 	u. min	u. max				Code
			P4 (8,6°)		P7 (17°/ 27°/ 50°)		
			220-240V	110-127V	220-240V	110-127V	
	ON-OFF	1	4	3	2	2	71-E079-00-00
	DALI	1	4	4	2	2	71-E083-00-00
	0-10V	1	4	4	2	2	71-E083-00-00
	ON-OFF	1	6	6	4	4	71-3542-00-00
	DALI	1	6	6	4	4	71-4706-00-00
	0-10V	1	6	6	4	4	71-4706-00-00
Optional IP66 IK09 box (300x200x105mm)							71-E100-00-00

ⓘ P. 946

nicht inklusive / Non incluso	
IP68-Stecker mit 6 Eingängen / Connettore IP68 a 6 ingressi	71-9199-05-05
IP67-Stecker mit 3 Eingängen / Connettore IP67 a 3 ingressi	71-9262-05-05
IP68- Antikondensationsstecker mit 2 Eingängen / Connettore IP68 con valvola anticondensa a 2 ingressi	71-E112-00-00
5 Wabenraster / 5 pannelli a nido d'ape	71-E131-00-00
5 Lichtfilter für gestreute Lichtkegel / 5 filtri per l'emissione di luce diffusa	71-E133-00-00
5 Lichtfilter für quadratische Lichtkegel / 5 filtri per l'emissione di luce quadrata	71-E135-00-00
5 Lichtfilter für elliptische Lichtkegel / 5 filtri per emettere luce ellittica	71-E141-00-00
Erdbefestigungsspieß / Picchetto di fissaggio a terra (AI18)	71-E143-05-05
Blende weiß / Visiera bianca	71-E145-14-14
Blende hellgrau / Visiera grigio chiaro	71-E145-34-34
Blende schwarz / Visiera nera	71-E145-60-60
Blende gold / Visiera dorata	71-E145-DL-DL
Blende tannengrün / Visiera verde abete	71-E145-E3-E3
Blende braun / Visiera marrone	71-E145-J6-J6
Blende grau / Visiera grigia	71-E145-Z5-Z5

*Fragen Sie unser Verkaufsteam nach den Lieferbedingungen.











Consultare i termini e le condizioni di consegna al nostro team commerciale.

MAX

Max Spotlight

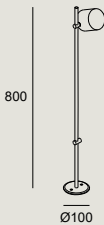

Codebeispiel / Esempio di codice: AT18-18V9S3BBZ5

Model	W	K/ Cri/ Real lm	Optics	Source	Finishes
AT18 - Ohne halterung / Senza asta  	18 17,3W	V9 2700K CRI90/1902 lm	S3 21°	BB  36V Max.500mA	Z5  14*  60*  34*  J6*  E3*  DL* 
		W9 3000K CRI90/2047 lm	M3 31°		
		X9 4000K CRI90/2191 lm	F1 40°		
AT17 - Mit Halterung / Con asta  					

	IP		u. min			u. max			Code
			220-240V	110-127V					
AT11									
AT12									
AT13									
AT14		ON-OFF	1	1	1			71-E068-00-00	
AT15	IP68	DALI	1	1	1			71-E085-00-00	
AT16		0-10V	1	1	1			71-E085-00-00	
AT17		ON-OFF	1	2	2			71-3542-00-00	
AT18	IP20	DALI	1	2	2			71-4706-00-00	
		0-10V	1	2	2			71-4706-00-00	
	Optional IP66 IK09 box (300x200x105mm)								71-E100-00-00

① P. 946

nicht inklusive / Non incluso	
IP68-Stecker mit 6 Eingängen / Connettore IP68 a 6 ingressi	71-9199-05-05
IP67-Stecker mit 3 Eingängen / Connettore IP67 a 3 ingressi	71-9262-05-05
Pflock 235 mm / Paletto 235mm (AT18)	71-9997-05-05
Pflock 302mm / Paletto 302mm (AT18)	71-9998-05-05
IP68- Antikondensationsstecker mit 2 Eingängen / Connettore IP68 con valvola anticondensa a 2 ingressi	71-E112-00-00
5 Wabenraster / 5 pannelli a nido d'ape	71-E263-00-00
5 Lichtfilter für gestreute Lichtkegel / 5 filtri per l'emissione di luce diffusa	71-E260-00-00
5 Lichtfilter für quadratische Lichtkegel / 5 filtri per l'emissione di luce quadrata	71-E262-00-00
5 Lichtfilter für elliptische Lichtkegel / 5 filtri per emettere luce ellittica	71-E261-00-00
Blende weiß / Visiera bianca	71-E259-14-00
Blende hellgrau / Visiera grigio chiaro	71-E259-34-00
Blende schwarz / Visiera nera	71-E259-60-00
Blende gold / Visiera dorata	71-E259-DL-00
Blende tannengrün / Visiera verde abete	71-E259-E3-00
Blende braun / Visiera marrone	71-E259-J6-00
Blende grau / Visiera grigia	71-E259-Z5-00

*Fragen Sie unser Verkaufsteam nach den Lieferbedingungen.

Consultare i termini e le condizioni di consegna al nostro team commerciale.

MAX

Max Downlight

BODY MAT
AL













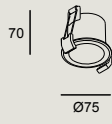



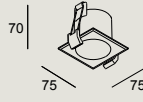

IK
10

1 m

SEASIDE
SUITABLE

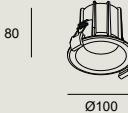
IP
66

Codebeispiel / Esempio di codice: AI14-P4V9S1BBZ5

Model	W	K/ Cri/ Real lm	Optics	Source	Finishes
AI14 - Rund / Mit rahmen Rotondo / Con cornice Ø 65  	P4 4W	V9 2700K CRI90/286 lm	S1 9°	BB  12V Max. 350mA	Z5 
		W9 3000K CRI90/286 lm			14* 
		X9 4000K CRI90/286 lm			60* 
AI15 - Quadratisch / Mit rahmen Quadrato / Con cornice Ø 65  	P7 6,5W	V9 2700K CRI90/519 lm	S2 17°	BB  18V Max. 350mA	J6* 
		W9 3000K CRI90/519 lm	M2 27°		E3* 
		X9 4000K CRI90/519 lm	F1 50°		DL* 
AI16 - Rund / zurückversetzt / mit Rahmen Rotondo / retrocesso / con cornice Ø 85  	P4 4W	V9 2700K CRI90/286 lm	S1 9°	BB  12V Max. 350mA	Z5 
		W9 3000K CRI90/286 lm			14* 

	IP		u. min		u. max		Code	
			P4 (8,6°)	P7 (17°/ 27°/ 50°)	P4 (8,6°)	P7 (17°/ 27°/ 50°)		
AI11								
AI12								
AI13								
AI14								
AI15		ON-OFF	1	4	3	2	2	71-E079-00-00
AI16	IP68	DALI	1	4	4	2	2	71-E083-00-00
AI17		0-10V	1	4	4	2	2	71-E083-00-00
AI18		ON-OFF	1	6	6	4	4	71-3542-00-00
	IP20	DALI	1	6	6	4	4	71-4706-00-00
		0-10V	1	6	6	4	4	71-4706-00-00
Optional IP66 IK09 box (300x200x105mm)								71-E100-00-00

ⓘ P. 946

nicht inklusive / Non incluso	
IP68-Stecker mit 6 Eingängen / Connettore IP68 a 6 ingressi	71-9199-05-05
IP67-Stecker mit 3 Eingängen / Connettore IP67 a 3 ingressi	71-9262-05-05
Unterputzdose / Scatola da incasso (AI16)	71-E354-00-00
Unterputzdose / Scatola da incasso (AI14, AI15)	71-E035-00-00
IP68- Antikondensationsstecker mit 2 Eingängen Connettore IP68 con valvola anticondensa a 2 ingressi	71-E112-00-00
5 Wabenraster / 5 pannelli a nido d'ape	71-E131-00-00
5 Lichtfilter für gestreute Lichtkegel / 5 filtri per l'emissione di luce diffusa	71-E133-00-00
5 Lichtfilter für quadratische Lichtkegel / 5 filtri per l'emissione di luce quadrata	71-E135-00-00
5 Lichtfilter für elliptische Lichtkegel / 5 filtri per emettere luce ellittica	71-E141-00-00

*Fragen Sie unser Verkaufsteam nach den Lieferbedingungen.











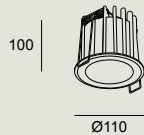

Consultare i termini e le condizioni di consegna al nostro team commerciale.

MAX

Max Downlight

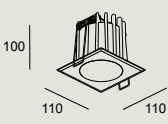

Codebeispiel / Esempio di codice: AT14-18V9S3BBZ5

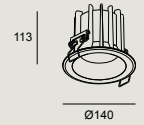
Model	W	K/ Cri/ Real lm	Optics	Source	Finishes
AT14 - Rund / Mit rahmen Rotondo / Con cornice Ø 65 0-70 mm  	18 17,3W	V9 2700K CRI90/1902 lm	S3 21°	BB  36V Max.500mA	Z5  14*  60*  34*  J6*  E3*  DL* 
		W9 3000K CRI90/2047 lm	M3 31°		
		X9 4000K CRI90/2191 lm	F1 40°		
AT15 - Quadratisch / Mit rahmen Quadrato / Con cornice Ø 65 0-70 mm  					
AT16 - Rund / zurückversetzt / mit Rahmen Rotondo / retrocesso / con cornice Ø 85 0-25 mm  					

	IP		u. max		Code
			u. min	220-240V 110-127V	
AT11					
AT12					
AT13					
AT14		ON-OFF	1	1	71-E068-00-00
AT15	IP68	DALI	1	1	71-E085-00-00
AT16		0-10V	1	1	71-E085-00-00
AT17		ON-OFF	1	2	71-3542-00-00
AT18	IP20	DALI	1	2	71-4706-00-00
		0-10V	1	2	71-4706-00-00
		Optional IP66 IK09 box (300x200x105mm)			71-E100-00-00

① P. 946

nicht inklusive / Non incluso	
IP68-Stecker mit 6 Eingängen / Connettore IP68 a 6 ingressi	71-9199-05-05
IP67-Stecker mit 3 Eingängen / Connettore IP67 a 3 ingressi	71-9262-05-05
IP68- Antikondensationsstecker mit 2 Eingängen Connettore IP68 con valvola anticondensa a 2 ingressi	71-E112-00-00
5 Lichtfilter für gestreute Lichtkegel / 5 filtri per l'emissione di luce diffusa	71-E260-00-00
5 Lichtfilter für elliptische Lichtkegel / 5 filtri per emettere luce ellittica	71-E261-00-00
5 Lichtfilter für quadratische Lichtkegel / 5 filtri per l'emissione di luce quadrata	71-E262-00-00
5 Wabenraster / 5 pannelli a nido d'ape	71-E263-00-00
Unterputzdose / Scatola da incasso (AT14, AT15)	71-E355-00-00
Unterputzdose / Scatola da incasso (AT16)	71-E356-00-00

*Fragen Sie unser Verkaufsteam nach den Lieferbedingungen.

Consultare i termini e le condizioni di consegna al nostro team commerciale.

MAX

Max Uplight



IP
66

IK
10











1 m

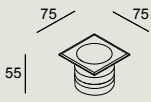

SEA SIDE SUITABLE

BREEAM

Codebeispiel / Esempio di codice: AI11-P4V9S1BBCA

Model	W	K/ Cri/ Real lm	Optics	Source	Finishes
AI11 - Quadratisch / Mit rahmen Quadrato / Con cornice Ⓢ 60  	P4 4W	V9 2700K CRI90/286 lm	S1 9°	BB  12V Max. 350mA	CA  Only for AI11/AI12 Z5  Only for AI13
		W9 3000K CRI90/286 lm			
		X9 4000K CRI90/286 lm			
AI12 - Rund / Mit rahmen Rotondo / Con cornice Ⓢ 60  	P7 6.5W	V9 2700K CRI90/519 lm	S2 17°	BB  18V Max. 350mA	
		W9 3000K CRI90/519 lm			
		X9 4000K CRI90/519lm			
AI13 - Rund / Mit rahmen Rotondo / Con cornice  					

	u. max							
	IP		u. min	P4 (8,6°)		P7 (17°/ 27°/ 50°)		Code
				220-240V	110-127V	220-240V	110-127V	
AI11		ON-OFF	1	4	3	2	2	71-E079-00-00
AI12								
AI13								
AI14	IP68	DALI	1	4	4	2	2	71-E083-00-00
AI15								
AI16		0-10V	1	4	4	2	2	71-E083-00-00
AI17								
AI18		ON-OFF	1	6	6	4	4	71-3542-00-00
	IP20	DALI	1	6	6	4	4	71-4706-00-00
		0-10V	1	6	6	4	4	71-4706-00-00
	Optional IP66 IK09 box (300x200x105mm)							71-E100-00-00

ⓘ P. 946

inklusive / Incluso
Unterputzdose / Cassetta da incasso (AI13) Saugnapf zum Herausnehmen von LED-Modulen / Ventosa di estrazione moduli LED





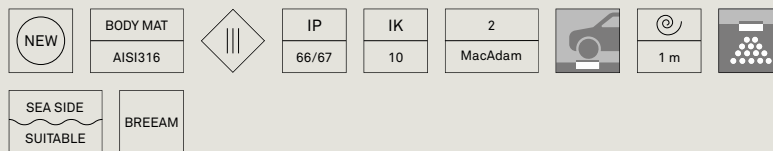

nicht inklusive / Non incluso	
IP68-Stecker mit 6 Eingängen / Connettore IP68 a 6 ingressi	71-9199-05-05
IP67-Stecker mit 3 Eingängen / Connettore IP67 a 3 ingressi	71-9262-05-05
IP68- Antikondensationsstecker mit 2 Eingängen Connettore IP68 con valvola anticondensa a 2 ingressi	71-E112-00-00
5 Wabenraster / 5 pannelli a nido d'ape	71-E131-00-00
5 Lichtfilter für gestreute Lichtkegel / 5 filtri per l'emissione di luce diffusa	71-E133-00-00
5 Lichtfilter für quadratische Lichtkegel / 5 filtri per l'emissione di luce quadrata	71-E135-00-00
Unterputzdose / Scatola da incasso (AI11, AI12)	71-E139-00-00
5 Lichtfilter für elliptische Lichtkegel / 5 filtri per emettere luce ellittica	71-E141-00-00

MAX

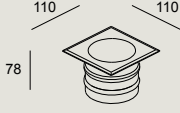
Max Uplight

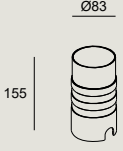

Codebeispiel / Esempio di codice: AT11-18V9S3BBCA

Model	W	K/ Cri/ Real lm	Optics	Source	Finishes
AT11 - Quadratisch / Mit rahmen Quadrato / Con cornice  	18 17,3W	V9 2700K CRI90/1902 lm	S3 21°	BB  36V Max.500mA	CA 
		W9 3000K CRI90/2047 lm	M3 31°		
		X9 4000K CRI90/2191 lm	F1 40°		
AT12 - Rund / Mit rahmen Rotondo / Con cornice  					
AT13 - Rund / Ohne rahmen Rotondo / Senza cornice  					

	IP		u. min		u. max		Code
			220-240V	110-127V	220-240V	110-127V	
AT11							
AT12							
AT13							
AT14		ON-OFF	1	1	1	71-E068-00-00	
AT15	IP68	DALI	1	1	1	71-E085-00-00	
AT16		0-10V	1	1	1	71-E085-00-00	
AT17		ON-OFF	1	2	2	71-3542-00-00	
AT18	IP20	DALI	1	2	2	71-4706-00-00	
		0-10V	1	2	2	71-4706-00-00	
		Optional IP66 IK09 box (300x200x105mm)				71-E100-00-00	

① P. 946

inklusive / Incluso
Unterputzdose / Cassetta da incasso (AT13)
Saugnapf zum Herausnehmen von LED-Modulen / Ventosa di estrazione moduli LED



nicht inklusive / Non incluso	
IP68-Stecker mit 6 Eingängen / Connettore IP68 a 6 ingressi	71-9199-05-05
IP67-Stecker mit 3 Eingängen / Connettore IP67 a 3 ingressi	71-9262-05-05
IP68- Antikondensationsstecker mit 2 Eingängen Connettore IP68 con valvola anticondensa a 2 ingressi	71-E112-00-00
5 Lichtfilter für gestreute Lichtkegel / 5 filtri per l'emissione di luce diffusa	71-E260-00-00
5 Lichtfilter für elliptische Lichtkegel / 5 filtri per emettere luce ellittica	71-E261-00-00
5 Lichtfilter für quadratische Lichtkegel / 5 filtri per l'emissione di luce quadrata	71-E262-00-00
5 Wabenraster / 5 pannelli a nido d'ape	71-E263-00-00
Unterputzdose / Scatola da incasso (AT11, AT12)	71-E264-00-00

MAX

Max Wall Fixture Single emission



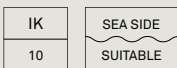

Codebeispiel / Esempio di codice: AI19-P4V9S10SZ5

Model	W	K/ Cri/ Real lm	Optics	Source	Finishes
AI19 - Unifirektional Mono emissione  	P4 4W	V9 2700K CRI90/286 lm	S1 9°	OS ON-OFF 220-240V 50-60Hz	Z5
		W9 3000K CRI90/286 lm			14*
		X9 4000K CRI90/286 lm			60*
	P7 6,5W	V9 2700K CRI90/519 lm	S2 17°	OS ON-OFF 220-240V 50-60Hz	34*
		W9 3000K CRI90/519 lm	M2 27°		J6*
		X9 4000K CRI90/519 lm	F1 50°		E3*
					DL*



Codebeispiel / Esempio di codice: AI23-P6V9S1DUZ5

Model	W	K/ Cri/ Real lm	Optics	Source	Finishes	
AI23 - Unidirektional Mono emissione  	P6 6W	V9 2700K CRI90/373 lm	S1 9°	DU DALI-2 100-277V 50-60Hz	Z5	
		W9 3000K CRI90/373 lm			XB CASAMBI 220-240V 50-60Hz	14*
		X9 4000K CRI90/373 lm				60*
	P8 8,9W	V9 2700K CRI90/610 lm	S2 17°	DU DALI-2 100-277V 50-60Hz	34*	
		W9 3000K CRI90/610 lm	M2 27°		XB CASAMBI 220-240V 50-60Hz	J6*
		X9 4000K CRI90/610 lm	F1 50°			E3*
					DL*	

nicht mitgeliefertes allgemeines Zub.
Access. comuni non inclusi

5 Wabenraster
5 pannelli a nido d'ape

71-E131-00-00

5 Lichtfilter für gestreute Lichtkegel
5 filtri per l'emissione di luce diffusa

71-E133-00-00

5 Lichtfilter für quadratische Lichtkegel
5 filtri per l'emissione di luce quadrata

71-E135-00-00

5 Lichtfilter für elliptische Lichtkegel
5 filtri per emettere luce ellittica

71-E141-00-00

*Fragen Sie unser Verkaufsteam nach den Lieferbedingungen.

Consultare i termini e le condizioni di consegna al nostro team commerciale.

MAX**Max Wall Fixture
Single emission**

Codebeispiel / Esempio di codice: AT19-18V9S3OSZ5

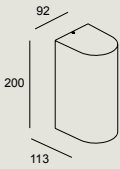
Model	W	K/ Cri/ Real lm	Optics	Source	Finishes
AT19 - Unidirektional Mono emissione  	18 17,3W	V9 2700K CRI90 1902 lm	S3 21°	OS ON-OFF 220-240V 50-60Hz	Z5
		W9 3000K CRI90 2047 lm	M3 31°	DU DALI-2 100-277V 50-60Hz	14*
		X9 4000K CRI90 2191 lm	F1 40°	XB CASAMBI 220-240V 50-60Hz	60*
					34*
					J6*
					E3*
					DL*

**nicht inklusive / Non incluso**

5 Lichtfilter für gestreute Lichtkegel/ 5 filtri per l'emissione di luce diffusa	71-E260-00-00
5 Lichtfilter für elliptische Lichtkegel / 5 filtri per emettere luce ellittica	71-E261-00-00
5 Lichtfilter für quadratische Lichtkegel / 5 filtri per l'emissione di luce quadrata	71-E262-00-00
5 Wabenraster / 5 pannelli a nido d'ape	71-E263-00-00

*Fragen Sie unser Verkaufsteam nach den Lieferbedingungen.



Consultare i termini e le condizioni di consegna al nostro team commerciale.

MAX

Max Wall Fixture Double Emission



Codebeispiel / Esempio di codice: AI21-P8V9S10SZ5

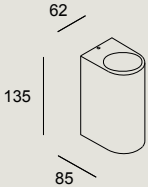

Model	W	K/ Cri/ Real lm	Optics	Source	Finishes
AI21 - Bidirektional Doppia emissione   	P8 8W	V9 2700K CRI90/572 lm	S1 9°	OS ON-OFF 220-240V 50-60Hz	Z5
		W9 3000K CRI90/572 lm			14*
		X9 4000K CRI90/572 lm			60*
	11 10,5W	V9 2700K CRI90/805 lm	S7 8,6° + 17°	OS ON-OFF 220-240V 50-60Hz	34*
		W9 3000K CRI90/805 lm	S8 8,6° + 27°		J6*
		X9 4000K CRI90/805 lm	S9 8,6° + 50°		E3*
	13 13W	V9 2700K CRI90 1038 lm	S2 17° + 17°	OS ON-OFF 220-240V 50-60Hz	DL*
			M2 27° + 27°		
		W9 3000K CRI90 1038 lm	F1 50° + 50°		
M5 27° + 50°					
X9 4000K CRI90 1038 lm		S5 17° + 27°			
		S6 17° + 50°			

MAX

Max Wall Fixture Double Emission

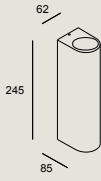

Codebeispiel / Esempio di codice: AI24-12V9S1DUZ5

Model	W	K/ Cri/ Real lm	Optics	Source	Finishes	
AI24 - Bidirektional Doppia emissione   	12 12W	V9 2700K CRI90/747 lm	S1 9°	DU DALI-2/100-277V 50-60Hz	Z5	
		W9 3000K CRI90/747 lm			XB CASAMBI 220-240V 50-60Hz	14*
		X9 4000K CRI90/747 lm			60*	
	14 14,1W	V9 2700K CRI90/957 lm	S7 8,6° + 17°	DU DALI-2/100-277V 50-60Hz	34*	
		W9 3000K CRI90/957 lm	S8 8,6° + 27°		J6*	
		X9 4000K CRI90/957 lm	S9 8,6° + 50°		E3*	
	17 17,8W	V9 2700K CRI90/1221 lm	S2 17° + 17°	DU DALI-2 100-277V 50-60Hz	DL*	
			M2 27° + 27°			
		W9 3000K CRI90/1221 lm	F1 50° + 50°			
M5 27° + 50°						
X9 4000K CRI90/1221 lm		S5 17° + 27°				
		S6 17° + 50°				

nicht mitgeliefert
Access. comuni non inclusi

5 Wabenraster
5 pannelli a nido d'ape

71-E131-00-00

5 Lichtfilter für gestreute Lichtkegel
5 filtri per l'emissione di luce diffusa

71-E133-00-00

5 Lichtfilter für quadratische Lichtkegel
5 filtri per l'emissione di luce quadrata

71-E135-00-00

5 Lichtfilter für elliptische Lichtkegel
5 filtri per emettere luce ellittica

71-E141-00-00

MAX**Max Wall Fixture
Double emission**

Codebeispiel / Esempio di codice: AT21-33V9S3OSZ5

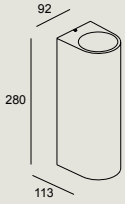
Model	W	K/ Cri/ Real lm	Optics	Source	Finishes
AT21 - Bidirektional Doppia emissione  	33 31,5W	V9 2700K CRI90 3804 lm	S3 21° + 21°	OS ON-OFF 220-240V 50-60Hz	Z5
		W9 3000K CRI90 4094 lm	M3 31° + 31°	DU DALI-2 100-277V 50-60Hz	14*
		X9 4000K CRI90 4382 lm	F1 40° + 40°	XB CASAMBI 220-240V 50-60Hz	60*
			M5 31° + 40°		34*
			S5 21° + 31°		J6*
			S6 21° + 40°		E3*
				DL*	

**nicht inklusive / Non incluso**

5 Lichtfilter für gestreute Lichtkegel / 5 filtri per l'emissione di luce diffusa	71-E260-00-00
5 Lichtfilter für elliptische Lichtkegel / 5 filtri per emettere luce ellittica	71-E261-00-00
5 Lichtfilter für quadratische Lichtkegel / 5 filtri per l'emissione di luce quadrata	71-E262-00-00
5 Wabenraster / 5 pannelli a nido d'ape	71-E263-00-00

*Fragen Sie unser Verkaufsteam nach den Lieferbedingungen.

Consultare i termini e le condizioni di consegna al nostro team commerciale.

MAX

Max Ceiling

BODY MAT
AL



IK
10

SEA SIDE
SUITABLE

IP
66

ON-OFF

Codebeispiel / Esempio di codice: AI22-P3V9S10SZ5

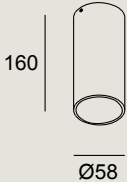
Model	W	K/ Cri/ Real lm	Optics	Source	Finishes
AI22 - Rund / Rotondo  	P3 3,4W	V9 2700K CRI90 257 lm	S1 9°	OS ON-OFF 220-240V 50-60Hz	Z5
		W9 3000K CRI90/286 lm			14*
		X9 4000K CRI90/286 lm			60*
	P6 5,3W	V9 2700K CRI90/519 lm	S2 17°	OS ON-OFF 220-240V 50-60Hz	34*
		W9 3000K CRI90/519 lm			J6*
		X9 4000K CRI90/519 lm			E3*
			F1 50°		DL*

BODY MAT
AL



IK
10

SEA SIDE
SUITABLE

IP
66

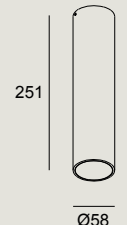

Codebeispiel / Esempio di codice: AI25-P6V9S1DUZ5

Model	W	K/ Cri/ Real lm	Optics	Source	Finishes	
AI25 - Rund / Rotondo  	P6 6W	V9 2700K CRI90/373 lm	S1 9°	DU DALI-2 100-277V 50-60Hz	Z5	
		W9 3000K CRI90/373 lm		XB CASAMBI 220-240V 50-60Hz	14*	
		X9 4000K CRI90/373 lm			60*	
	P8 8,9W	V9 2700K CRI90/610 lm	S2 17°	DU DALI-2 100-277V 50-60Hz	34*	
		W9 3000K CRI90/610 lm			J6*	
		X9 4000K CRI90/610 lm			E3*	
				F1 50°		DL*

nicht mitgeliefertes allgemeines Zub.
Access. comuni non inclusi

5 Wabenraster
5 pannelli a nido d'ape

71-E131-00-00

5 Lichtfilter für gestreute Lichtkegel
5 filtri per l'emissione di luce diffusa

71-E133-00-00

5 Lichtfilter für quadratische Lichtkegel
5 filtri per l'emissione di luce quadrata

71-E135-00-00

5 Lichtfilter für elliptische Lichtkegel
5 filtri per emettere luce ellittica

71-E141-00-00

*Fragen Sie unser Verkaufsteam nach den Lieferbedingungen.

Consultare i termini e le condizioni di consegna al nostro team commerciale.

MAX

Max Ceiling

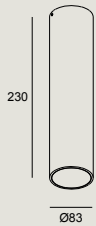

Codebeispiel / Esempio di codice: AT22-18V9S30SZ5

Model	W	K/ Cri/ Real lm	Optics	Source	Finishes
AT22 - Rund / Rotondo  	18 17,3W	V9 2700K CRI90/1902 lm	S3 21°	OS ON-OFF 220-240V 50-60Hz	Z5
		W9 3000K CRI90/2047 lm	M3 31°	DU DALI-2 100-277V 50-60Hz	14*
		X9 4000K CRI90/2191 lm	F1 40°	XB CASAMBI 220-240V/50- 60Hz	60*
					34*
					J6*
					E3*
					DL*

nicht inklusive / Non incluso	
5 Lichtfilter für gestreute Lichtkegel/ 5 filtri per l'emissione di luce diffusa	71-E260-00-00
5 Lichtfilter für elliptische Lichtkegel / 5 filtri per emettere luce ellittica	71-E261-00-00
5 Lichtfilter für quadratische Lichtkegel / 5 filtri per l'emissione di luce quadrata	71-E262-00-00
5 Wabenraster / 5 pannelli a nido d'ape	71-E263-00-00

*Fragen Sie unser Verkaufsteam nach den Lieferbedingungen.
 Consultare i termini e le condizioni di consegna al nostro team commerciale.



Modis

LUCA TURRINI 2022

BODY MAT	DIF MAT		50000h	3
AL	GLA		L80 B20	MacAdam

Modis ist ein neuer Vorschlag für den Außenbereich mit einer ausgeprägt dekorativen Komponente. Ein klares und neutrales Profil sowie eine Konstruktion, die eine hohe Beweglichkeit des Kugelgelenks erlaubt und die Möglichkeit bietet, die Abstrahlungsart zu wählen, denn die Leuchte ist wahlweise mit konzentriertem oder gebündeltem Licht erhältlich. Die vielköpfige Familie der Kollektion und ihre Kompositionsmöglichkeiten machen sie zu einer Lösung, die sich durch ihre Vielseitigkeit auszeichnet und sich meisterhaft und elegant an die Anforderungen von Projekten anpasst, die ein ästhetisches Gleichgewicht im Gesamtbild erfordern. Neben den dekorativen Vorzügen wurde auch den technischen Aspekten große Aufmerksamkeit gewidmet, um die Vielseitigkeit der Familie noch stärker zu betonen. Modis weist eine hohe Stoßfestigkeit (IK10), Staubbichtheit und Hochdruckwasserbeständigkeit (IP66) auf und kann dank der KTL-Grundierung auch in Umgebungen mit harter Seeluft aufgestellt werden.

Modis è una nuova proposta da esterno con una grande componente decorativa. Dal profilo pulito e neutro, il suo design si basa sulla grande capacità di movimento dello snodo e sulla possibilità di scegliere il fascio di luce, con opzione luce concentrata o diffusa. La grande famiglia della collezione e le sue possibilità compositive la trasformano in una scelta caratterizzata da versatilità e adattabile con maestria ed eleganza alle esigenze di progetti che richiedono insieme esteticamente equilibrati. Oltre al valore decorativo, gli aspetti tecnici sono stati curati fin nei minimi dettagli, per offrire una linea ancora più polivalente. Modis ha una grandissima resistenza agli urti (IK10), un'eccellente protezione dall'ingresso di polvere e acqua ad alta pressione (IP66) e può essere installata in ambienti con atmosfera marina, grazie al processo di verniciatura in catforesi.



Spotlight

P. 567



140 x 140 mm



428 x 140 mm



800 x 140 mm

Wall Fixture

P. 807



140 x 140 mm



428 x 140 mm



800 x 140 mm

Ceiling

P. 835

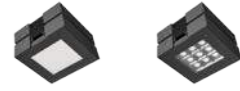

140 x 140 mm



428 x 140 mm



800 x 140 mm

Opal
13,2 - 26,4 W



General light

Optics
21 - 42 W

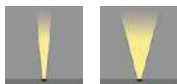

Spot / Flood
Ultra Flood
18° / 34° / 48°

14 ○ 34 ● 60 ● DL ●
E3 ● J6 ● Z5 ●



Opal
13,2 - 26,4 W



General light

Optics
21 - 42 W



Spot / Flood
Ultra Flood
18° / 34° / 48°

14 ○ 34 ● 60 ● DL ●
E3 ● J6 ● Z5 ●



Opal
13,2 - 26,4 W



General light

Optics
21 - 42 W



Spot / Flood
Ultra Flood
18° / 34° / 48°

14 ○ 34 ● 60 ● DL ●
E3 ● J6 ● Z5 ●





Bollard P. 708



140 x 500 mm

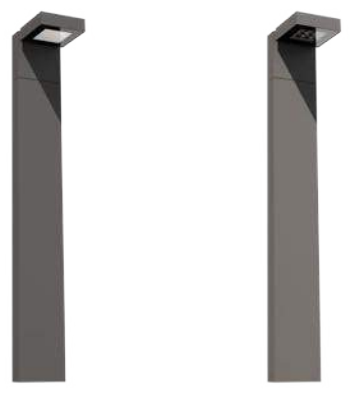

140 x 1000 mm

Opal
13,2 W



General light

Optics
21 W



Spot / Flood
Ultra Flood
18° / 34° / 48°

- 14 ○
- 34 ○
- 60 ●
- DL ●
- E3 ●
- J6 ●
- Z5 ●



Lamppost P. 742

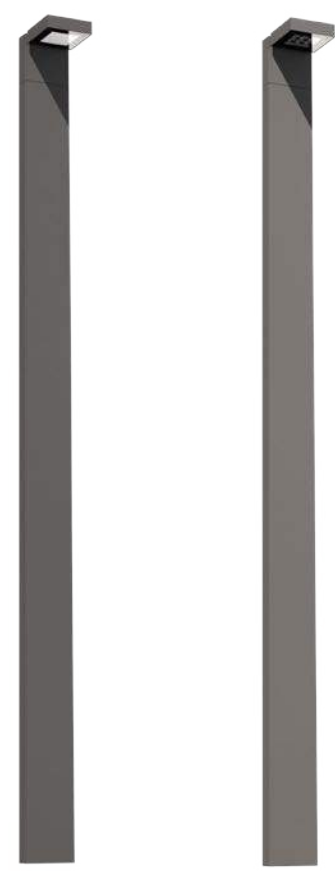

140 x 2300 mm

Opal
13,2 W



General light

Optics
21 W



Spot / Flood
Ultra Flood
18° / 34° / 48°

- 14 ○
- 34 ○
- 60 ●
- DL ●
- E3 ●
- J6 ●
- Z5 ●



Beleuchtungsanlagen Sistemi di illuminazione

Alle Mitglieder der Modis-Familie sind mit zwei Innenmodulen erhältlich, bei denen je nach den Anforderungen der zu beleuchtenden Umgebung zwischen Opal- und Optics-Optik gewählt werden kann. Die Opal-Variante ist für die Grundbeleuchtung vorgesehen und mit der Optik-Option kann der Lichtschein zum Hervorheben von einzelnen Objekten oder Szenen gebündelt werden, wobei die Optiken Spot 18°, Medium 34° und Flood 48° zur Auswahl stehen. Darüber hinaus bietet die Optics-Variante einen hervorragenden visuellen Komfort (UGR<16) und eine hohe Lichtqualität (CRI90).

In tutta la famiglia Modis presenta due moduli interni a scelta tra ottica Opal e Optics, in base alle esigenze dell'ambiente da illuminare. La versione Opal offre un'illuminazione generale mentre l'opzione Optics consente di concentrare il fascio per mettere in risalto oggetti o scene concrete, con la possibilità di scegliere tra ottica Spot 18°, Medium 34° e Flood 48°. Inoltre, la versione Optics offre un grande comfort visivo (UGR<16) e una luce di qualità (CRI90).



Opal



Optics

Verfügbare Farben Colori disponibili

Modis wird standardmäßig in der Farbe dunkelgrau geliefert und ist außerdem in dem Farbtönen der individuellen Farbpalette The Colours von LEDS C4 erhältlich.

Modis è disponibile nel colore grigio scuro di serie e anche nella gamma personalizzata The Colours di LEDS C4.



Drehung des Leuchtenkopfs Rotazione della testa

Die Homogenität des Modis-Profiles in seinen verschiedenen Anwendungen ermöglicht es durch strategische Anordnung verschiedener Modelle der Kollektion ausgewogene Atmosphären zu schaffen. Die Schaffung einer perfekten Lichtszene wird durch die mögliche Drehung des Leuchtenkopfs um 350° in seitlicher und um 180° in vertikaler Richtung erleichtert und bietet damit völlige Freiheit bei der lichttechnischen Gestaltung des Raums.

L'omogeneità nel profilo di Modis nelle sue varie applicazioni, consente di creare ambienti equilibrati con vari articoli della collezione collocati in modo strategico. La creazione di una scena di illuminazione perfetta viene inoltre completata dalla rotazione della testa, che permette un movimento di 350° verso i lati e di 180° verso l'alto e verso il basso, offrendo così una totale libertà di intervento nello spazio da illuminare.

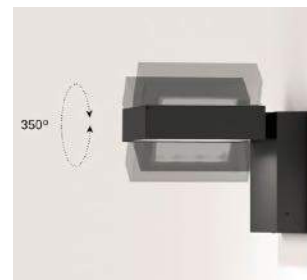
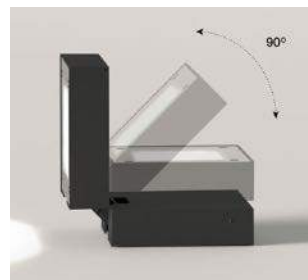
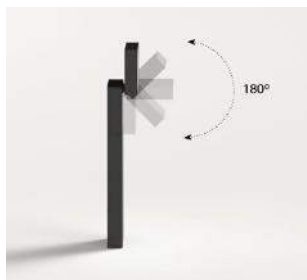

CCT-Technologie Tecnologia CCT

Die mit dem Ensemble geschaffene Atmosphäre wird durch die Möglichkeit ergänzt, über einen Schalter die Farbtemperatur (2700K / 3200K / 4000K) zu wählen, der in allen Modis Opal-Varianten bereits in der Artikelbestellung enthalten ist. Bei Modis Optics hingegen können Sie bei der Bestellung zwischen den Farbtemperaturen 2700K, 3000K und 4000K wählen.

L'ambientazione dell'insieme si completa con la possibilità di scegliere la temperatura di colore (2700K / 3200K / 4000K), grazie a un interruttore incorporato in tutte le versioni Modis Opal che partono da un unico riferimento. D'altra parte, Modis Optics permette di scegliere la temperatura di colore al momento dell'acquisto, a scelta tra 2700K, 3000K e 4000K.

Verschiedenes Zubehör Varietà di accessori

Alle Modis-Leuchten können auf Wunsch mit einer Blende ausgestattet werden, um den Lichtkomfort zu verbessern und die Blendungswirkung zu reduzieren. Die Bodenmodelle sind mit einem Haltepflock erhältlich, um die Installation auf Rasen oder sonstigen weichen Untergründen zu ermöglichen. Als weiteres Zubehör und Alleinstellungsmerkmal der Kollektion sind unterschiedliche Profile lieferbar, mit denen die Leuchten in Reihe geschaltet und so komplette vollständige Beleuchtungssysteme geplant werden können.

A tutti gli apparecchi della linea Modis è possibile aggiungere una visiera opzionale per migliorare il comfort visivo e ridurre così l'abbagliamento. Inoltre, le versioni da pavimento consentono l'aggiunta di un paletto per installazioni su prato o altre superfici morbide. Altri utili accessori, che davvero segnano la differenza della collezione, sono i vari profili che consentono di montare gli apparecchi in serie, trasformandoli così in veri e completi sistemi di illuminazione.

Smart

Bezüglich der Ansteuerung sind die Modelle der Modis-Kollektion neben den Schalloptionen EIN/AUS und DALI auch mit integrierter Casambi-Technologie erhältlich, die jederzeit eine individuelle und ferngesteuerte Kontrolle aller Leuchten und eine präzise und bedarfsgerechte Regelung der Helligkeit ermöglicht.

Oltre a essere disponibili in versione ON/OFF e DALI, la collezione Modis dispone di versioni con tecnologia Casambi integrata, che consente un controllo individuale e remoto di ciascuno degli apparecchi e la gestione esatta della luminosità in base alle esigenze di ogni momento.

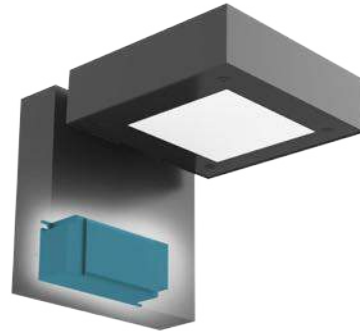

Smart-Funktionen: Energieeinsparung Funzionalità Smart: Risparmio energetico

Die Smart-Technologie der Modis-Modelle ermöglicht es unter anderem, die Leuchten entsprechend der Anwesenheit von Personen zu steuern und so unnötigen Energieverbrauch zu reduzieren, indem die Leuchte bei Abwesenheit ausgeschaltet oder gedimmt werden kann.

Una delle funzionalità della tecnologia Smart nella linea Modis consiste nel controllo delle luci in funzione della presenza, aiutando così a ridurre il consumo energetico non necessario grazie allo spegnimento o alla regolazione della luce in assenza di persone.





MODIS

Modis Opal Wall Fixture/Spotlight/ Ceiling

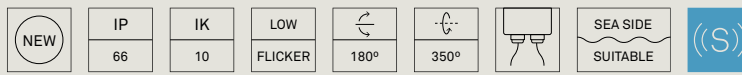

14* ○ 34* ● 60* ● DL* ● E3* ● J6* ● Z5 ●

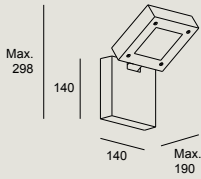

LED						
K	CRI	W LED	W Total	Real Lm	Code	
SW 2700-3200-4000	80	11.6	13.2	744	14	
					34	
					60	DU
					DL	OU
					E3	XB
					J6	
Z5						

XB	Casambi	220-240V	50-60Hz
DU	DALI-2	100-277V	50-60Hz
OU	ON-OFF	100-277V	50-60Hz



nicht inklusive / Non incluso	
Pflock 235 mm / Paletto 235mm	71-9997-05-05
Pflock 302mm / Paletto 302mm	71-9998-05-05



14* ○ 34* ● 60* ● DL* ● E3* ● J6* ● Z5 ●

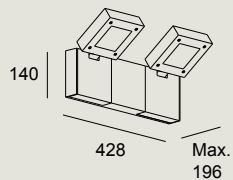

LED						
K	CRI	W LED	W Total	Real Lm	Code	
SW 2700-3200-4000	80	11.6	26.4	1488	14	
					34	
					60	DU
					DL	OU
					E3	XB
					J6	
Z5						

XB	Casambi	220-240V	50-60Hz
DU	DALI-2	100-277V	50-60Hz
OU	ON-OFF	100-277V	50-60Hz



nicht inklusive / Non incluso	
Verkettungszubehör Leuchtenkopf extra weiß / Access. extra di collegamento in serie testa bianco	71-E235-14-00
Verkettungszubehör Leuchtenkopf extra schwarz / Access. extra di collegamento in serie testa nero	71-E235-60-00
Verkettungszubehör Leuchtenkopf extra hellgrau / Access. extra di collegamento in serie testa grigio chiaro	71-E235-34-00
Verkettungszubehör Leuchtenkopf extra braun / Access. extra di collegamento in serie testa marrone	71-E235-J6-00
Verkettungszubehör Leuchtenkopf tannengrün / Access. extra di collegamento in serie testa verde abete	71-E235-E3-00
Verkettungszubehör Leuchtenkopf extra gold / Access. extra di collegamento in serie testa dorato	71-E235-DL-00
Verkettungszubehör Leuchtenkopf extra grau / Access. extra di collegamento in serie testa grigio	71-E235-Z5-00

MODIS

Modis Opal Wall Fixture/Spotlight/ Ceiling

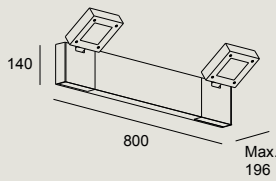

NEW	IP 66	IK 10	LOW FLICKER	180°	350°	SEA SIDE SUITABLE	BREEAM	SWITCH CCT SW 2700-3200-4000	(S)
-----	----------	----------	----------------	------	------	----------------------	--------	---------------------------------	-----

14* ○ 34* ● 60* ● DL* ● E3* ● J6* ● Z5 ●

LED						
K	CRI	W LED	W Total	Real Lm	Code	
SW 2700-3200-4000	80	11.6	26.4	1488	14	
					34	
					60	DU
					E3	OU
					J6	XB
					Z5	

XB	Casambi	220-240V	50-60Hz
DU	DALI-2	100-277V	50-60Hz
OU	ON-OFF	100-277V	50-60Hz



nicht inklusive / Non incluso		
Verkettungszubehör Leuchtenkopf extra weiß / Access. extra di collegamento in serie testa bianco		71-E235-14-00
Verkettungszubehör Leuchtenkopf extra schwarz / Access. extra di collegamento in serie testa nero		71-E235-60-00
Verkettungszubehör Leuchtenkopf extra hellgrau / Access. extra di collegamento in serie testa grigio chiaro		71-E235-34-00
Verkettungszubehör Leuchtenkopf extra braun / Access. extra di collegamento in serie testa marrone		71-E235-J6-00
Verkettungszubehör Leuchtenkopf tannengrün / Access. extra di collegamento in serie testa verde abete		71-E235-E3-00
Verkettungszubehör Leuchtenkopf extra gold / Access. extra di collegamento in serie testa dorato		71-E235-DL-00
Verkettungszubehör Leuchtenkopf extra grau / Access. extra di collegamento in serie testa grigio		71-E235-Z5-00

nicht mitgeliefertes allgemeines Zub. Access. comuni non inclusi		
Blende weiß Visiera bianca		71-E234-14-00
Blende hellgrau Visiera grigio chiaro		71-E234-34-00
Blende schwarz Visiera nera		71-E234-60-00
Blende gold Visiera dorata		71-E234-DL-00
Blende tannengrün Visiera verde abete		71-E234-E3-00
Blende braun Visiera marrone		71-E234-J6-00
Blende grau Visiera grigia		71-E234-Z5-00

*Fragen Sie unser Verkaufsteam nach den Lieferbedingungen.
Consultare i termini e le condizioni di consegna al nostro team commerciale.

MODIS

Modis Optics Wall Fixture/Spotlight/ Ceiling

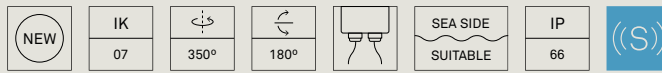

Codebeispiel / Esempio di codice: AS11-18V9S30UZ5

Model	W	K/ Cri/ Real lm	Optics	Source	Finishes
AS11 - 	18 18,3W	V9 2700K CRI90/1301 lm	S3 16°	OU ON-OFF 100-277V 50-60Hz	Z5
		W9 3000K CRI90/1301 lm	M3 33°	DS DALI-2 220-240V 50-60Hz	14*
		X9 4000K CRI90/1301 lm	F1 48°	XB CASAMBI 220-240V 50-60Hz	60* 34* J6* E3* DL*

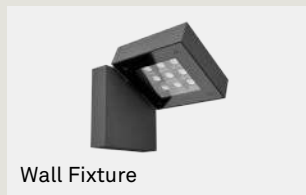

nicht inklusive / Non incluso	
Pflock 235 mm / Paletto 235mm	71-9997-05-05
Pflock 302mm / Paletto 302mm	71-9998-05-05



Codebeispiel / Esempio di codice: AS12-37V9S30UZ5

Model	W	K/ Cri/ Real lm	Optics	Source	Finishes
AS12 - 	37 36,6W	V9 2700K CRI90/2602 lm	S3 16°	OU ON-OFF 100-277V 50-60Hz	Z5
		W9 3000K CRI90/2602 lm	M3 33°	DS DALI-2 220-240V 50-60Hz	14*
		X9 4000K CRI90/2602 lm	F1 48°	XB CASAMBI 220-240V 50-60Hz	60* 34* J6* E3* DL*

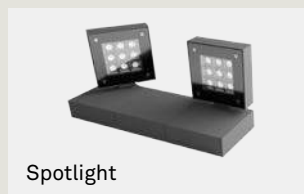









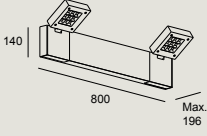

nicht inklusive / Non incluso	
Verkettungszubehör Leuchtenkopf extra weiß / Access. extra di collegamento in serie testa bianco	71-E235-14-00
Verkettungszubehör Leuchtenkopf extra schwarz / Access. extra di collegamento in serie testa nero	71-E235-60-00
Verkettungszubehör Leuchtenkopf extra hellgrau / Access. extra di collegamento in serie testa grigio chiaro	71-E235-34-00
Verkettungszubehör Leuchtenkopf extra braun / Access. extra di collegamento in serie testa marrone	71-E235-J6-00
Verkettungszubehör Leuchtenkopf tannengrün / Access. extra di collegamento in serie testa verde abete	71-E235-E3-00
Verkettungszubehör Leuchtenkopf extra gold / Access. extra di collegamento in serie testa dorato	71-E235-DL-00
Verkettungszubehör Leuchtenkopf extra grau / Access. extra di collegamento in serie testa grigio	71-E235-Z5-00

MODIS

Modis Optics Wall Fixture/Spotlight/ Ceiling



Codebeispiel / Esempio di codice: AS13-37V9S30UZ5

Model	W	K/ Cri/ Real lm	Optics	Source	Finishes
AS13 - 	37 36,6W	V9 2700K CRI90/2602 lm	S3 16°	OU  ON-OFF 100-277V 50-60Hz	Z5 
		W9 3000K CRI90/2602 lm	M3 33°	DS  DALI-2 220-240V 50-60Hz	14* 
		X9 4000K CRI90/2602 lm	F1 48°	XB  CASAMBI 220-240V 50-60Hz	60* 
					34* 
					J6* 
					E3* 
					DL* 



nicht inklusive / Non incluso	
Verkettungszubehör Leuchtenkopf extra weiß / Access. extra di collegamento in serie testa bianco	71-E235-14-00
Verkettungszubehör Leuchtenkopf extra schwarz / Access. extra di collegamento in serie testa nero	71-E235-60-00
Verkettungszubehör Leuchtenkopf extra hellgrau / Access. extra di collegamento in serie testa grigio chiaro	71-E235-34-00
Verkettungszubehör Leuchtenkopf extra braun / Access. extra di collegamento in serie testa marrone	71-E235-J6-00
Verkettungszubehör Leuchtenkopf tannengrün / Access. extra di collegamento in serie testa verde abete	71-E235-E3-00
Verkettungszubehör Leuchtenkopf extra gold / Access. extra di collegamento in serie testa dorato	71-E235-DL-00
Verkettungszubehör Leuchtenkopf extra grau / Access. extra di collegamento in serie testa grigio	71-E235-Z5-00

nicht mitgeliefertes allgemeines Zub. Access. comuni non inclusi	Blende weiß Visiera bianca	71-E234-14-00
	Blende hellgrau Visiera grigio chiaro	71-E234-34-00
	Blende schwarz Visiera nera	71-E234-60-00
	Blende gold Visiera dorata	71-E234-DL-00
	Blende tannengrün Visiera verde abete	71-E234-E3-00
	Blende braun Visiera marrone	71-E234-J6-00
	Blende grau Visiera grigia	71-E234-Z5-00

*Fragen Sie unser Verkaufsteam nach den Lieferbedingungen.

Consultare i termini e le condizioni di consegna al nostro team commerciale.

MODIS

Modis Opal Bollard

NEW	IP 66	IK 10	LOW FLICKER	350°	90°	SEA SIDE SUITABLE	BREEAM	SWITCH CCT SW 2700-3200-4000	(S)
-----	----------	----------	----------------	------	-----	----------------------	--------	---------------------------------	-----

14* 34* 60* DL* E3* J6* Z5

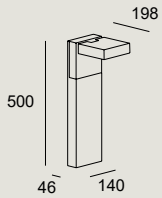

LED						
K	CRI	W LED	W Total	Real Lm	Code	
SW 2700-3200-4000	80	11.6	13.2	744	14	
					34	
					60	DU
					E3	OU
					J6	XB
					Z5	

XB Casambi
DU DALI-2
OU ON-OFF

NEW	IP 66	IK 10	LOW FLICKER	350°	90°	SEA SIDE SUITABLE	BREEAM	SWITCH CCT SW 2700-3200-4000	(S)
-----	----------	----------	----------------	------	-----	----------------------	--------	---------------------------------	-----

14* 34* 60* DL* E3* J6* Z5

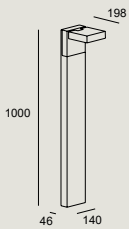

LED						
K	CRI	W LED	W Total	Real Lm	Code	
SW 2700-3200-4000	80	11.6	13.2	744	14	
					34	
					60	DU
					E3	OU
					J6	XB
					Z5	

XB Casambi
DU DALI-2
OU ON-OFF

*Fragen Sie unser Verkaufsteam nach den Lieferbedingungen.







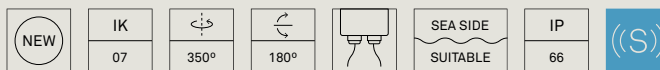



Consultare i termini e le condizioni di consegna al nostro team commerciale.

MODIS

Modis Optics Bollard





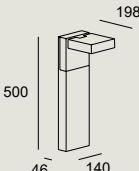







Codebeispiel / Esempio di codice: AS14-18V9S30UZ5

Model	W	K/ Cri/ Real lm	Optics	Source	Finishes
 AS14 - 180°	18 18,3W	V9 2700K CRI 90/1301 lm	S3 16°	OU  ON-OFF 100-277V 50-60Hz	Z5  14*  60*  34*  J6*  E3*  DL* 
		W9 3000K CRI90/1301 lm	M3 33°	DS  DALI-2 220-240V 50-60Hz	
		X9 4000K CRI90/1301 lm	F1 48°	XB  CASAMBI 220-240V 50-60Hz	
					

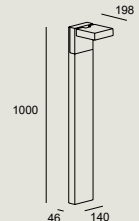

Codebeispiel / Esempio di codice: AS15-18V9S30UZ5

Model	W	K/ Cri/ Real lm	Optics	Source	Finishes
 AS15 - 180°	18 18,3W	V9 2700K CRI90/1301lm	S3 16°	OU  ON-OFF 100-277V/ 50-60Hz	Z5  14*  60*  34*  J6*  E3*  DL* 
		W9 3000K CRI90/1301 lm	M3 33°	DS  DALI-2 220-240V 50-60Hz	
		X9 4000K CRI90/1301 lm	F1 48°	XB  CASAMBI 220-240V 50-60Hz	
					

nicht mitgeliefert
allgemeines Zub.
Access. comuni non inclusi

Blende weiß Visiera bianca	71-E234-14-00
Blende hellgrau Visiera grigio chiaro	71-E234-34-00
Blende schwarz Visiera nera	71-E234-60-00
Blende gold Visiera dorata	71-E234-DL-00
Blende tannengrün Visiera verde abete	71-E234-E3-00
Blende braun Visiera marrone	71-E234-J6-00
Blende grau Visiera grigia	71-E234-Z5-00
Befestigungsbolzen Perni di fissaggio	71-E363-48-48

*Fragen Sie unser Verkaufsteam nach den Lieferbedingungen.

Consultare i termini e le condizioni di consegna al nostro team commerciale.

MODIS

Modis Opal Lampost



14* 34* 60* DL* E3* J6* Z5

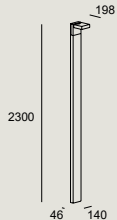

LED						
K	CRI	W LED	W Total	Real Lm	Code	
SW 2700-3200-4000	80	11.6	13.2	744	14	
					34	
					60	DU
					E3	OU
					J6	XB
		Z5				

	XB Casambi
	DU DALI-2
	OU ON-OFF

MODIS

Modis Optics Lampost



Codebeispiel / Esempio di codice: AS16-18V9S30UZ5

Model	W	K/ Cri/ Real lm	Optics	Source	Finishes
 AS16 - ↻180°	18 18,3W	V9 2700K CRI90/1301 lm	S3 16°	OU ON-OFF 100-277V 50-60Hz	Z5
		W9 3000K CRI90/1301 lm	M3 33°	DS DALI-2 220-240V 50-60Hz	14*
		X9 4000K CRI90/1301 lm	F1 48°	XB CASAMBI 220-240V 50-60Hz	60*
					34*
					J6*
					E3*
					DL*

mitgeliefertes allgemeines Zub. Befestigungssystem zum Erdeinbau
Access. comuni inclusi Sistema di fissaggio per interrimento nel suolo

nicht mitgeliefertes allgemeines Zub. Access. comuni non inclusi	Blende weiß Visiera bianca	71-E234-14-00
	Blende hellgrau Visiera grigio chiaro	71-E234-34-00
	Blende schwarz Visiera nera	71-E234-60-00
	Blende gold Visiera dorata	71-E234-DL-00
	Blende tannengrün Visiera verde abete	71-E234-E3-00
	Blende braun Visiera marrone	71-E234-J6-00
	Blende grau Visiera grigia	71-E234-Z5-00

*Fragen Sie unser Verkaufsteam nach den Lieferbedingungen.
Consultare i termini e le condizioni di consegna al nostro team commerciale.



Lineare Beleuchtungssysteme

Sistemi lineari d'illuminazione

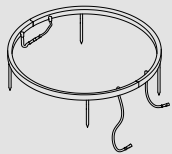

Vercle

487

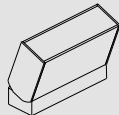

Taglio

493

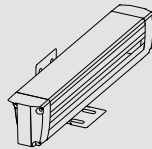

Convert

517

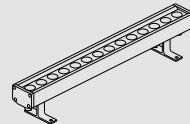

Tron

522



Afrodita

527

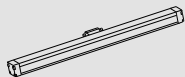

Mex

533



Vercle

ARTEC3 STUDIO 2021

BODY MAT		50000h	3
AL		L80 B20	MacAdam



Vercle ist eine Kollektion von linearen und geschwungenen Systemen zur Beleuchtung von Außenbereichen wie Blumenkästen und Bäumen oder Objekten wie Skulpturen oder Gebäuden. Bei dieser Kollektion steht das Licht im Vordergrund. Sie erzeugt eine weiche, indirekte Beleuchtung mit hohem visuellem Komfort, die sich vollständig in die Umgebung einfügt.

Vercle è una collezione di sistema lineare e curva, che consente di illuminare perimetri di spazi esterni come aiuole e alberi e elementi come sculture o costruzioni. Questa collezione rende la luce protagonista, proiettando un'illuminazione morbida e dal gran comfort visivo, completamente integrata nell'ambiente.



Ringform
Formato ad anello



Lineare Form
Formato lineare

Minimalistisches und kompaktes Design Design minimal e compatto

Minimalistisch und kompakt im Design, ist Vercle mit nur 10 mm Breite x 17 mm Höhe, gerade so hoch, um die Technik unterzubringen, und kann so bündig abschließend im Boden eingebaut werden. So ist die Leuchte nahezu unsichtbar und perfekt im Raum integriert.

Con un design minimalista e innovativo, Vercle presenta il minimo spessore per la sua funzionalità, con una larghezza di soli 10mm x 17mm di altezza, può essere installato rasoterra, scomparendo e integrandosi perfettamente nell'ambiente.



17 mm Höhe
17 mm altezza

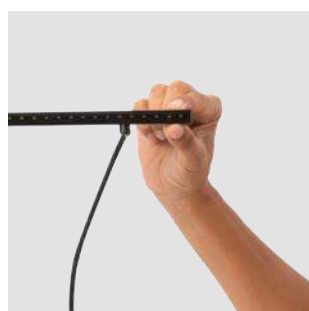

10 mm Breite
10 mm larghezza



Unterschiedliche Kompositionen Varie composizioni

Mit seinem unsichtbaren Anschlusssystem bietet Vercle verschiedene Verkettungsmöglichkeiten, bei denen lineare und ringförmige Formate verwirklicht werden können. Der doppelte Kabelausgang und die wasserdichten Stecker ermöglichen eine einfache und werkzeuglose Ringinstallation.

Veracle offre varie opzioni di concatenazione dove è possibile combinare il formato lineare e il formato ad anello grazie al sistema di unione invisibile. Include una doppia uscita del cavo e connettori stagni che semplificano l'installazione a catena senza bisogno di strumenti.



Anschluss sichtbarer Teil
Unione della parte a vista



Anschluss unten
Unione inferiore



Doppelter Kabelausgang
Doppia uscita cavo



Wasserdichter Stecker
Connettore stagno

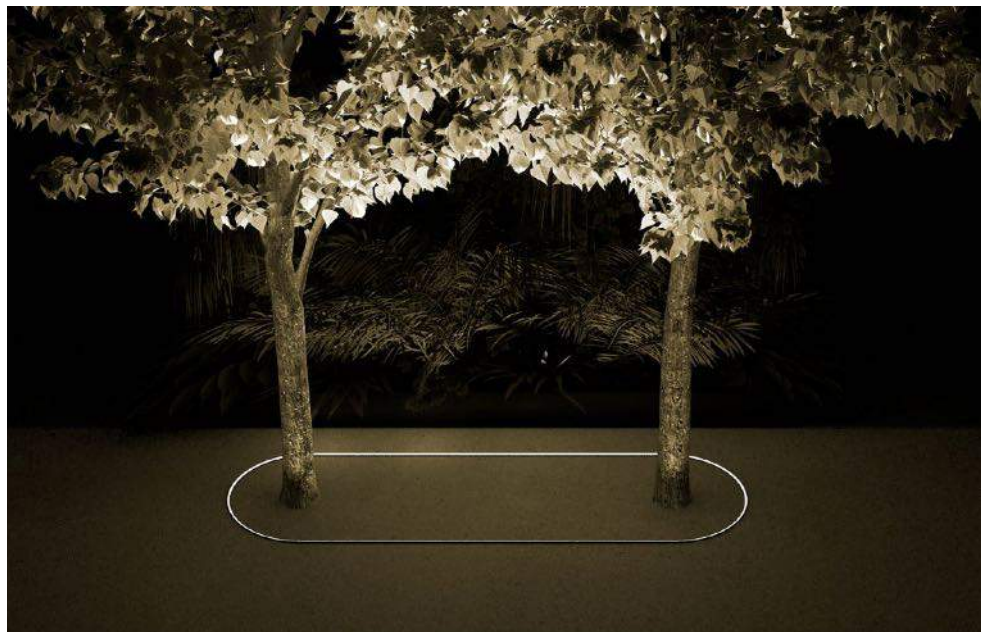

Hervorragender Sehkomfort Grande comfort visivo

Mit den kegelförmigen, schwarzen Blenden, der versenkten Anordnung der LEDs und dem leicht erhöhten Außenprofil bietet Vercle einen hohen visuellen Komfort.

Vercle offre un grande comfort visivo grazie ai profili conici in finitura nera, alla disposizione a incasso dei suoi LED e alla maggiore altezza della parte esterna del profilo rispetto al diffusore.



Höchste Langlebigkeit und Widerstandsfähigkeit Massima durabilità e resistenza.

Mit einem Gehäuse aus extrudiertem Aluminium, das die Lebensdauer des Produkts maximiert und seine Installation in nassen Umgebungen oder sogar direkt am Meer ermöglicht.

Viene fornito con un corpo in alluminio estruso, per massimizzare la vita utile del prodotto e agevolarne l'installazione in ambienti umidi e anche sul lungomare.

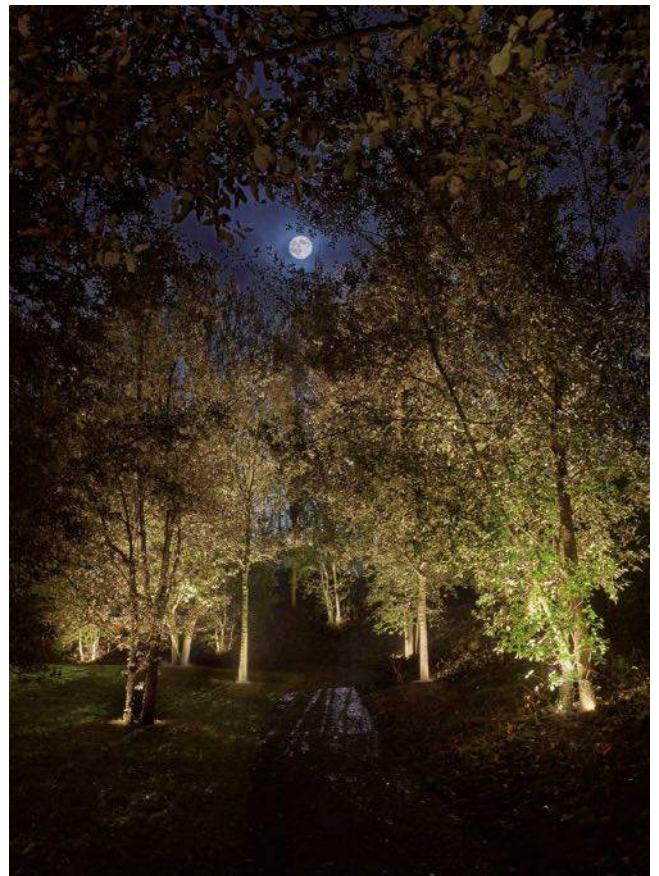



VERCLE

IP	IK		SEA SIDE SUITABLE	
65/67	10			

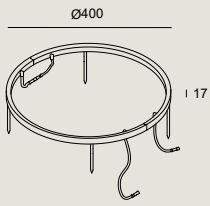
05 ●

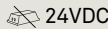

LED					
K	CRI	W LED	W Total	Real Lm	Code
3000	80	26	26	352	55-E117 - 05 - CL
 24VDC					

55-E117	IP		u. min	u. max		Code
				110-127V	220-240V	
		ON-OFF	1	6	9	71-6345-00-00
IP67		DALI	1	4	4	71-E099-00-00
		0-10V	1	4	4	71-E097-00-00
Optional IP66 IK09 box (300x200x105mm)						71-E100-00-00

① P. 946

IP	IK		SEA SIDE SUITABLE	
65/67	10			

05 ●

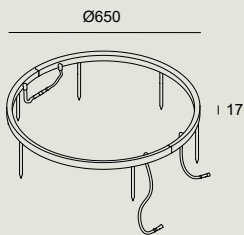

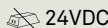
LED					
K	CRI	W LED	W Total	Real Lm	Code
3000	80	43.9	43.9	598	55-E118 - 05 - CL
 24VDC					

55-E118	IP		u. min	u. max		Code
				110-127V	220-240V	
		ON-OFF	1	4	5	71-6345-00-00
IP67		DALI	1	2	2	71-E099-00-00
		0-10V	1	2	2	71-E097-00-00
Optional IP66 IK09 box (300x200x105mm)						71-E100-00-00

① P. 946

VERCLE

IP	IK		SEA SIDE SUITABLE	
65/67	10			

05 ●

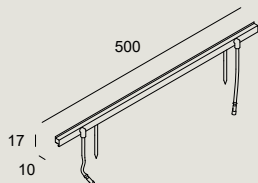

LED					
K	CRI	W LED	W Total	Real Lm	Code
3000	80	10.3	10.3	126	55-E119 - 05 - CL
 24VDC					

55-E119	IP		u. min	u. max		Code
				110-127V	220-240V	
IP68	ON-OFF		1	1	1	71-E101-05-05
	ON-OFF		1	9	9	71-6341-00-00
IP67	DALI		1	11	11	71-E099-00-00
	0-10V		1	11	11	71-E097-00-00
Optional IP66 IK09 box (300x200x105mm)						71-E100-00-00

 P. 946

IP	IK		SEA SIDE SUITABLE	
65/67	10			

05 ●

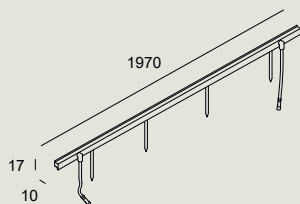

LED					
K	CRI	W LED	W Total	Real Lm	Code
3000	80	42.5	42.5	519	55-E120 - 05 - CL
 24VDC					

55-E120	IP		u. min	u. max		Code
				110-127V	220-240V	
IP68	ON-OFF		1	4	5	71-6345-00-00
	DALI		1	2	2	71-E099-00-00
IP67	0-10V		1	2	2	71-E097-00-00
	Optional IP66 IK09 box (300x200x105mm)					

 P. 946

mitgeliefertes allgemeines Zub. Erdspieß
Access. comuni inclusi Picchetto

Wasserdichte Steckverbinder nach IP68
Connettori stagni IP68

nicht mitgeliefertes allgemeines Zub.
Access. comuni non inclusi

IP68- Antikondensationsstecker mit 2 Eingängen
Connettore IP68 con valvola anticondensa a 2 ingressi 71-E112-00-00

5-m-Kabel mit wasserdichten Schnellsteckverbindern
Cavo da 5m con connettori rapidi a tenuta stagna 71-E118-05-05

IP68- Antikondensationsstecker mit 4 Eingängen
Connettore IP68 con valvola anticondensa a 4 ingressi 71-E122-00-00

Smart Compatible-Zub.
Access. Smart Compatibile

Driver Casambi PWM 1ch IP66 71-A242-00-00



Taglio

Opal P. 498

Surface
Wall / Ceiling / Floor



111 x 35 mm



504 x 35 mm



1004 x 35 mm

1,2 W -15,4 W

14 ○ 54 ○ 60 ●
DL ● E3 ● J6 ●
Z5 ●



Recessed
Floor



111 x 65 mm



504 x 65 mm



1004 x 40 mm



1004 x 65 mm

1,2 W a 15,4 W

M3 ○



Optics P. 500

Surface
Wall / Ceiling / Floor



111 x 35 mm



504 x 35 mm



1004 x 35 mm

4-38 W



Medium 23°

14 ○ 54 ○ 60 ●
DL ● E3 ● J6 ●
Z5 ●



Recessed
Floor



111 x 65 mm



504 x 65 mm



1004 x 65 mm

4-38 W



Medium 23°

37 ○



Indirect P. 502

Surface
Floor



1000 x 60 mm

9,6 W

54 ○



TAGLIO

BODY MAT		50000h
AL		L80 B20



Taglio Opal



Taglio Optics



Taglio Indirect

Taglio ist die perfekte lineare Lösung, um architektonische Räume hervorzuheben oder Kompositionen und Lichteffekte auf Böden, Decken und Wänden zu erzeugen. Die Kollektion besteht aus 3 Unterfamilien je nach eingesetztem optischen Modul: Indirect für sanftes Bodenflutlicht, Opal für die Grundbeleuchtung und Optics für fokussiertes Licht. Die Möglichkeit der unbegrenzten Reihenschaltung macht die Kollektion zum Nonplusultra der architektonischen Integration unter den Außenleuchten im Produktprogramm von LEDS C4. Die dabei mögliche Kombination von zwei verschiedenen Modultypen (Opal und Optics) ist ein weiteres Merkmal von Taglio, das die Reihe einzigartig auf dem Markt macht. Ein weiterer bedeutender Vorteil von Taglio ist die Vielseitigkeit. So gibt es Auf- und Einbaumodelle, verschiedene Baugrößen und verschiedene Farbtemperaturen zur Auswahl, einschließlich RGB-Licht. Alle Varianten werden mit Niederspannung (24 V DC) ferngespeist und sind regulierbar, um eine feinere Anpassung an die Projektanforderungen und höhere Energieeinsparungen zu ermöglichen.

Taglio è la soluzione lineare perfetta per rinforzare spazi architettonici o creare composizioni e giochi di luce su pavimenti, soffitti e pareti. È composta da 3 sottofamiglie in funzione dell'uso del modulo ottico: Indirect per bagni di luce tenue sul pavimento, Opal per luce generale e Optics per luce focalizzata. La possibilità di concatenazione infinita ha trasformato questa collezione nel massimo esponente dell'integrazione architettonica dell'offerta di illuminazione per esterni della LEDS C4. Inoltre, il fatto di poter concatenare anche 2 diversi tipi di moduli (Opal e Optics) rendono Taglio un punto di riferimento del mercato. La versatilità di Taglio è un'altro dei suoi vantaggi, in quanto non solo consente di scegliere tra versioni da incasso o da superficie, ma dispone anche di molte misure e temperature di colore, inclusa luce RGB. Tutte le versioni si alimentano da remoto a basso voltaggio (24V DC) e hanno la possibilità di essere regolate per una maggiore personalizzazione del progetto o un maggiore risparmio energetico.

Kippprofil Profilo basculante

Bei den Aufbaumodellen Taglio Opal und Taglio Optics kann die Leuchte gekippt werden. Das macht sie äußerst vielseitig, denn der Lichtschein kann bei der Installation ohne Werkzeugeinsatz schnell und sicher exakt auf den gewünschten Bereich im Raum ausgerichtet werden. Die Leuchte ist außerdem mit einem Feststellmechanismus ausgestattet, sodass sie nach der Installation sicher in der eingestellten Position bleibt und die Robustheit des Systems sichergestellt ist. Wird die Kippfunktion nicht benötigt, kann die mitgelieferte Kipphalterung leicht abgenommen werden, wodurch die Leuchte noch kompakter wird und leichter in die Architektur integrierbar ist.

Le versioni da superficie di Taglio Opal e Taglio Optics consentono di muovere l'apparecchio. Questo le conferisce una grande versatilità poiché, in maniera rapida e sicura, senza bisogno di attrezzi, è possibile dirigere il fascio di luce verso la zona esatta di ciascuno spazio durante l'installazione. Inoltre dispone di un sistema antiblocco incluso per far sì che, una volta installato, l'apparecchio resti saldamente fissato, garantendo così la robustezza del sistema. Se l'effetto basculante non è necessario, è possibile rimuovere l'accessorio di fissaggio basculante incluso, ottenendo un apparecchio ancora più compatto e integrato nell'architettura.



Unendliche Reihenschaltung Concatenazione infinita

Die Taglio-Kollektion ermöglicht eine unbegrenzte Reihenschaltung von Wand-, Boden- und Deckenleuchten, wodurch die vollständige Integration des Lichts in die Architektur erreicht wird. Darüber hinaus können die Varianten Opal und Optics kombiniert werden, um Abschnitte mit Grundbeleuchtung oder fokussierter Beleuchtung innerhalb des gleichen Profils zu schaffen. Es wird empfohlen, die Einbauversionen ausschließlich in den Boden einzubauen.

La collezione Taglio consente di concatenare all'infinito apparecchi su pareti, pavimenti e soffitti per ottenere una completa integrazione della luce nell'architettura. Inoltre, consente di combinare le versioni Opal e Optics per ottenere sezioni con un'illuminazione generale o focalizzata sempre con uno stesso profilo. Si consiglia di installare le versioni da incasso solo nel pavimento.

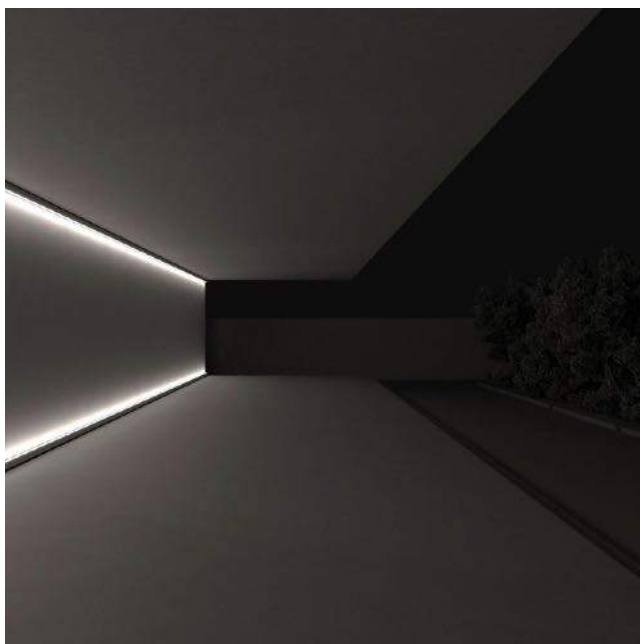

Reihenschaltung von Taglio Opal in Aufbaumontage an Boden und Decke.
Concatenazione di Taglio Opal da superficie su pavimento e tetto.



Reihenschaltung von Taglio Opal und Optics in Aufbaumontage an der Decke.
Concatenazione di Taglio Opal e Optics da superficie su soffitto.

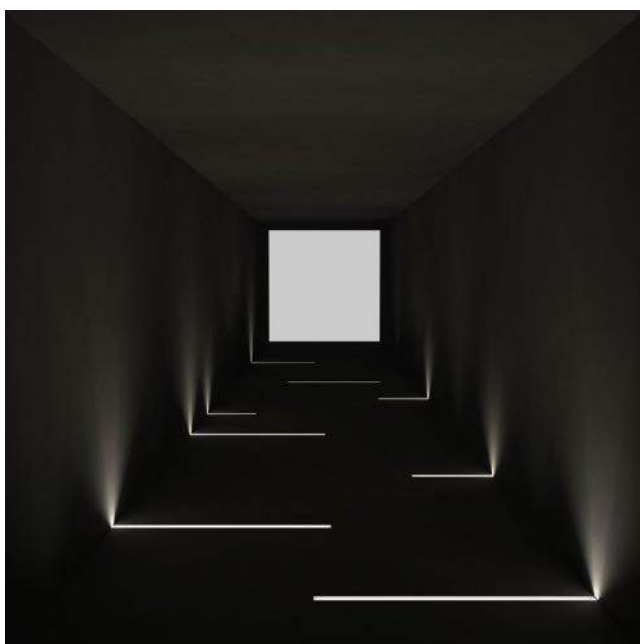

Taglio Opal als Bodeneinbauleuchte.
Taglio Opal da incasso su pavimento.

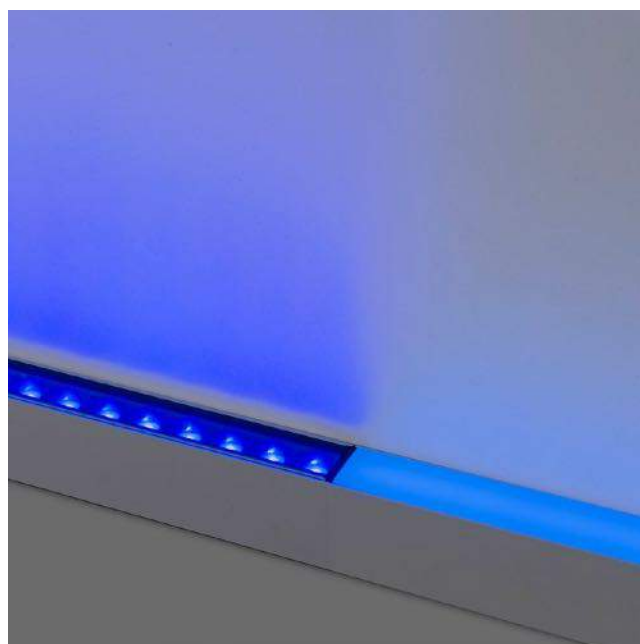

Reihenschaltung Taglio Opal und Optics.
Concatenazione Taglio Opal e Optics.

Farbauswahl Colour options

Verfügbar mit zwei Farbtemperaturen (3000K und 4000K), um eine einfache Anpassung an alle Projekte und Räume zu ermöglichen.

Disponibile in due temperature di colore (3000K e 4000K) e RGB per adattarsi a tutti i progetti e a tutti gli spazi.



Erhältliche Ausführungen Finiture disponibili

Die Aufbauvarianten von Taglio Optics und Opal werden standardmäßig in eloxiertem Aluminium angeboten und können zudem mit allen Farben aus dem The Colors-Katalog von LEDS C4 individuell gestaltet werden.

Le versioni da superficie di Taglio Optics e Opal sono disponibili in finitura alluminio anodizzato di serie e sono inoltre personalizzabili con tutte le finiture The Colors del catalogo LEDS C4.



Verlängerungsarme Bracci dilatatori

Als optionales Zubehör können die Aufbaumodelle von Taglio Optics und Opal mit zwei unterschiedlich langen Verlängerungsarmen ausgestattet werden, um die Taglio-Profile in gewissem Abstand von der Wand installieren zu können und damit Fassaden oder sonstige architektonische oder monumentale Elemente mit absoluter Präzision zu beleuchten.

Come accessori opzionali le versioni da superficie di Taglio Optics e Opal dispongono di bracci dilatatori di misure diverse che consentono di fissare i profili Taglio lontani dal muro, e di illuminare così con totale precisione facciate o altri elementi architettonici o monumentali.



Einfache Installation Installazione facile

Das umfangreiche und sinnvolle Zubehör ist der Schlüsselfaktor dafür, dass die Taglio-Kollektion von C4 LEDS bei Installateuren besonders beliebt ist. Alle Varianten sind mit wasserdichten Schnellverbindern ausgestattet, die werkzeuglos montiert werden können, und werden mit drei Metallplatten zur Verbindung der Profile untereinander geliefert. So kann aus Einzelmodulen ein großes feststehendes Modul konstruiert werden. Die Einbauversion verfügt außerdem über eine obere Abdeckung, um das Eindringen von Zement während der Installation zu verhindern, sowie über elastische Streifen an den Seiten, um den Ausbau des LED-Moduls im Falle einer Störung zu erleichtern.

Gli utili accessori disponibili sono il fattore chiave che rende la collezione Taglio LEDS C4 la preferita del mercato dagli installatori. Tutte le versioni includono connettori rapidi stagni installabili senza bisogno di attrezzi e 3 placche metalliche per unire tra loro i profili, trasformando moduli separati in un unico grande modulo inamovibile. La versione da incasso, inoltre, comprende un coperchio superiore per impedire l'ingresso del cemento durante l'installazione e bande elastiche per semplificare l'estrazione del modulo LED in caso di guasto.



Smart-Funktion: Zeitliche Programmierung Funzionalità Smart: Programmazioni orarie

Mit Smart Compatible (über das geeignete Smart-Zubehör) können die Effekte der linearen Beleuchtung mit der Flexibilität eines vernetzten Systems kombiniert werden. Damit kann beispielsweise eine Zeitschaltung der Leuchten verwirklicht werden.

Agli effetti dell'illuminazione lineare si aggiunge la flessibilità di un sistema connettivo, grazie alla caratteristica Smart Compatible (tramite relativo accessorio Smart), il che consente, ad esempio, di controllare le luci in base a un determinato orario.



TAGLIO OPAL



Taglio Opal ermöglicht die vollständige Integration in die Raumarchitektur verleiht ihm die Eleganz eines nahtlosen und gleichmäßigen Lichts mit hohem visuellem Komfort und vielen Installationsmöglichkeiten.

Taglio Opal si integra completamente nell'architettura dello spazio, donandolo dell'eleganza di una luce infinita e omogenea, con un gran comfort visivo e molte possibilità di installazione.



Varianten Versioni

Taglio Opal ist in 3 Längen erhältlich (10 cm, 50 cm und 1 m, in Reihe schaltbar) und wird in einer breiten Palette von Farbtemperaturen angeboten: 3000K, 4000K, RGB. Darüber hinaus ist eine ultrakompakte Einbauversion mit 3000K und 4000K und einer Profilbreite von nur 1,1 cm erhältlich, die speziell für die Erzeugung extrem subtiler und stimmungsvoller linearer Weißlichteffekte entwickelt wurde.

Taglio Opal è disponibile in 3 lunghezze (10 cm, 50 cm e 1 m, tutte concatenabili) e con una gamma completa di temperature di colore: 3000K, 4000K, RGB. Inoltre, esiste una versione da incasso ultra compatta disponibile in 3000K e 4000K con un profilo di soli 1,1 cm di larghezza, disegnato appositamente per creare effetti estremamente sottili e evocatori di una luce bianca lineare.



Profil 1,1 cm breit
Profilo da 1,1 cm di larghezza



Profil 3,2 cm breit
Profilo da 3,2 cm di larghezza

Homogene Beleuchtung und hoher Lichtkomfort Illuminazione omogenea e elevato comfort visivo

Taglio Opal ermöglicht die vollkommen integrierte und unendliche Beleuchtung von Räumen mit gleichmäßigem Licht und hohem visuellen Komfort, wobei eine Blendwirkung ausgeschlossen ist.

Taglio Opal consente di illuminare spazi in modo integrato e infinito garantendo una luce totalmente omogenea senza ombre e con un elevato comfort visivo, evitando l'abbagliamento.



TAGLIO OPTICS



Taglio Optics wurde für die Erzeugung einer gerichteten und fokussierten Lichtwirkung entwickelt, um architektonische oder monumentale Details hervorzuheben. Mit der konzentrierten Optik und der zusätzlichen Verlängerungsarme sind mit denen sie in verschiedenen Abständen von der Wand entfernt werden können, sind die Leuchten zudem ideal als Wandflutleuchten geeignet.

Taglio Optics è stata progettata per creare un effetto di luce diretto e focalizzato, ideale per mettere in risalto dettagli architettonici o monumentali. Inoltre si rivela perfetta anche per il bagno di pareti, grazie alla sua ottica concentrata e ai suoi accessori bracci che consentono di posizionarla a varie distanze dalla parete.

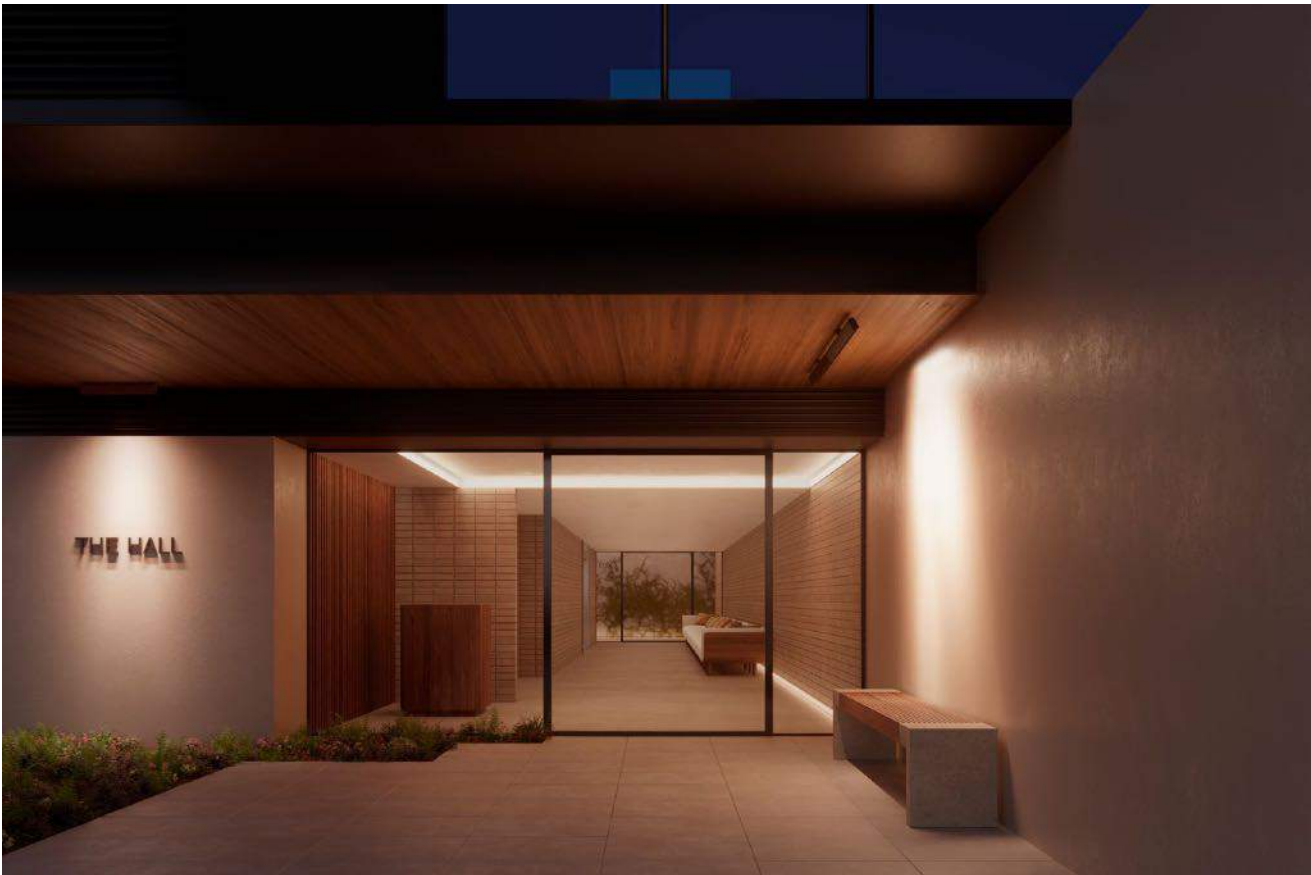

Varianten Versioni

Taglio Optics ist in 3 Längen erhältlich (10 cm, 50 cm und 1 m, in Reihe schaltbar) und wird in einer breiten Palette von Farbtemperaturen angeboten: 3000K, 4000K, RGB.

Taglio Optics è disponibile in 3 lunghezze (10 cm, 50 cm e 1 m, tutte concatenabili) e con una gamma completa di temperature di colore: 3000K, 4000K, RGB.

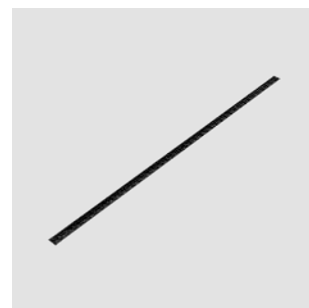
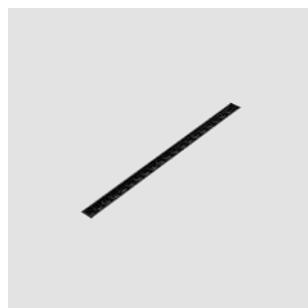

Hohe Effizienz und Dark-Light-Effekt Elevata efficienza e Effetto Dark Light

Taglio Optics zeichnet sich durch den hohen Wirkungsgrad der Optiken aus, die damit optimal in hochprofessionellen Projekten mit zu beantragender BREEAM-Zertifizierung eingesetzt werden können. Darüber hinaus bietet die Taglio Optics-Familie dank der Zierblenden und der versenkten Optik einen ausgezeichneten Lichtkomfort und kann als würdevoller Vertreter des Dark Light-Konzepts betrachtet werden, bei dem die Leuchte ausgeschaltet zu sein scheint, obwohl sie eingeschaltet ist.

Taglio Optics si contraddistingue per il rendimento delle sue ottiche, grazie alle quali può essere impiegata in progetti veramente professionali che devono rispettare la certificazione BREEAM. Inoltre, grazie alle sue schermature e alle ottiche profonde, la famiglia Taglio Optics offre un eccellente comfort visivo e può essere considerata una fedele seguace del concetto Dark Light, che si produce quando l'apparecchio sembra spento pur essendo acceso.



TAGLIO INDIRECT



Taglio Indirect ist die perfekte Lösung für eine sanfte und nahtlose Beleuchtung des Bodens, die sich mit hohem visuellem Komfort und vielen Installationsmöglichkeiten harmonisch in die Architektur einfügt.

Taglio Indirect è la soluzione perfetta per illuminare in maniera soffusa e infinita il pavimento, integrandosi nell'architettura e offrendo un elevato comfort visivo nonché molte possibilità di installazione.



Hoher visueller Komfort Grande comfort visivo

Taglio Indirect wird im unteren Wandbereich eingebaut und beleuchtet den Boden mit hohem Sehkraftkomfort, ohne Blendung und ohne Beeinträchtigung des Fußgängerverkehrs.

Installato nella parte inferiore della parete, Taglio Indirect illumina il pavimento con un elevato comfort visivo, evitando l'abbagliamento e senza interferire con il movimento dei pedoni.

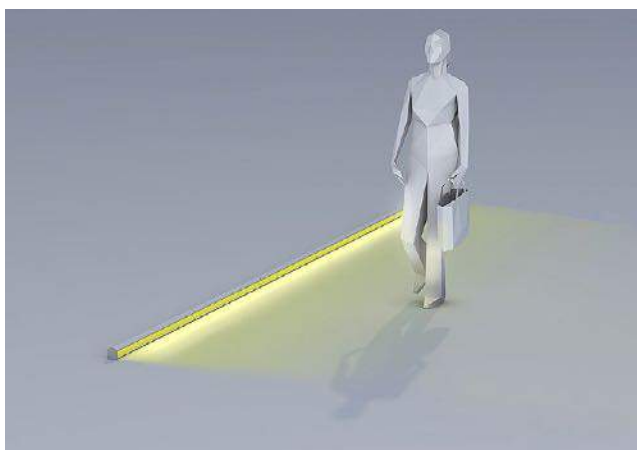

**Vielfältige
Installationsmöglichkeiten**
Numerose possibilità di
installazione

Dank dem vielseitigen Design können zwei Teile zur weiteren Aufwertung des Projekts gegenüberliegend installiert werden (1). Zudem enthalten sind Schnellsteckverbinder und drei Platten für eine perfekte Verbindung zwischen den verketteten Leuchten (2), wodurch sie sich ordnungsgemäß und problemlos in Ecken installieren lassen (3).

Il suo design versatile consente di installare due pezzi, uno di fronte all'altro, per una maggiore ricchezza del progetto (1). Inoltre, sono inclusi connettori rapidi e 3 piastre per garantire e facilitare una perfetta unione tra apparecchi installati in serie (2), che ne consente l'installazione corretta e senza difficoltà negli angoli (3).



1



2

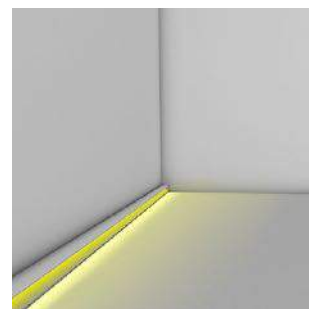

3

TAGLIO

Taglio Opal Surface



14* ○ 34* ● 54 ○ 60* ● DL* ● E3* ● J6* ● Z5* ●

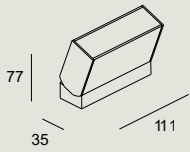

LED					
K	CRI	W LED	Real Lm	Code	
3000	80	1.2	65	14	
				34	
				54	
				60	15-E023 - DL - CL
				E3	
4000	80	1.2	65	14	
				34	
				54	
				60	15-E023 - DL - CM
				E3	
RGB		1.2	19	14	
				34	
				54	
				60	15-E024 - DL - 00
				E3	
				J6	
				Z5	

24VDC

15-E023	IP		u. min	u. max	Code
	IP68	ON-OFF	1	16	71-E101-05-05
		ON-OFF	1	20	71-E158-00-00
	IP67	DALI	1	30	71-E098-00-00
		0-10V	1	30	71-E094-00-00
	Optional IP66 IK09 box (300x200x105mm)				

① P. 946

Smart Compatible-Zub. / Access. Smart Compatibile
71-8050-00-00 Dimmer Casambi PWM 4ch IP20
71-A242-00-00 Driver Casambi PWM 1ch IP66

*Fragen Sie unser Verkaufsteam nach den Lieferbedingungen.

Consultare i termini e le condizioni di consegna al nostro team commerciale.

TAGLIO

Taglio Opal Surface



14* 34* 54 60* DL* E3* J6* Z5*

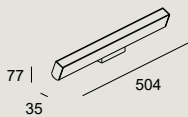

LED				
K	CRI	W LED	Real Lm	Code
3000	80	7.7	412	14
				34
				54
				60 - DL - CL
				E3
4000	80	7.7	412	14
				34
				54
				60 - DL - CM
				E3
RGB		8.4	99	14
				34
				54
				60 - DL - 00
				E3
				J6
				Z5

24VDC

15-E027	IP		u. min	u. max	Code
	IP68	ON-OFF	1	2	71-E101-05-05
		ON-OFF	1	7	71-E159-00-00
	IP67	DALI	1	7	71-E098-00-00
		0-10V	1	7	71-E096-00-00
	Optional IP66 IK09 box (300x200x105mm)				71-E100-00-00

P. 946

Smart Compatible-Zub. / Access. Smart Compatibile
71-8050-00-00 Dimmer Casambi PWM 4ch IP20
71-A242-00-00 Driver Casambi PWM 1ch IP66

*Fragen Sie unser Verkaufsteam nach den Lieferbedingungen.
Consultare i termini e le condizioni di consegna al nostro team commerciale.

TAGLIO

Taglio Opal Surface



14* ○ 34* ● 54 ○ 60* ● DL* ● E3* ● J6* ● Z5* ●

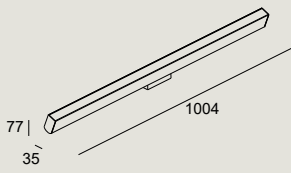

LED					
K	CRI	W LED	Real Lm	Code	
3000	80	14.7	824	14	15-E031 - CL
				34	
				54	
				60	
				DL	
				E3	
4000	80	14.7	824	14	15-E031 - CM
				34	
				54	
				60	
				DL	
				E3	
RGB		15.4	198	14	15-E032 - 00
				34	
				54	
				60	
				DL	
				E3	
24VDC					

15-E031	IP	ON-OFF	u. min	u. max		Code
				110-127V	220-240V	
	IP68	ON-OFF	1	1	1	71-E101-05-05
		ON-OFF	1	12	14	71-6345-00-00
	IP20	DALI	1	7	7	71-E099-00-00
		0-10V	1	7	7	71-E097-00-00
	Optional IP66 IK09 box (300x200x105mm)					71-E100-00-00

① P. 946

Smart Compatible-Zub. / Access. Smart Compatibile
71-8050-00-00 Dimmer Casambi PWM 4ch IP20
71-A242-00-00 Driver Casambi PWM 1ch IP66

mitgeliefertes allgemeines Zub. Platten zur Erleichterung der verketteten Montage
Access. comuni inclusi Piastre per facilitare l'installazione concatenata

nicht mitgeliefertes allgemeines Zub. Access. comuni non inclusi		
5-m-Kabel mit wasserdichten Schnellsteckverbindern Cavo da 5m con connettori rapidi a tenuta stagna		71-E004-00-00
1-m-Kabel mit wasserdichten Schnellsteckverbindern Cavo da 1m con connettori rapidi a tenuta stagna		71-E034-00-00
IP68- Antikondensationsstecker mit 2 Eingängen Connettore IP68 con valvola anticondensa a 2 ingressi		71-E112-00-00
IP68- Antikondensationsstecker mit 4 Eingängen Connettore IP68 con valvola anticondensa a 4 ingressi		71-E122-00-00
Verlängerungsarm dunkelgrau 70mm Tiefe. Braccio dilatatore grigio scuro da 70 mm di profondità.		71-E359-Z5-00
Verlängerungsarm dunkelgrau 140mm Tiefe. Braccio dilatatore grigio scuro da 140 mm di profondità.		71-E360-Z5-00

*Fragen Sie unser Verkaufsteam nach den Lieferbedingungen.
Consultare i termini e le condizioni di consegna al nostro team commerciale.

TAGLIO

Taglio Opal Recessed

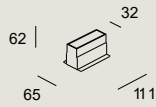

111x65

NEW	DIF MAT	IP	IK			0.15 m		SEA SIDE	PWM	(SC)
	PMMA	65/67	10					SUITABLE		

M3

LED				
K	CRI	W LED	Real Lm	Code
3000	80	1.2	65	55-E039 - M3 - CL
4000	80	1.2	65	55-E039 - M3 - CM
RGB		1.2	19	55-E040 - M3 - 00

24VDC

55-E039	IP		u. min	u. max	Code
	IP68	ON-OFF		1	16
		ON-OFF	1	20	71-E158-00-00
IP67	DALI		1	30	71-E098-00-00
	0-10V		1	30	71-E094-00-00
	Optional IP66 IK09 box (300x200x105mm)				71-E100-00-00

P. 946

Smart Compatible-Zub. / Access. Smart Compatibile
71-8050-00-00 Dimmer Casambi PWM 4ch IP20
71-A242-00-00 Driver Casambi PWM 1ch IP66

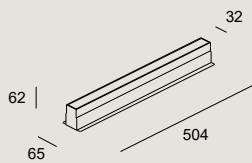

504x65

NEW	DIF MAT	IP	IK			0.15 m		SEA SIDE	(SC)
	PMMA	65/67	06					SUITABLE	

M3

LED				
K	CRI	W LED	Real Lm	Code
3000	80	7.7	412	55-E042 - M3 - CL
4000	80	7.7	412	55-E042 - M3 - CM
RGB		8.4	99	55-E043 - M3 - 00

24VDC

55-E042	IP		u. min	u. max	Code
	IP68	ON-OFF		1	2
		ON-OFF	1	7	71-E159-00-00
IP67	DALI		1	7	71-E098-00-00
	0-10V		1	7	71-E096-00-00
	Optional IP66 IK09 box (300x200x105mm)				71-E100-00-00

P. 946

Smart Compatible-Zub. / Access. Smart Compatibile
71-8050-00-00 Dimmer Casambi PWM 4ch IP20
71-A242-00-00 Driver Casambi PWM 1ch IP66

TAGLIO

Taglio Opal Recessed

DIF MAT	IP	IK					SEA SIDE SUITABLE	BREEAM		
PMMA	65/67	06			0.15 m				PWM	

M3

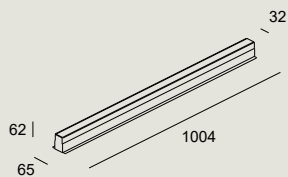

LED					
K	CRI	W LED	Real Lm	Code	
3000	80	14.7	1407	55-E004 - M3 - CL	
4000	80	14.7	1407	55-E004 - M3 - CM	
RGB		15.4	800	55-E005 - M3 - 00	

24VDC

55-E004	IP		u. min	u. max		Code
				110-127V	220-240V	
	IP68	ON-OFF	1	1	1	71-E101-05-05
		ON-OFF	1	12	14	71-6345-00-00
	IP20	DALI	1	7	7	71-E099-00-00
		0-10V	1	7	7	71-E097-00-00
	Optional IP66 IK09 box (300x200x105mm)					71-E100-00-00

P. 946

Smart Compatible-Zub. / Access. Smart Compatibile
71-8050-00-00 Dimmer Casambi PWM 4ch IP20
71-A242-00-00 Driver Casambi PWM 1ch IP66

TAGLIO

Taglio Opal Recessed

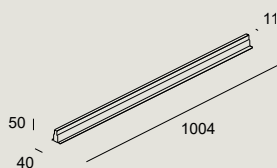

DIF MAT	IP	IK	3					SEA SIDE	BREEAM	(SC)
PMMA	65/67	10	MacAdam	1000 Kg		0.15 m		SUITABLE		



M3

LED					
K	CRI	W LED	Real Lm	Code	
3000	80	7.8	542	55-E076 - M3 - CL	
4000	80	7.8	542	55-E076 - M3 - CM	

24VDC

55-E076	IP		u. min	u. max	Code
	IP68	ON-OFF	1	2	71-E101-05-05
		ON-OFF	1	11	71-6341-00-00
IP67	DALI	1	14	71-E099-00-00	
	0-10V	1	14	71-E097-00-00	
	Optional IP66 IK09 box (300x200x105mm)			71-E100-00-00	

P. 946

Smart Compatible-Zub. / Access. Smart Compatibile
71-8050-00-00 Dimmer Casambi PWM 4ch IP20
71-A242-00-00 Driver Casambi PWM 1ch IP66

mitgeliefertes allgemeines Zub. Access. comuni inclusi

Platten zur Erleichterung der verketteten Montage
Piastrre per facilitare l'installazione concatenata

Unterputzdose
Cassetta da incasso

Wasserdichte Steckverbinder nach IP67
Connettori stagni IP67

Abdeckung zur Verhinderung des Eindringens von Putz oder Beton während der Installation
Coperchio per evitare l'ingresso di cemento durante l'installazione

nicht mitgeliefertes allgemeines Zub. Access. comuni non inclusi

5-m-Kabel mit wasserdichten Schnellsteckverbindern Cavo da 5m con connettori rapidi a tenuta stagna	71-E004-00-00
1-m-Kabel mit wasserdichten Schnellsteckverbindern Cavo da 1m con connettori rapidi a tenuta stagna	71-E034-00-00
IP68- Antikondensationsstecker mit 2 Eingängen Connettore IP68 con valvola anticondensa a 2 ingressi	71-E112-00-00
IP68- Antikondensationsstecker mit 4 Eingängen Connettore IP68 con valvola anticondensa a 4 ingressi	71-E122-00-00
Ausbausatz für das LED-Modul Kit di estrazione modulo LED	71-E362-Z5-00

TAGLIO

Taglio Optics Surface

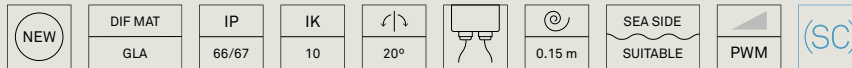
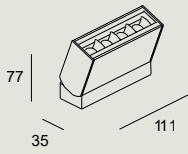

LED						
K	CRI	W LED	Real Lm	Optics	Code	
3000	80	4	249	Medium 23°	15-E025 - 14	- CL
					34	
					54	
					60	
					DL	
4000	80	4	249	Medium 23°	15-E025 - 60	- CM
					DL	
					E3	
					J6	
					Z5	
RGB		4	85	Medium 21°	15-E026 - 60	- 00
					DL	
					E3	
					J6	
					Z5	

24VDC

15-E026	IP	u. min	u. max	Code	
	IP68	ON-OFF	1	5	71-E101-05-05
		ON-OFF	1	14	71-E159-00-00
	IP67	DALI	1	14	71-E098-00-00
		0-10V	1	14	71-E096-00-00
	Optional IP66 IK09 box (300x200x105mm)			71-E100-00-00	

① P. 946

nicht inklusive / Non incluso	
5-m-Kabel mit wasserdichten Schnellsteckverbindern Cavo da 5m con connettori rapidi a tenuta stagna	71-E004-00-00
1-m-Kabel mit wasserdichten Schnellsteckverbindern Cavo da 1m con connettori rapidi a tenuta stagna	71-E034-00-00
IP68- Antikondensationsstecker mit 2 Eingängen Connettore IP68 con valvola anticondensa a 2 ingressi	71-E112-00-00
IP68- Antikondensationsstecker mit 4 Eingängen Connettore IP68 con valvola anticondensa a 4 ingressi	71-E122-00-00
Verlängerungsarm dunkelgrau 70mm Tiefe. Braccio dilatatore grigio scuro da 70 mm di profondità.	71-E359-Z5-00
Verlängerungsarm dunkelgrau 140mm Tiefe. Braccio dilatatore grigio scuro da 140 mm di profondità.	71-E360-Z5-00

Smart Compatible-Zub. / Access. Smart Compatibile	
71-8050-00-00 Dimmer Casambi PWM 4ch IP20	
71-A242-00-00 Driver Casambi PWM 1ch IP66	

*Fragen Sie unser Verkaufsteam nach den Lieferbedingungen.

Consultare i termini e le condizioni di consegna al nostro team commerciale.

TAGLIO

Taglio Optics Surface

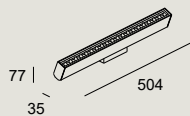

NEW	DIF MAT GLA	IP 66/67	IK 06	↕ 20°		0.15 m	SEA SIDE SUITABLE	PWM	
------------	----------------	-------------	----------	----------	--	--------	----------------------	-----	--

14* 34* 54 60* DL* E3* J6* Z5*

LED						
K	CRI	W LED	Real Lm	Optics	Code	
3000	80	19	1182	Medium 23°	15-E029 - 14	
					DL	CL
					E3	
					J6	
					Z5	
4000	80	19	1182	Medium 23°	15-E029 - 14	
					DL	CM
					E3	
					J6	
					Z5	
RGB		20	421	Medium 22°	15-E030 - 14	
					DL	00
					E3	
					J6	
					Z5	

24VDC

15-E029	IP		u. min	u. max		Code
				110-127V	220-240V	
IP68		ON-OFF	1	1	1	71-E101-05-05
					9	11
IP20		DALI	1	5	5	71-E099-00-00
					5	71-E097-00-00
Optional IP66 IK09 box (300x200x105mm)						71-E100-00-00

① P. 946

nicht inklusive / Non incluso	
5-m-Kabel mit wasserdichten Schnellsteckverbindern Cavo da 5m con connettori rapidi a tenuta stagna	71-E004-00-00
5-m-Kabel mit wasserdichten Schnellsteckverbindern RGB Cavo da 5m con connettori rapidi a tenuta stagna RGB	71-E005-00-00
1-m-Kabel mit wasserdichten Schnellsteckverbindern Cavo da 1m con connettori rapidi a tenuta stagna	71-E034-00-00
1-m-Kabel mit wasserdichten Schnellsteckverbindern RGB Cavo da 1m con connettori rapidi a tenuta stagna RGB	71-E071-00-00
IP68- Antikondensationsstecker mit 2 Eingängen Connettore IP68 con valvola anticondensa a 2 ingressi	71-E112-00-00
IP68- Antikondensationsstecker mit 4 Eingängen Connettore IP68 con valvola anticondensa a 4 ingressi	71-E122-00-00
Verlängerungsarm dunkelgrau 70mm Tiefe. Braccio dilatatore grigio scuro da 70 mm di profondità.	71-E359-Z5-00
Verlängerungsarm dunkelgrau 140mm Tiefe. Braccio dilatatore grigio scuro da 140 mm di profondità.	71-E360-Z5-00

Smart Compatible-Zub. / Access. Smart Compatibile
71-8050-00-00 Dimmer Casambi PWM 4ch IP20
71-A242-00-00 Driver Casambi PWM 1ch IP66

*Fragen Sie unser Verkaufsteam nach den Lieferbedingungen.

Consultare i termini e le condizioni di consegna al nostro team commerciale.

TAGLIO

Taglio Optics Surface



14* ○ 34* ● 54 ○ 60* ● DL* ● E3* ● J6* ● Z5* ●

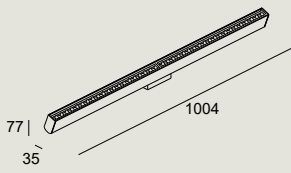

LED						
K	CRI	W LED	Real Lm	Optics	Code	
3000	80	38	2364	Medium 23°	15-E033 - 14	- CL
					34	
					54	
					60	
					DL	
4000	80	38	2364	Medium 23°	15-E033 - 60	- CM
					DL	
					E3	
					J6	
					Z5	
RGB		40	842	Medium 22°	15-E034 - 60	- 00
					DL	
					E3	
					J6	
					Z5	

24VDC

15-E033	IP	u. min	u. max		Code
			220-240V	110-127V	
	ON-OFF	1	6	4	71-6345-00-00
	DALI	1	3	3	71-E099-00-00
	0-10V	1	3	3	71-E097-00-00
	Optional IP66 IK09 box (300x200x105mm)				71-E100-00-00

P. 946

nicht inklusive / Non incluso	
5-m-Kabel mit wasserdichten Schnellsteckverbindern Cavo da 5m con connettori rapidi a tenuta stagna	71-E004-00-00
5-m-Kabel mit wasserdichten Schnellsteckverbindern RGB Cavo da 5m con connettori rapidi a tenuta stagna RGB	71-E005-00-00
1-m-Kabel mit wasserdichten Schnellsteckverbindern Cavo da 1m con connettori rapidi a tenuta stagna	71-E034-00-00
1-m-Kabel mit wasserdichten Schnellsteckverbindern RGB Cavo da 1m con connettori rapidi a tenuta stagna RGB	71-E071-00-00
IP68- Antikondensationsstecker mit 2 Eingängen Connettore IP68 con valvola anticondensa a 2 ingressi	71-E112-00-00
IP68- Antikondensationsstecker mit 4 Eingängen Connettore IP68 con valvola anticondensa a 4 ingressi	71-E122-00-00

Smart Compatible-Zub. / Access. Smart Compatibile	
71-8050-00-00 Dimmer Casambi PWM 4ch IP20	
71-A242-00-00 Driver Casambi PWM 1ch IP66	

mitgeliefertes allgemeines Zub. Platten zur Erleichterung der verketteten Montage
Access. comuni inclusi Piastre per facilitare l'installazione concatenata

*Fragen Sie unser Verkaufsteam nach den Lieferbedingungen.
 Consultare i termini e le condizioni di consegna al nostro team commerciale.

TAGLIO

Taglio Optics Recessed

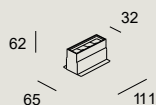

111x65

DIF MAT	IP	IK	1500 Kg		0.15 m			
GLA	65/67	10				SEA SIDE SUITABLE	PWM	

37

LED					
K	CRI	W LED	Real Lm	Optics	Code
RGB		4	85	Medium 21°	55-E041 - 37 - 00
3000	80	4	249	Medium 23°	55-E162 - 37 - CL
4000	80	4	261	Medium 23°	55-E162 - 37 - CM

24VDC

55-E162	IP		u. min	u. max	Code
	IP68	ON-OFF	1	5	71-E101-05-05
	ON-OFF	1	14	71-E159-00-00	
IP67	DALI	1	14	71-E098-00-00	
	0-10V	1	14	71-E096-00-00	
	Optional IP66 IK09 box (300x200x105mm)			71-E100-00-00	

P. 946

Smart Compatible-Zub. / Access. Smart Compatibile
71-8050-00-00 Dimmer Casambi PWM 4ch IP20
71-A242-00-00 Driver Casambi PWM 1ch IP66

DIF MAT	IP	IK	1500 Kg		0.15 m	
GLA	65/67	06				SEA SIDE SUITABLE

37

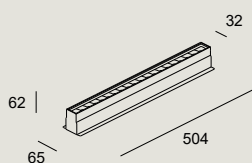

504x65

LED					
K	CRI	W LED	Real Lm	Optics	Code
3000	80	19	1088	Medium 23°	55-E163 - 37 - CL
4000	80	19	1140	Medium 23°	55-E163 - 37 - CM
RGB		20	421	Medium 22°	55-E050 - 37 - 00

24VDC

55-E163	IP		u. min	u. max		Code
				110-127V	220-240V	
IP68	ON-OFF	1	1	1	1	71-E101-05-05
	ON-OFF	1	9	11		71-6345-00-00
IP20	DALI	1	5	5		71-E099-00-00
	0-10V	1	5	5		71-E097-00-00
	Optional IP66 IK09 box (300x200x105mm)			71-E100-00-00		

P. 946

Smart Compatible-Zub. / Access. Smart Compatibile
71-8050-00-00 Dimmer Casambi PWM 4ch IP20
71-A242-00-00 Driver Casambi PWM 1ch IP66

TAGLIO

Taglio Optics Recessed



37

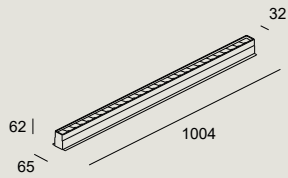

LED					
K	CRI	W LED	Real Lm	Optics	Code
3000	80	38	2364	Medium 23°	55-E051 - 37 - CL
4000	80	38	2364	Medium 23°	55-E051 - 37 - CM
RGB		40	842	Medium 22°	55-E052 - 37 - 00
24VDC					

55-E051	IP		u. min	u. max		Code
				220-240V	110-127V	
		ON-OFF	1	6	4	71-6345-00-00
	IP67	DALI	1	3	3	71-E099-00-00
		0-10V	1	3	3	71-E097-00-00
		Optional IP66 IK09 box (300x200x105mm)				71-E100-00-00

P. 946

Smart Compatible-Zub. / Access. Smart Compatibile	
71-8050-00-00	Dimmer Casambi PWM 4ch IP20
71-A242-00-00	Driver Casambi PWM 1ch IP66

mitgeliefertes allgemeines Zub. Access. comuni inclusi	Platten zur Erleichterung der verketteten Montage Piastrre per facilitare l'installazione concatenata	
	Unterputzdose Cassetta da incasso	
	Unterputzdose Cassetta da incasso	
	Wasserdichte Steckverbinder nach IP67 Connettori stagni IP67	
	Abdeckung zur Verhinderung des Eindringens von Putz oder Beton während der Installation Coperchio per evitare l'ingresso di cemento durante l'installazione	
nicht mitgeliefertes allgemeines Zub. Access. comuni non inclusi	5-m-Kabel mit wasserdichten Schnellsteckverbindern Cavo da 5m con connettori rapidi a tenuta stagna	71-E004-00-00
	1-m-Kabel mit wasserdichten Schnellsteckverbindern Cavo da 1m con connettori rapidi a tenuta stagna	71-E034-00-00
	IP68- Antikondensationsstecker mit 2 Eingängen Connettore IP68 con valvola anticondensa a 2 ingressi	71-E112-00-00
	IP68- Antikondensationsstecker mit 4 Eingängen Connettore IP68 con valvola anticondensa a 4 ingressi	71-E122-00-00
	Ausbausatz für das LED-Modul bei Defekt. Kit di estrazione del modulo LED in caso di guasto.	71-E362-Z5-00

TAGLIO

Taglio Indirect

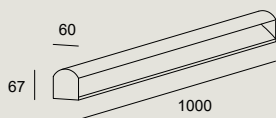

DIF MAT	IP	IK			SEA SIDE		
PMMA	66/67	10		0.15 m	SUITABLE	PWM	(SC)

54

LED				
K	CRI	W LED	Real Lm	Code
3000	80	9.6	184	55-E034 - 54 - CL
4000	80	9.6	184	55-E034 - 54 - CM
RGB		9.6	138	55-E071 - 54 - 00

24VDC

55-E034	IP		u. min	u. max	Code
	IP68	ON-OFF	1	2	71-E101-05-05
		ON-OFF	1	9	71-6341-00-00
	IP67	DALI	1	11	71-E099-00-00
		0-10V	1	11	71-E097-00-00
	Optional IP66 IK09 box (300x200x105mm)				71-E100-00-00

P. 946

inklusive / Incluso
Wasserdichtes Kabel Cavo impermeabile
Platten zur Erleichterung der verketteten Montage Piastre per facilitare l'installazione concatenata
Wasserdichte Steckverbinder nach IP67 Connettori stagni IP67

nicht inklusive / Non incluso	
5-m-Kabel mit wasserdichten Schnellsteckverbindern Cavo da 5m con connettori rapidi a tenuta stagna	71-E004-00-00
5-m-Kabel mit wasserdichten Schnellsteckverbindern RGB Cavo da 5m con connettori rapidi a tenuta stagna RGB	71-E005-00-00
1-m-Kabel mit wasserdichten Schnellsteckverbindern Cavo da 1m con connettori rapidi a tenuta stagna	71-E034-00-00
1-m-Kabel mit wasserdichten Schnellsteckverbindern RGB Cavo da 1m con connettori rapidi a tenuta stagna RGB	71-E071-00-00
IP68- Antikondensationsstecker mit 2 Eingängen Connettore IP68 con valvola anticondensa a 2 ingressi	71-E112-00-00
IP68- Antikondensationsstecker mit 4 Eingängen Connettore IP68 con valvola anticondensa a 4 ingressi	71-E122-00-00

Smart Compatible-Zub. / Access. Smart Compatibile
71-8050-00-00 Dimmer Casambi PWM 4ch IP20
71-A242-00-00 Driver Casambi PWM 1ch IP66



Convert

Convert Surface



356 mm



984 mm

11 - 34,5 W
41° x 13°



54 ○

Convert Recessed



330 mm



1000 mm

12,2 - 45 W
43° x 16°



34 ○

CONVERT

BODY MAT	DIF MAT		50000h	3
AL	GLA		L80 B20	MacAdam



Eine Kollektion mit kleinen und kompakten, geradlinigen Leuchten, die eine perfekte Ausleuchtung großer vertikaler Oberflächen ermöglichen. Convert hat den großen Vorteil, dass der Treiber in die Leuchten eingebaut ist. Dadurch wird die Installation erleichtert. Die Kollektion ist für Auf- und Unterputzeinbau sowie mit verschiedenen Farbtemperaturen und Baulängen erhältlich.

Collezione di apparecchi lineari piccoli e compatti che assicurano il perfetto wallwasher di qualsiasi grande superficie lineare. Convert ha il grande vantaggio di avere il driver all'interno delle luci, semplificando così l'installazione, ed è disponibile sia in versione da incasso che in versione da superficie, entrambe con varie temperature di colore e lunghezze.

Garantierte Einheitlichkeit Uniformità garantita

Dank der strategischen Anordnung der LED und der Verwendung von elliptischen Optiken kann ein absolut gleichmäßiges Licht erzeugt werden, das speziell für die Beleuchtung von Wänden und Fassaden entwickelt wurde. Mit der RGB White-Version lassen sich Farben einbinden und über DMX steuern, um die kreativen Anforderungen jedes Projekts zu erfüllen.

Grazie al posizionamento strategico dei LED e all'incorporazione di ottiche ellittiche, è possibile proiettare un'illuminazione completamente uniforme, studiata appositamente per bagnare pareti e facciate. La versione RGB White consente di incorporare i colori e di controllarli tramite DMX per adattarsi alla creatività di ogni progetto.

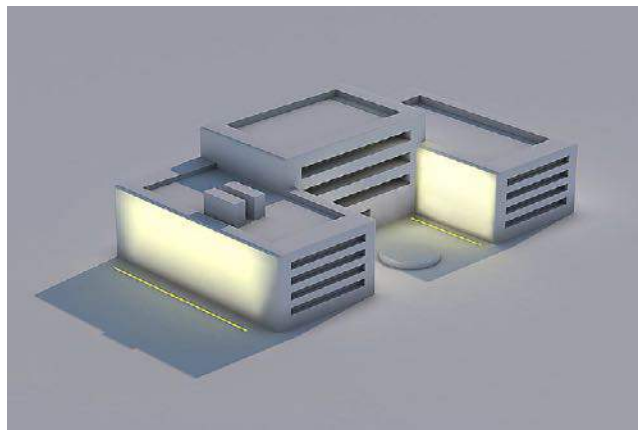

Homogene Wandbeleuchtung Wallwasher omogeneo

Convert Recessed bietet eine einheitliche und effiziente Wandbeleuchtung, da die optische Einheit leicht zur Wand hin ausgerichtet ist.

Convert Recessed offre un wallwasher omogeneo ed efficiente grazie al fatto che il gruppo ottico è leggermente orientato verso la parete.

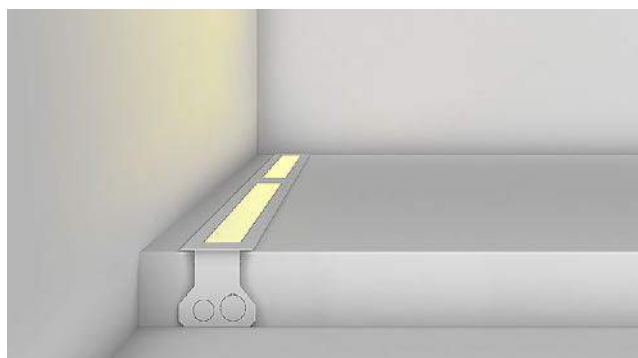
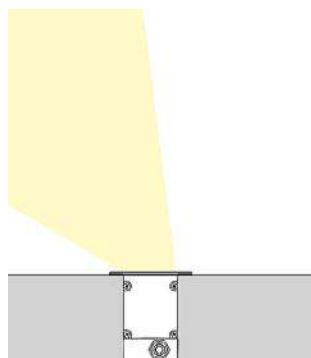

Einfache Installation Installazione facile

Bei Convert ist der Treiber in der Leuchte verbaut, sodass die Installation wesentlich einfacher und schneller erfolgt. Verfügt außerdem über einen doppelten Kabelausgang, um die Installation in Reihe zu vereinfachen.

Convert include il driver all'interno dell'apparecchio di illuminazione, permettendo che la sua installazione sia molto più semplice e veloce. Dispone inoltre di una doppia uscita del cavo per facilitare l'installazione in serie.

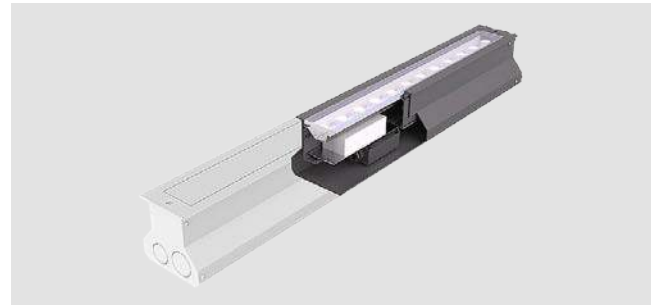

Einbausatz Kit di installazione

Convert Recessed enthält einen Einbausatz für Ketten- und Endlosinstallation.

Convert Recessed include un kit di installazione a catena ed infinita.



Smart-Funktionen: Farbmanagement Funzionalità Smart: Gestione del colore

Die RGBW-DMX-Versionen von Convert ermöglichen zusammen mit dem entsprechenden Smart-Zubehör die Umsetzung von Funktionen wie die Einstellung von verschiedenen Farben an bestimmten Feiertagen des Jahres.

Le versioni RGBW DMX di Convert, insieme al relativo accessorio Smart, consentono di realizzare una grande varietà di operazioni come la configurazione di determinati colori in base alla festività indicata in calendario.

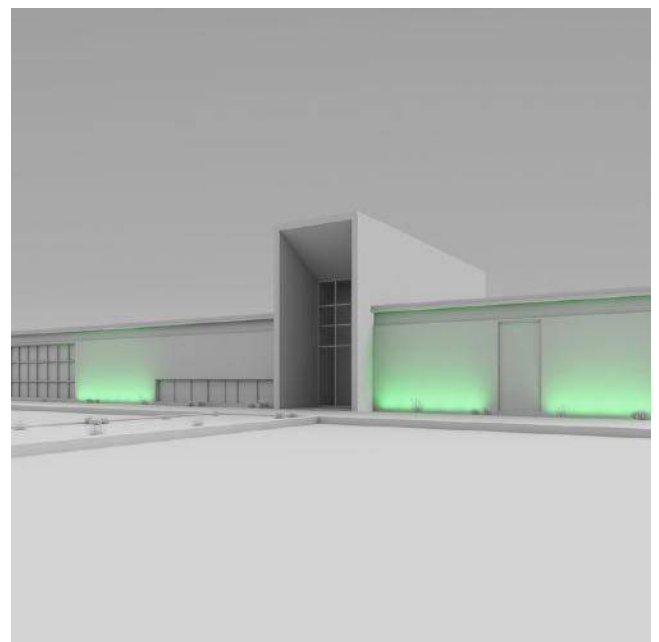

CONVERT

Convert Surface

IP	IK			SEA SIDE		BREEAM
66	03	±90°		SUITABLE	ON-OFF	

54

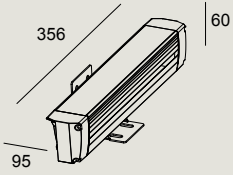

LED						
K	CRI	W LED	W Total	Real Lm	Optics	Code
3000	80	11	12.9	1170	Eliptic 41° x 13°	05-9749 - 54 - CL
4000	80	11	12.9	1228	Eliptic 41° x 13°	05-9749 - 54 - CM
		100-240V 50-60Hz				

IP	IK			SEA SIDE	
66	03	±90°		SUITABLE	

54

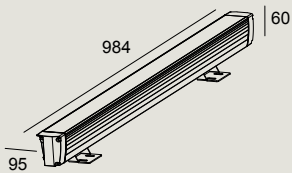

LED						
K	CRI	W LED	W Total	Real Lm	Optics	Code
3000	80	34.5	36.5	2909	Eliptic 41° x 13°	05-9750 - 54 - CL
4000	80	34.5	36.5	3055	Eliptic 41° x 13°	05-9750 - 54 - CM
RGBW DMX	80	45	50	2073	Eliptic 41° x 13°	05-E100 - 54 - 00
		05-9750 ON-OFF 100-240V 50-60Hz				
		05-E100 DMX 100-240V 50-60Hz				

Smart Compatible-Zub. / Access. Smart Compatibile
71-A238-00-00 Converter Casambi DMX IP66

nicht mitgeliefertes
allgemeines Zub.
Access. comuni non inclusi

Befestigungsarme, Länge 307 mm
Bracci fissi, di 307mm di lunghezza

71-E155-CA-CA

CONVERT

Convert Recessed

NEW	IP 65/67	IK 10	250 Kg			SEA SIDE SUITABLE	ON-OFF	BREEM
-----	-------------	----------	--------	--	--	----------------------	--------	-------

34

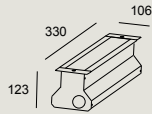

317x133

LED						
K	CRI	W LED	W Total	Real Lm	Optics	Code
3000	80	12.2	15.6	1261	Eliptic 43° x 19°	55-E074 - 34 - CL
4000	80	12.2	15.6	1261	Eliptic 43° x 19°	55-E074 - 34 - CM

IK 10	IP 65/67	250 Kg			SEA SIDE SUITABLE	(SC)
----------	-------------	--------	--	--	----------------------	------

34

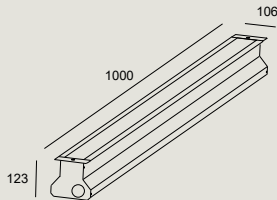

987x133

LED						
K	CRI	W LED	W Total	Real Lm	Optics	Code
3000	80	40.7	45.7	3522	Eliptic 43° x 16°	55-9958 - 34 - CL
4000	80	40.7	45.7	3522	Eliptic 43° x 16°	55-9958 - 34 - CM
RGBW DMX	80	45	50	2073	Eliptic 43° x 16°	55-E101 - 34 - 00
	55-9958	0-10V	100-240V	50-60Hz		
	55-E101	DMX	100-240V	50-60Hz		

Smart Compatible-Zub. / Access. Smart Compatibile

71-A238-00-00 Converter Casambi DMX IP66

mitgeliefertes allgemeines Zub.
Access. comuni inclusi

Zubehör zur Erleichterung der Verkettung von Unterputzdosen
Accessorio per agevolare la concatenazione di scatole da incasso

Unterputzdose
Cassetta da incasso

Tron

BODY MAT	DIF MAT		50000h	3
AL	GLA		L80 B20	MacAdam

Eine Kollektion von Wandleuchten in linearem Format, die besonders dafür entworfen wurde, einen eleganten und perfekten Verlauf auf vertikalen Architekturflächen zu erzielen. Sie kann mittels einfach zu installierender Steckverbinder in Reihe geschaltet werden, wobei verschiedene Leuchten unter Einhaltung des Abstands zwischen den LED-Lichtern miteinander verkettet werden können. Dank seiner 180°-Ausrichtung bietet Tron eine perfekte Lichtverteilung, die eine gleichmäßige und ungeteilte Ausleuchtung ermöglicht.

Collezione di wallwasher in formato lineare studiata appositamente per ottenere sfumature eleganti e perfette, su superfici architettoniche verticali. Può essere installato in serie con connettori di facile installazione concatenandone diversi apparecchi curando l'interdistanza luminosa dei LED. Tron offre un fascio perfetto, grazie al suo orientamento a 180° che permette una luce omogenea e senza tagli.

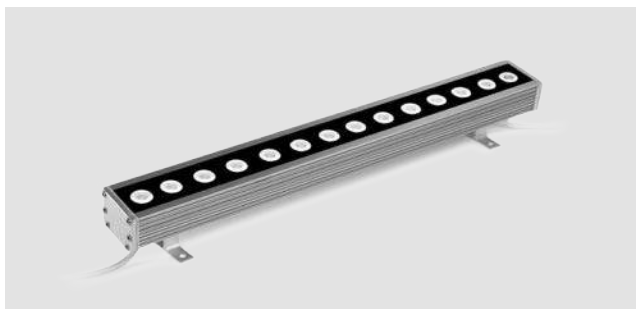

Elliptische Optiken Ottiche ellittiche

Dank der strategischen Anordnung der LED und der Verwendung von elliptischen Optiken kann ein gleichmäßiges Licht erzeugt werden, das speziell für die Beleuchtung von Wänden und Fassaden entwickelt wurde.

Grazie al posizionamento strategico dei LED e all'incorporazione di ottiche ellittiche, è possibile proiettare un'illuminazione uniforme, studiata appositamente per bagnare pareti e facciate.

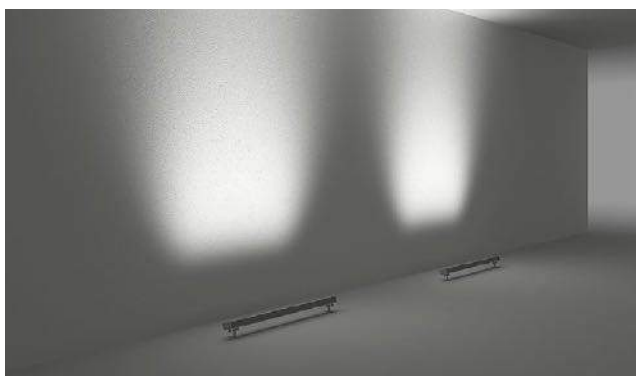

RGB-Version Versione RGB

Die RGB-Version verleiht dem Projekt Vielseitigkeit, womit es an die kreativen Anforderungen angepasst werden kann.

La versione RGB offre versatilità al progetto e può quindi essere adattata alle esigenze della creatività.

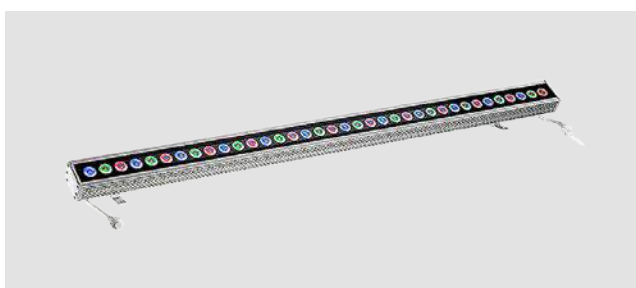

Wall-Washer-Effekt Effetto Wall washer

Die Tron-Kollektion eignet sich ideal für die Beleuchtung großer vertikaler Flächen, sowohl in der Standard- als auch in der RGB-Version.

La collezione Tron è ideale per bagnare grandi superfici verticali, sia in versione standard che in RGB.

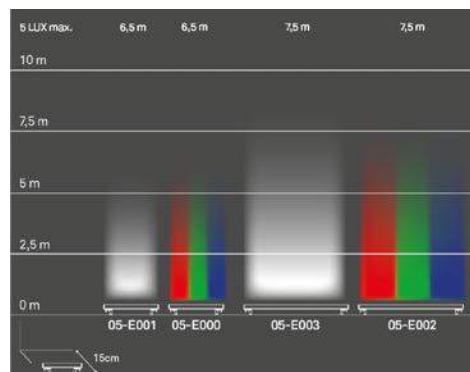

Externer Treiber Driver remoto

Einige Wandleuchten werden in schwer zugänglichen Bereichen eingebaut. Ein externer Treiber ist daher wichtig, da im Falle einer Störung der Zugang schneller und kostengünstiger ist. Muss das Projekt zudem steuerbar sein, kann ein dimmbarer Treiber gewählt werden, der den Anforderungen der Leuchte und der Umgebung entspricht.

Alcuni wallwasher vengono installati in spazi di difficile accesso ed è, pertanto, importante disporre di un driver remoto, poiché in caso di guasto l'accesso è più veloce ed ha un costo inferiore. Inoltre, se il progetto richiede la regolazione, è possibile selezionare un driver dimmerabile in base alle esigenze dell'apparecchio di illuminazione e dell'ambiente.

Smart-Funktionen: Farbmanagement Funzionalità Smart: Gestione del colore

Die RGB-Versionen von Tron ermöglichen zusammen mit dem entsprechenden Smart-Zubehör eine Farbeinstellung, die exakt auf das Kommunikationsziel oder die Marketingaktion abgestimmt ist und verleihen dem Raum so zusätzliche Flexibilität.

Le versioni RGB di Tron, con il relativo accessorio Smart, consentono di configurare i colori in base all'obiettivo della comunicazione o della campagna di Marketing, dotando lo spazio di una funzionalità aggiuntiva.



Maximale Lebensdauer Massima durabilità

Die Leuchte besteht aus einem Gehäuse aus eloxiertem Aluminium, das die Lebensdauer des Produkts maximiert und seine Installation in nassen Umgebungen oder sogar direkt am Meer ermöglicht.

La sua struttura è composta da un corpo in alluminio anodizzato per massimizzare la vita utile del prodotto, che ne consente l'installazione anche in ambienti umidi o sul lungomare.

IP	IK			SEA SIDE SUITABLE		
66	05	±90°			PWM	

54

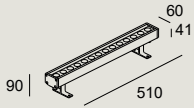

LED						
K	CRI	W LED	W Total	Real Lm	Optics	Code
3000	80	24	24	2459	Medium 23°	05-E001 - 54 - CL
4000	80	24	24	2622	Medium 23°	05-E001 - 54 - CM
RGB		29.2	29.2	1352	Medium 21°	05-E000 - 54 - 37

24VDC

05-E001	IP		u. min	u. max		Code
				110-127V	220-240V	
		ON-OFF	1	7	10	71-6345-00-00
	IP67	DALI	1	5	5	71-E099-00-00
		0-10V	1	5	5	71-E097-00-00
		Optional IP66 IK09 box (300x200x105mm)				71-E100-00-00

P. 946

nicht inklusive / Non incluso	
IP68-Stecker mit 6 Eingängen Connettore IP68 a 6 ingressi	71-9199-05-05
IP67-Stecker mit 3 Eingängen Connettore IP67 a 3 ingressi	71-9262-05-05
1-m-Kabel mit wasserdichten Schnellsteckverbindern Cavo da 1m con connettori rapidi a tenuta stagna	71-E000-00-00
1-m-Kabel mit wasserdichten Schnellsteckverbindern Cavo da 1m con connettori rapidi a tenuta stagna	71-E001-00-00
IP68- Antikondensationsstecker mit 2 Eingängen Connettore IP68 con valvola anticondensa a 2 ingressi	71-E112-00-00
IP68- Antikondensationsstecker mit 4 Eingängen Connettore IP68 con valvola anticondensa a 4 ingressi	71-E122-00-00
Befestigungsarme, Länge 307 mm Bracci fissi, di 307mm di lunghezza	71-E155-CA-CA

Smart Compatible-Zub. / Access. Smart Compatibile
71-8050-00-00 Dimmer Casambi PWM 4ch IP20
71-A242-00-00 Driver Casambi PWM 1ch IP66

TRON

IP 66	IK 05	 ±90°		SEA SIDE SUITABLE	 PWM	 (SC)
----------	----------	--	---	----------------------	--	--

54 

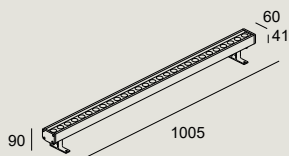

LED						
K	CRI	W LED	W Total	Real Lm	Optics	Code
3000	80	48	48	4918	Medium 23°	05-E003 - 54 - CL
4000	80	48	48	5244	Medium 23°	05-E003 - 54 - CM
RGB		55.9	55.9	2496	Medium 21°	05-E002 - 54 - 37

 24VDC

05-E003	IP		u. min	u. max		Code
				110-127V	220-240V	
		ON-OFF	1	3	5	71-6345-00-00
	IP67	DALI	1	2	2	71-E099-00-00
		0-10V	1	2	2	71-E097-00-00
		Optional IP66 IK09 box (300x200x105mm)				71-E100-00-00

 P. 946

nicht inklusive / Non incluso	
IP68-Stecker mit 6 Eingängen Connettore IP68 a 6 ingressi	71-9199-05-05
IP67-Stecker mit 3 Eingängen Connettore IP67 a 3 ingressi	71-9262-05-05
1-m-Kabel mit wasserdichten Schnellsteckverbindern Cavo da 1m con connettori rapidi a tenuta stagna	71-E000-00-00
1-m-Kabel mit wasserdichten Schnellsteckverbindern Cavo da 1m con connettori rapidi a tenuta stagna	71-E001-00-00
IP68- Antikondensationsstecker mit 2 Eingängen Connettore IP68 con valvola anticondensa a 2 ingressi	71-E112-00-00
IP68- Antikondensationsstecker mit 4 Eingängen Connettore IP68 con valvola anticondensa a 4 ingressi	71-E122-00-00
Befestigungsarme, Länge 307 mm Bracci fissi, di 307mm di lunghezza	71-E155-CA-CA

Smart Compatible-Zub. / Access. Smart Compatibile	
71-8050-00-00 Dimmer Casambi PWM 4ch IP20	
71-A242-00-00 Driver Casambi PWM 1ch IP66	



Afrodita

BODY MAT	DIF MAT		50000h	3
AL	GLA		L80 B20	MacAdam



Hoher visueller Komfort
Elevato comfort visivo

Afrodita Infinite bewahrt die Essenz der Kollektion Afrodita und stellt eine Weiterentwicklung und Ergänzung dieser Kategorie in Bezug auf in die Architektur integrierte Leuchten dar. Diese rechteckigen und schmalen Leuchten können aneinandergereiht werden, um einen Effekt von Unendlichkeit zu erzeugen. Außerdem erlauben sie die Modulation des Lichts durch Auswahl eines Einfach- oder Doppelstrahlers mit dem gleichen oder doppelten Lichtausstoß sowie die Anpassung der Lichtintensität dank der integrierten Bluetooth-Mesh-Technologie. Das minimalistische und leicht integrierbare Design ist ideal für die Beleuchtung und Betonung von Eingangsbereichen oder Fassaden von Hotels und Wohngebäuden.

Mantenendo l'essenza della collezione Afrodita, Afrodita Infinite rappresenta un'evoluzione ed un'espansione della sua categoria verso apparecchi di illuminazione integrati nell'architettura. Con forma rettangolare e stretta, questo modello lineare può essere installato in serie per offrire un effetto infinito. Consente inoltre di modulare la luce scegliendo doppia o mono emissione, con lo stesso flusso luminoso o doppio, e di regolare l'intensità grazie alla sua tecnologia integrata Bluetooth Mesh. Grazie al suo design minimalista ed integrato, è progettato per illuminare ed enfatizzare aree di ingresso o facciate di hotel e residenze.

Die Kollektion beinhaltet voneinander unabhängig schwenkbare LED-Module, die einen hohen visuellen Komfort gewährleisten und jede Wand gleichmäßig beleuchten.

La collezione dispone di moduli LED che si inclinano in modo indipendente per garantire un elevato comfort visivo e bagnare omogeneamente qualsiasi parete.



Uni- und bidirektionaler Lichtaustritt Mono o doppia emissione

Die Leuchte bietet die Möglichkeit, das Licht uni- oder bidirektionaler Strahlung mit der gleichen oder doppelten Lichtintensität auszurichten.

L'apparecchio offre la possibilità di orientare l'emissione luminosa in doppia o mono emissione, con lo stesso flusso luminoso o doppio.

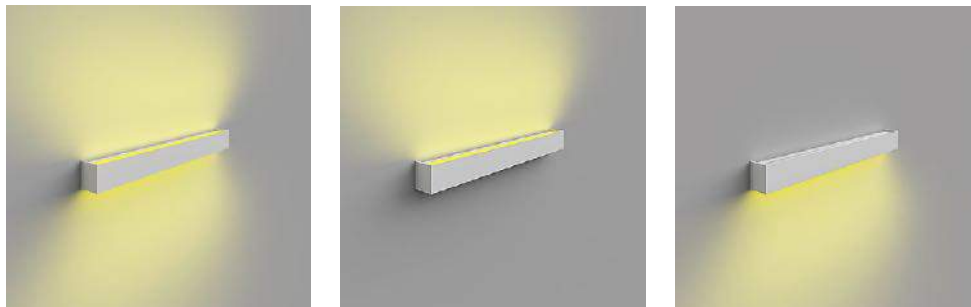

Smart

Afrodita Infinite ist in Ausführungen mit eingebauter Bluetooth Mesh-Casambi-Technologie erhältlich, mit der Räume vielseitiger gestaltet werden können, da das Einschalten und die Lichtintensität gesteuert werden können.

Afrodita Infinite è dotato di versioni con tecnologia Bluetooth Mesh Casambi integrata, che aumenta la versatilità degli spazi grazie alla possibilità di controllare l'accensione ed il flusso luminoso.

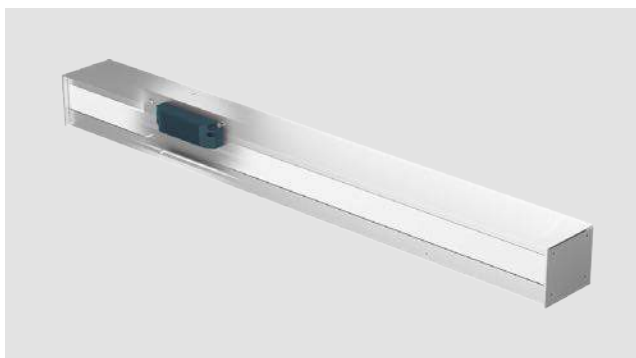

**Smart-Funktionen:
Energieeinsparung
Funzionalità Smart: Risparmio
energetico**

Die Smart-Technologie ermöglicht es unter anderem, die Leuchten entsprechend der Anwesenheit von Personen zu steuern und so unnötigen Energieverbrauch zu vermeiden, indem die Leuchte ausgeschaltet oder gedimmt werden kann.

Una delle funzionalità della tecnologia Smart consiste nel controllo delle luci in funzione della presenza, aiutando così a ridurre il consumo energetico non necessario grazie allo spegnimento o alla regolazione della luce.



Mit Anwesenheitssensor
Con presenza



Ohne Anwesenheitssensor
Senza presenza

Maximale Widerstandsfähigkeit Massima durabilità

Mit Gehäuse aus Aluminium mit speziellem, vor dem Lackieren aufgetragenen Rostschutz, um die Lebensdauer des Produkts zu maximieren und die Installation in nassen Umgebungen oder sogar direkt am Meer zu ermöglichen. Verfügt außerdem über eine spezielle Entfeuchtungsvorrichtung.

Dotato di un corpo in alluminio con speciale protezione contro la ruggine, prima della verniciatura, per massimizzare la vita utile del prodotto, potendo essere installato in ambienti umidi o anche sul lungomare. Dispone, inoltre, di uno speciale dispositivo di drenaggio.

Installationsoptionen Opzioni di installazione

Afrodita Infinite bietet zahlreiche Installations- und Wahlmöglichkeiten hinsichtlich der Steuerung der Lichtintensität. Es werden fünf verschiedene Versionen im Rahmen derselben Produktreferenz angeboten. Kann zudem schnell und einfach in verketteter Form installiert werden.

Afrodita Infinite è un pezzo con molte possibilità di installazione e di scelta nella regolazione del flusso luminoso. Offre fino a 5 diverse versioni dello stesso codice di riferimento. Può anche essere installato in serie in modo agile e semplice.

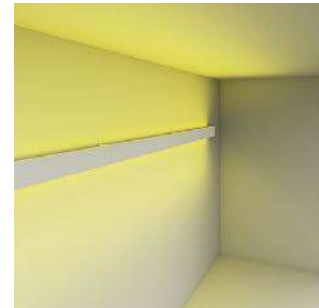
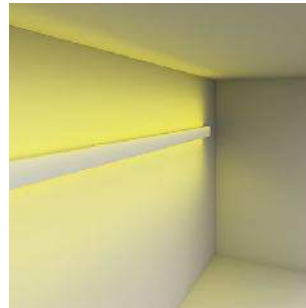

1. Einbauleuchte mit Doppelstrahler zur Beleuchtung der Wand nach oben und unten (Standardkonfiguration).

1. Applique a doppia emissione wall washer a parete verso l'alto e il basso (configurazione standard).

2. Einbauleuchte mit Doppelstrahler zur Beleuchtung der Decke nach oben und der Wand nach unten.

2. Applique a doppia emissione wall washer a soffitto verso l'alto e wall washer a parete verso il basso.

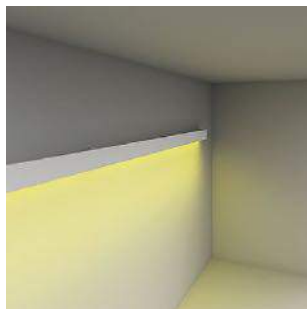

3. Einbauleuchte mit Einfachstrahler zur Beleuchtung der Wand ausschließlich nach unten (halbe Leistung).

3. Applique mono emissione wall washer solo verso il basso (metà potenza).



4. Einbauleuchte mit Einfachstrahler zur Beleuchtung der Wand ausschließlich nach oben (halbe Leistung).

4. Applique mono emissione wall washer solo verso l'alto (metà potenza).





5. Einbauleuchte mit Einfachstrahler zur Beleuchtung von Decke und Wand ausschließlich nach oben. orm installiert werden.

5. Applique mono emissione wall washer a soffitto e a parete, solo verso l'alto.

AFRODITA



Afrodita Infinite

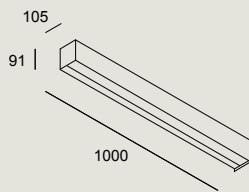

14  Z5 



LED						
K	CRI	W LED	W Total	Real Lm	Optics	Code
3000	80	20.3	24.8	1388	Flood 90°	05-E084 - 14 - CL
3000	80	29	32.5	2083	Flood 90°	05-E052 - Z5 - CL
3000	80	29	32.5	2083	Flood 90°	05-E086 - 14 - CL
4000	80	20.3	24.8	1388	Flood 90°	05-E084 - 14 - CM
4000	80	29	32.5	2166	Flood 90°	05-E086 - Z5 - CM

	05-E052	DALI-2	100-240V	50-60Hz
	05-E084	0-10V	100-240V	50-60Hz
	05-E086	Casambi	220-240V	50-60Hz



Mex

BODY MAT	DIF MAT		50000h
AL	GLA		L80 B20



Beleuchtung von niedrigen Wänden
Illuminazione di pareti di altezza ridotta

Höchste Langlebigkeit und Widerstandsfähigkeit
Massima durabilità e resistenza

Mex ist eine Kollektion von Wandleuchten zur Beleuchtung niedriger vertikaler Flächen, wie z. B. einer eingeschossigen Außenwand. Sie besticht durch eine einheitliche Beleuchtung mit hohem visuellem Komfort, dank der geneigten und strategisch angeordneten Position der LED und der indirekten Lichtprojektion, die das „Dark Light“-Konzept hervorhebt. Die Kollektion ist in den beiden Größen 33 und 100 cm sowie in einer Auf- und Unterputzversion erhältlich. Sie umfasst Ausführungen mit weißem Licht mit CCT-Technologie, bei der mithilfe eines integrierten Schalters die Farbtemperatur gewählt werden kann, oder auch RGBW-Ausführungen.

Mex è una collezione di wallwasher progettata per illuminare superfici verticali basse, come una facciata di un solo piano. Si distingue per offrire un'illuminazione omogenea con un grande comfort visivo, grazie a dei LED posizionati ed inclinati in forma strategica e alla proiezione indiretta della luce, massimizzando così il concetto di "Dark Light". La collezione è presentata in due dimensioni, 33 e 100 cm, ed in versione da superficie e da incasso. Offre versioni con luce bianca integrando la tecnologia CCT, con la quale, tramite uno switch integrato, è possibile scegliere la temperatura di colore o le versioni RGBW.

Perfekte Wandbeleuchtung für bis zu 2,7 m (ca. 1 Stockwerk) hohe Wände. Die perfekte Lösung für Einkaufszentren, Hotels oder Wohnhäuser, bei denen niedrige vertikale Flächen beleuchtet werden sollen.

Effetto wallwasher perfetto per illuminare pareti di 2,7 m o l'equivalente all'altezza di un pavimento. Soluzione perfetta per centri commerciali, hotel o residenze che sono alla ricerca di illuminare superfici verticali ridotte.

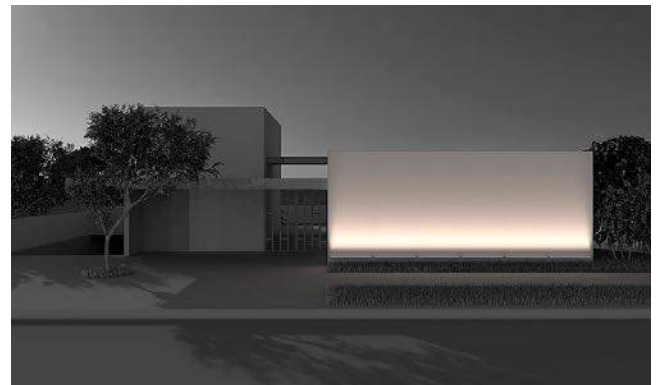

Mit einem Gehäuse aus extrudiertem Aluminium und einem Glasdiffusor, die die Lebensdauer des Produkts maximieren und seine Installation in nassen Umgebungen oder sogar direkt am Meer ermöglichen. Es verfügt außerdem über einen doppelten Kabelausgang und Schnellsteckverbinder, um die Installation in Reihe zu vereinfachen.

Dotato di un corpo in alluminio estruso e un diffusore in vetro per massimizzare la vita utile del prodotto e può essere installato in ambienti umidi o anche sul lungomare. Dispone inoltre di una doppia uscita del cavo e connettori rapidi per facilitare l'installazione in serie.



CCT-Technologie Tecnologia CCT

Bei den Versionen mit Weißlicht kann die Farbtemperatur (2700 K, 3200 K, 4000 K) mit dem eingebauten Schalter ausgehend von einem einzigen Artikel geändert werden.

Nelle versioni con luce bianca, l'interruttore integrato permette il cambio di temperatura del colore (2700K, 3200K, 4000K) partendo da un unico codice.



Installationsoptionen Opzioni di installazione

Kann als Aufputz- oder Einbauvariante installiert werden. Die erste Version ist verstellbar und besitzt Arme, die versteckt werden können und mit denen sich der Abstand zwischen der Leuchte und der Wand justieren lässt.

Può essere installato in superficie o ad incasso. La prima versione è orientabile, con bracci inclusi, che ne consentono l'occultamento e regolano anche la distanza tra apparecchio e parete.

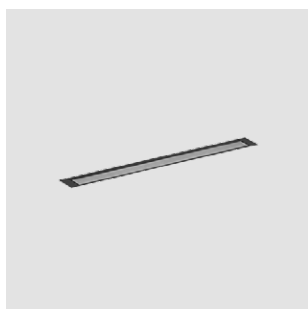

Smart-Funktionen: Fernbedienung der Beleuchtung Funzionalità Smart: Gestione remota dell'illuminazione

Die Mex-Leuchte ermöglicht zusammen mit dem entsprechenden Smart-Zubehör eine Fernsteuerung der Beleuchtung, so dass der Nutzer unabhängig von seinem Standort auf die Beleuchtungsregelung zugreifen kann.

La lampada Mex, con il relativo accessorio Smart, consente di gestire l'illuminazione da remoto, in modo da rendere possibile il controllo dell'illuminazione, indipendentemente dal luogo in cui si trova l'utente.

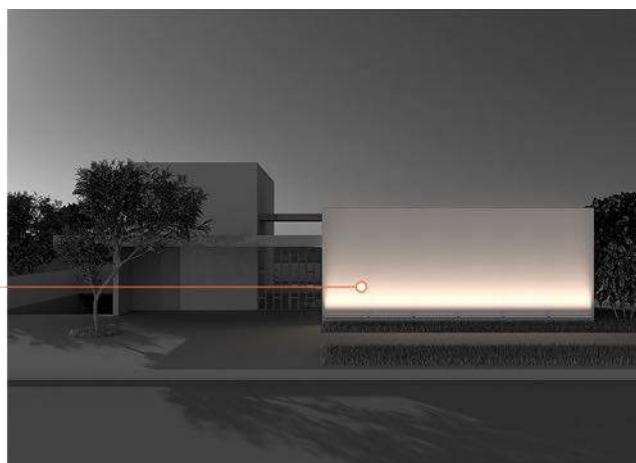

IP 65/67	IK 09	UGR <10	 +15° -90°		 0.2 m	SEA SIDE SUITABLE	 (SC)	3 MacAdam
-------------	----------	------------	--	--	---	----------------------	---	--------------

Z5 ●

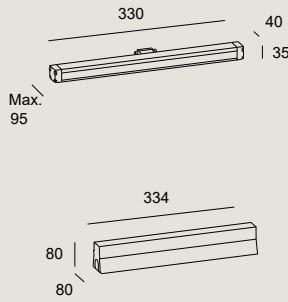

LED						
K	CRI	W LED	W Total	Real Lm	Optics	Code
RGBW		9.8	9.8	151	Flood 71°	05-E094 - Z5 - 00
SW 2700-3200-4000	80	9.8	9.8	314	Flood 50°	05-E093 - Z5 - EH

 24VDC

inklusive / Incluso

Wasserdichte Steckverbinder nach IP67
Connettori stagni IP67

nicht inklusive / Non incluso





Unterputzdose Scatola da incasso	71-E095-05-05
5-m-Kabel mit wasserdichten Schnellsteckverbindern (05-E094) Cavo da 5m con connettori rapidi a tenuta stagna	71-E110-00-00
5-m-Kabel mit wasserdichten Schnellsteckverbindern RGBW (05-E094) Cavo da 5m con connettori rapidi a tenuta stagna RGBW	71-E111-00-00

Smart Compatible-Zub. / Access. Smart Compatibile

71-8050-00-00 Dimmer Casambi PWM 4ch IP20
71-A242-00-00 Driver Casambi PWM 1ch IP66

05-E093	IP		u. min	u. max		Code
				110-127V	220-240V	
	IP68	ON-OFF	1	2	2	71-E101-05-05
		ON-OFF	1	6	6	71-E159-00-00
	IP67	DALI	1	6	6	71-E098-00-00
		0-10V	1	6	6	71-E096-00-00
	Optional IP66 IK09 box (300x200x105mm)					71-E100-00-00

① P. 946

IP 65/67	IK 09	UGR <10	 +15° -90°		 0.2 m	SEA SIDE SUITABLE	 (SC)	 PWM	3 MacAdam
-------------	----------	------------	---	---	--	----------------------	--	---	--------------

Z5 ●

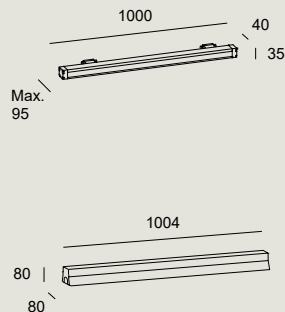

LED						
K	CRI	W LED	W Total	Real Lm	Optics	Code
RGBW		24	24	370	Flood 71°	05-E096 - Z5 - 00
SW 2700-3200-4000	80	24	24	769	Flood 50°	05-E095 - Z5 - EH

 24VDC

nicht inklusive / Non incluso

Unterputzdose Scatola da incasso	71-E095-05-05
5-m-Kabel mit wasserdichten Schnellsteckverbindern (05-E095) Cavo da 5m con connettori rapidi a tenuta stagna	71-E110-00-00
5-m-Kabel mit wasserdichten Schnellsteckverbindern RGBW (05-E095) Cavo da 5m con connettori rapidi a tenuta stagna RGBW	71-E111-00-00

Smart Compatible-Zub. / Access. Smart Compatibile

71-8050-00-00 Dimmer Casambi PWM 4ch IP20
71-A242-00-00 Driver Casambi PWM 1ch IP66



Strahler Proiettori

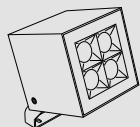

Cube Pro

539

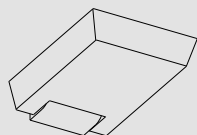

Blade

547

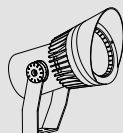

Hubble

551



Max

561

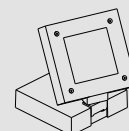

Modis

567



Thor

573

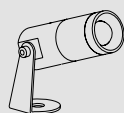

Zoom

579



Micro

583

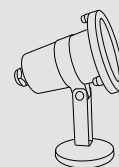

Helio

586

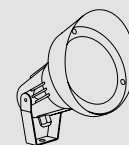

Esparta

588



Suv

589



Cube Pro

BODY MAT	DIF MAT	50000h
AL	GLA	L80 B20



Video ansehen
Guarda il video

Cube Pro ist eine Kollektion leistungsstarker würfelförmiger Strahler mit einem kompakten und zeitlosen Design. Ihre elegante, minimalistische Form und ihr leicht verstellbares Gehäuse, das den Lichtstrahl dorthin lenkt, wo er benötigt wird, machen sie für jede Art von Projekt geeignet.

Cube Pro è una collezione di proiettori cubici ad alte prestazioni e con un design compatto e duraturo nel tempo. La sua forma elegante e minimalista insieme al suo corpo facilmente orientabile per dirigere il fascio di luce dove sia necessario, lo rendono un apparecchio adatto ad ogni tipo di progetto.

Verschiedene Optionen Diverse opzioni



Die Kollektion ist in vier Größen und unterschiedliche Optiken, Leistungen und Farbtemperaturen (einschließlich RGB White DMX) erhältlich. Sie kann auf dem Boden, an der Decke oder an der Wand installiert werden, wobei bei allen Größen die Möglichkeit besteht, die Intensität zu steuern.

È disponibile in 4 misure, ottiche, potenze e temperature di colore (incluso RGB White DMX). Possono essere installati a pavimento, a soffitto o a parete ed ogni misura consente la regolazione dell'intensità.

Diverse Ausstrahlwinkel Opzione di angoli ottici

Für Cube Pro stehen vier Ausstrahlwinkel zur Verfügung, von Ultraspot (6°) bis Flood (50°), die je nach den Anforderungen des Projekts gewählt werden können.

Cube Pro è dotata di 4 opzioni di apertura, da ultraspot (6°) a Flood (50°), da scegliere in base alle esigenze del progetto.

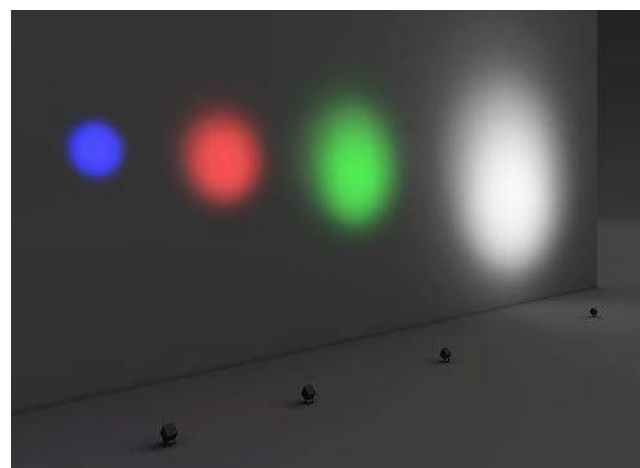

6° - 16° - 35° - 50°

Höchste Langlebigkeit und Widerstandsfähigkeit Massima durabilità e resistenza

Mit Gehäuse aus Aluminiumdruckguss mit speziellem, vor dem Lackieren aufgetragenen Rostschutz, um die Lebensdauer des Produkts zu maximieren und die Installation in nassen Umgebungen oder sogar direkt am Meer zu ermöglichen. Das Doppelgehäuse gewährleistet wiederum eine bessere Wärmeableitung. Mit doppeltem Kabelausgang und der Möglichkeit, eine Blende für höheren visuellen Komfort einzubauen.

Dotato di un corpo in alluminio iniettato con speciale protezione contro la ruggine, prima della verniciatura, per massimizzare la vita utile del prodotto e permettere la sua installazione in ambienti umidi o anche sul lungomare. Il suo doppio corpo garantisce, a sua volta, una migliore dissipazione del calore. Viene fornito con una doppia uscita del cavo e la possibilità di includere una visiera per un maggiore comfort visivo.



Smart

Die Modelle mit 9 und 15 LEDs sind mit einem eingebauten Casambi-Steuergerät ausgestattet, das eine exakte Steuerung von Helligkeit Farbe durch Zeitprogrammierung oder Echtzeit-Interaktion ermöglicht.

I modelli da 9 e 16 LED dispongono all'interno del dispositivo di controllo Casambi, che semplifica l'installazione e consente di gestire l'illuminazione in modo preciso tramite programmazioni orarie o con interazione in tempo reale.

Smart-Funktionen: Fernbedienung der Anlage Funzionalità Smart: Gestione dell'impianto da remoto



Vídeo ansehen
Guarda il video

Eine der Funktionen der Smart-Technologie bei Cube Pro ist die drahtlose Ansteuerung der einzelnen Leuchten. So kann auf die Verlegung eines Signalkabels verzichtet werden und der Installations- und Verwaltungsaufwand ist geringer.

Una delle funzionalità della tecnologia Smart in Cube Pro consiste nel controllo individuale delle luci senza fili, senza il bisogno di passare un cavo di segnale tra di esse, per un'installazione e una gestione più semplici.

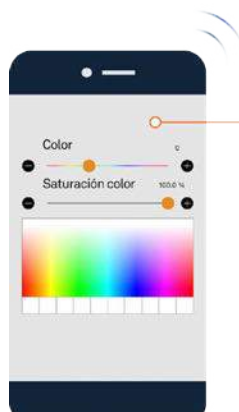

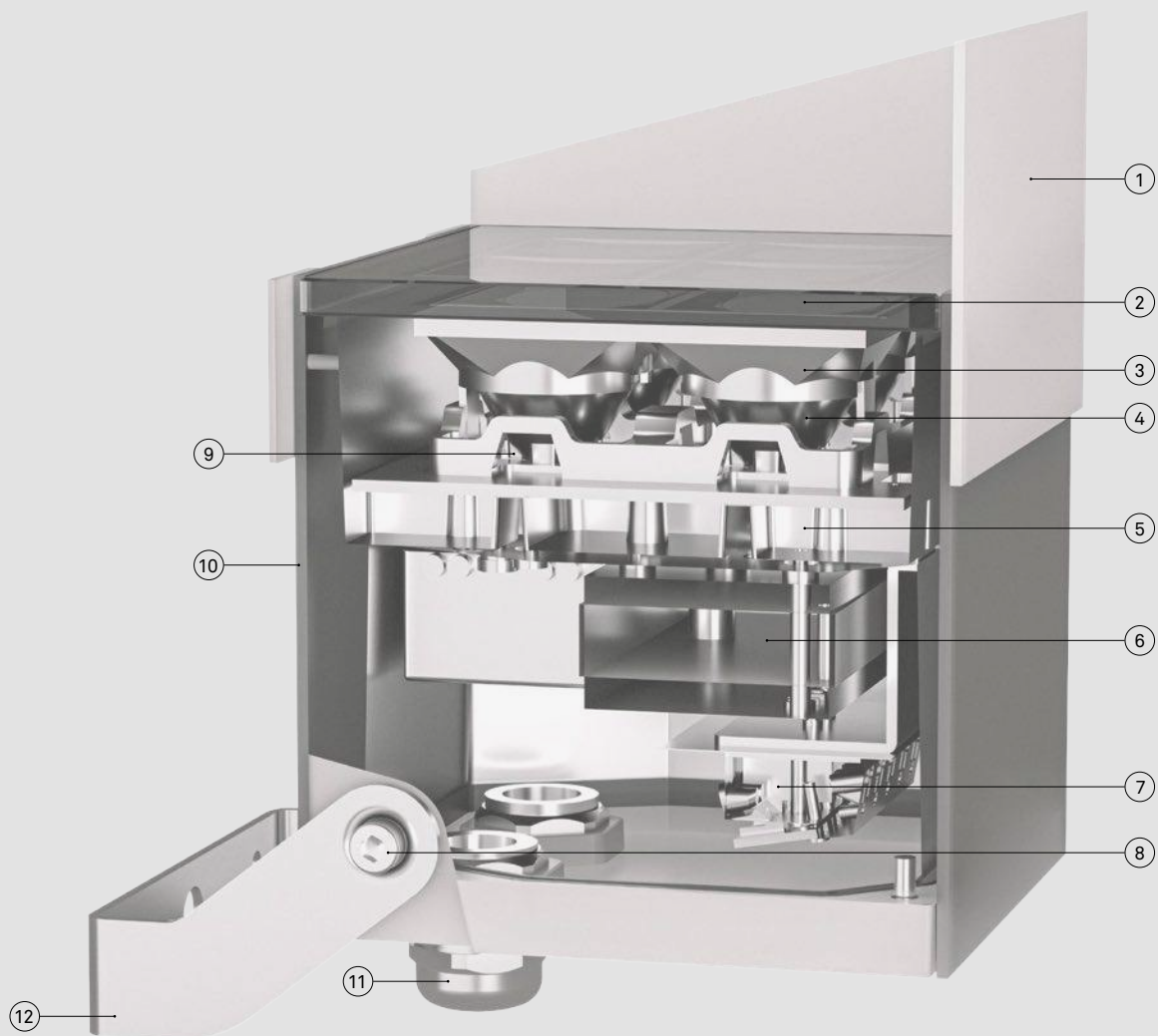

- ① **Blende**
Visiera
Spezieller Blendschutz
Visiera speciale
antiriflesso
- ② **Diffusor**
Diffusore
Glasdiffusor 6 mm
Diffusore in vetro 6mm
- ③ **Zierblende**
Abbellitori
Zierblenden für einen
maximalen Sehkomfort
Abbellitori per
massimizzare il comfort
visivo
- ④ **Optiken**
Ottiche
Große Auswahl an
Optiken von Super Spot
bis Flood
Ampia gamma di ottiche
da Super Spot a Flood
- ⑤ **Wärmeableiter**
Dissipatore
Wärmeableiter aus
Aluminium
Dissipatore in alluminio
- ⑥ **Treiber**
Driver
Regulierbarer On-Off-
Treiber (DALI/Casambi/
DMX)
Driver on-off regolabile
(DALI/Casambi/DMX)
DMX-Controller für
RGBW-Varianten
Controller DMX per le
versioni RGB
- ⑦ **Einfache installation**
Facile installazione
Einfache Montage der
Anschlussleiste ohne
Werkzeug
Morsetto di collegamento
facile senza strumenti
- ⑧ **Finish**
Finiture
Edelstahlschrauben
AISI316
Viti in acciaio inox
AISI316
- ⑨ **Farbtemperatur**
Temperatura di
colore
LED 2700K, 3000K,
4000K, RGBW
LED 2700K, 3000K,
4000K, RGBW
- ⑩ **Struktur**
Struttura
Aluminiumstruktur
mit Korrosionsschutz-
Oberflächenbehandlung
Struttura in alluminio con
processo che comprende
un trattamento
anticorrosione
- ⑪ **Kabeldurchführungen**
Pressacavi
Doppelte
Kabeldurchführung für
Kabeldurchschnitt bis
Ø12
Doppio pressacavo per
cavo fino a Ø12 di sezione
- ⑫ **Sonderzubehör**
Accessori
Ausrichtung.
Schwenkarm 90° swivel
Orientabilità. Braccio
basculante 90°

CUBE PRO

Cube Pro 1 LED



IP
66

IK
03

3
MacAdam



90°

1 m

SEA SIDE
SUITABLE

BREEAM

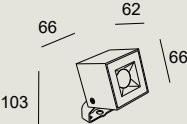
Codebeispiel / Esempio di codice: AN11-P5V8S1BBZ5

Model	W	K/ Cri/ Real lm	Optics	Source	Finishes
 	P5 4,5W	V8 2700K/CRI 80 387 lm	S1 6°	BB  3V/Max. 1500mA	Z5 ●
		W8 3000K/CRI 80 399 lm			
		X8 4000K/CRI 80 411 lm			
	P5 5W	V8 2700K/CRI 80 426 lm	S2 16°	BB  24V/Max. 200mA	
		W8 3000K/CRI 80 439 lm	M3 35°		
		X8 4000K/CRI 80 452 lm	F1 50°		

AN11 6°	IP		u. max			CODE	
			u. min	220-240V	110-127V		
	IP68	DALI	4	15	9	71-E216-00-00	
			0-10V	4	15	9	71-E216-00-00
	IP20	DALI	ON-OFF	1	3	2	71-E217-00-00
			0-10V	1	13	9	71-E221-00-00
	Optional IP66 IK09 box (300x200x105mm)		0-10V	1	13	6	71-E221-00-00

① P. 946

AN11 16-35-50°	IP		u. max			CODE	
			u. min	220-240V	110-127V		
	IP20	DALI	ON-OFF	1	1	1	71-E218-00-00
			0-10V	1	2	2	71-E219-00-00
			Optional IP66 IK09 box (300x200x105mm)				
						71-E100-00-00	

① P. 946

inklusive / Incluso
Blende Visiera







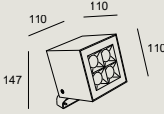

nicht inklusive / Non incluso	
Befestigungssystem auf Pergolen für bis zu 3 Strahler Ancoraggio per pergolati fino a 3 proiettori	71-9746-05-05
Pflock 235 mm Paletto 235mm	71-9997-05-05
Pflock 302mm Paletto 302mm	71-9998-05-05
Befestigungszubehör zur Montage am Mast oder Baum Fissaggio per colonne o alberi	71-9999-Z5-Z5
Sockel für Kabel von Ø 6 mm bis Ø 13,5 mm Base per cavi da Ø6mm a Ø13,5mm	71-E016-Z5-Z5

CUBE PRO

Cube Pro 4 LED



Codebeispiel / Esempio di codice: AN12-P6V8S1DUZ5

Model	W	K/ Cri/ Real lm	Optics	Source	Finishes
 	P6 6W	V8 2700K/CRI 80 647 lm	S1 6°	DU  DALI-2  100-240V 50-60Hz	Z5 
		W8 3000K/CRI 80 667 lm			
		X8 4000K/CRI 80 687 lm			
	12 12W	V8 2700K/CRI 80 1158 lm	S1 6°	OU  ON-OFF 100-240V 50-60Hz	
		W8 3000K/CRI 80 1194 lm			
		X8 4000K/CRI 80 1230 lm			
	12 12W	V8 2700K/CRI 80 1405 lm	S2 16°	DU  DALI-2/100-240V  50-60Hz	
		W8 3000K/CRI 80 1448 lm	M3 35°		OU  ON-OFF/100-240V 50-60Hz
		X8 4000K/CRI 80 1492 lm	F1 51°		
	16 16W	NN RGBW/1170 lm	S1 6°	BB  24VDC	
			S2 16°		
			M3 35°		
F1 51°					

inklusive / Incluso

Blende
Visiera

nicht inklusive / Non incluso

Befestigungssystem auf Pergolen für bis zu 3 Strahler Ancoraggio per pergolati fino a 3 proiettori	71-9746-05-05
Pflock 235 mm Paletto 235mm	71-9997-05-05
Pflock 302mm Paletto 302mm	71-9998-05-05
Befestigungszubehör zur Montage am Mast oder Baum Fissaggio per colonne o alberi	71-9999-Z5-Z5
Sockel für Kabel von Ø 6 mm bis Ø 13,5 mm Base per cavi da Ø6mm a Ø13,5mm	71-E016-Z5-Z5

Smart Compatible-Zub. / Access. Smart Compatibile

71-A237-00-00 Converter Casambi DALI IP66

CUBE PRO

Cube Pro 9 LED

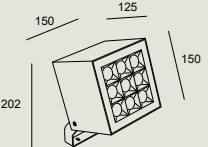

Codebeispiel / Esempio di codice: AN13-24V8S2DUZ5

Model	W	K/ Cri/ Real lm	Optics	Source	Finishes
 	24 24W	V8 2700K/CRI 80 1939 lm	S2 16°	DU DALI-2/120-277V 50-60Hz	Z5
		W8 3000K/CRI 80 1998 lm	M3 35°	XB CASAMBI 110-240V 50-60Hz	
		X8 4000K/CRI 80 2058lm	F1 50°		
	27 27W	V8 2700K/CRI 80 2577 lm	S1 6°	DU DALI-2/120-277V 50-60Hz	
		W8 3000K/CRI 80 2656 lm	XB 35°	XB CASAMBI 110-240V 50-60Hz	
		X8 4000K/CRI 80 2736 lm			
	3P 30W	V8 2700K/CRI 80 2458lm	S1 6°	OU ON-OFF 100-240V 50-60Hz	
		W8 3000K/CRI 80 2535 lm	S2 16°		
		X8 4000K/CRI 80 2611 lm	M3 35°		
			F1 50°		
	25 25W	NN RGBW/CRI 80 1690 lm	S1 6°	DM DMX/100-277V 50-60Hz	
			S2 16°		
M3 35°					
F1 50°					

inklusive / Incluso
Blende Visiera

nicht inklusive / Non incluso	
Pflock 235 mm Paletto 235mm	71-9997-05-05
Pflock 302mm Paletto 302mm	71-9998-05-05
Befestigungszubehör zur Montage am Mast oder Baum Fissaggio per colonne o alberi	71-9999-Z5-Z5
Socket für Kabel von Ø 6 mm bis Ø 13,5 mm Base per cavi da Ø6mm a Ø13,5mm	71-E016-Z5-Z5

Smart Compatible-Zub. / Access. Smart Compatibile
71-A237-00-00 Converter Casambi DALI IP66

CUBE PRO

Cube Pro 16 LED

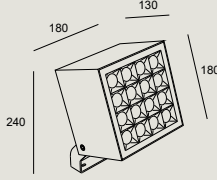

Codebeispiel / Esempio di codice: AN14-5PV8S1DUZ5

Model	W	K/ Cri/ Real lm	Optics	Source	Finishes	
 	5P 50W	V8 2700K/CRI 80 4467 lm	S1 6°	DU DALI/220-240V 50-60Hz	Z5	
		W8 3000K/CRI 80 4605 lm	S2 16°	XB CASAMBI 110-240V 50-60Hz		
		X8 4000K/CRI 80 4743 lm	M3 35°			
			F1 50°			
	53 53W	V8 2700K/CRI 80 4702 lm	S1 6°	OU ON-OFF 100-240V 50-60Hz		
		W8 3000K/CRI 80 4847 lm	S2 16°			
		X8 4000K/CRI 80 4993 lm	M3 35°			
			F1 50°			
	34 34W	NN RGBW/CRI 80 2147 lm	S1 6°	DM DMX 100-277V 50-60Hz		
S2 16°						
M3 35°						
F1 50°						

inklusive / Incluso

Blende
Visiera

nicht inklusive / Non incluso

Pflock 235 mm Paletto 235mm	71-9997-05-05
Pflock 302mm Paletto 302mm	71-9998-05-05
Befestigungszubehör zur Montage am Mast oder Baum Fissaggio per colonne o alberi	71-9999-Z5-Z5
Socket für Kabel von Ø 6 mm bis Ø 13,5 mm Base per cavi da Ø6mm a Ø13,5mm	71-E016-Z5-Z5

Smart Compatible-Zub. / Access. Smart Compatibile

71-A237-00-00 Converter Casambi DALI IP66



Blade

BODY MAT	DIF MAT		50000h	3
AL	GLA		L80 B20	MacAdam



Hoher visueller Komfort Elevato comfort visivo

Eine Kollektion von Strahlern zur indirekten Beleuchtung und Installation an Wand, Decke oder Boden. Blade hat ein schlichtes und elegantes Design mit flacher Struktur für breit scheinendes Licht. Dies ermöglicht die Beleuchtung der Decken und Fassaden von Räumen jeder Art, in denen die besondere architektonische Ästhetik hervorgehoben werden soll. Erhältlich in zwei Größen, wobei die größere Version dank entsprechendem integriertem Treiber gedimmt werden kann. Als Neuheit ist Blade jetzt auch als 4000-K-Variante erhältlich.

Collezione di proiettori per l'illuminazione indiretta che possono essere installati a parete, a soffitto o a pavimento. Blade ha un design sobrio ed elegante dotato di una struttura piatta che offre un'ampia alone di luce. Permette di illuminare soffitti e facciate di ogni tipo di spazio che cerca di valorizzare un'estetica architettonica e distinta. È disponibile in due misure e la versione più grande può essere regolata, includendo un driver regolabile. Come novità Blade include la versione 4000K.

Mit asymmetrischem Metallreflektor zur Optimierung der Lichtintensität und zur Gewährleistung einer perfekten optischen Kontrolle.

Include un riflettore metallico asimmetrico per ottimizzare il flusso luminoso e garantire un perfetto controllo ottico.



Steuerungsoptionen Opzioni di regolazione

Bei der größeren Version besteht die Möglichkeit, die Lichtintensität mithilfe des mitgelieferten verstellbaren Treibers zu steuern.

La versione più grande offre la possibilità di regolare l'intensità della luce grazie al driver dimmerabile incluso.



Maximale Lebensdauer Massima durabilità

Mit einem Gehäuse aus Aluminium, das einer besonderen Rostschutzbehandlung unterzogen wurde, die die Lebensdauer des Produkts maximiert und seine Installation in nassen Umgebungen oder sogar direkt am Meer ermöglicht. Besitzt zudem ein Ventil zur Ableitung des Kondenswassers, wodurch die Lebensdauer der Leuchte optimal verlängert wird.

Dotato di un corpo in alluminio che è stato lavorato con una speciale protezione contro la ruggine per massimizzare la vita utile del prodotto e potendo essere installato in ambienti umidi o anche sul lungomare. Include anche una valvola per evacuare la condensa e quindi massimizzare la durata dell'apparecchio.



Optimale Integration Integrazione ottima

Mit ultraflachem Design (<50 mm) für eine bessere Integration der Leuchte in die Architektur.

Dotato di un design ultrapiatto (<50mm) per una migliore integrazione dell'apparecchio di illuminazione nell'architettura.

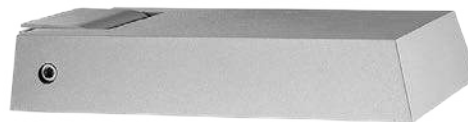

Installationsoptionen Opzioni di installazione

Je nach Installation gibt es verschiedene Versionen für unterschiedliche Projekte, entweder im Boden/in der Wand für die Wandbeleuchtung oder in der Wand für die Deckenbeleuchtung. Presenta diverse versioni a seconda dell'installazione per adattarsi a vari progetti, sia a pavimento/parete per il wallwasher o unicamente a parete, per il wallwasher.

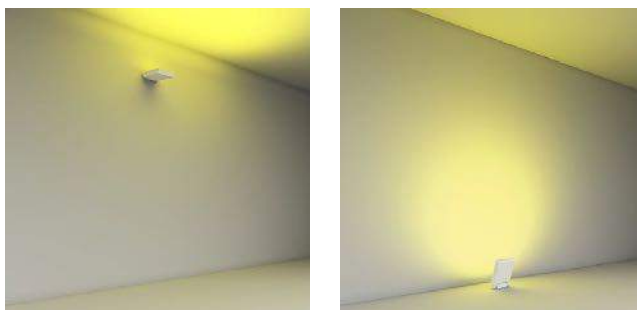

Smart Compatible

Da die größere Version (05-E107) auch dimmbare DALI-Varianten bietet, kann sie mit dem als Zubehör erhältlichen Casambi-DALIIP66- Modul in das Casambi-Steuersystem integriert werden. La versione più grande (05-E107), grazie alle versioni regolabili DALI, è integrabile nel sistema di controllo Casambi grazie all'accessorio Converter Casambi DALI IP66.

BLADE

IP 66	IK 10	±90°	1.5 m	SEA SIDE SUITABLE	ON-OFF	BREEAM
----------	----------	------	-------	----------------------	--------	--------

34

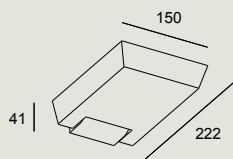

LED						
K	CRI	W LED	W Total	Real Lm	Optics	Code
3000	80	12	14.4	1170	Flood 55°	05-E106 - 34 - CL
4000	80	12	14.4	1170	Flood 55°	05-E106 - 34 - CM
100-277V		50-60Hz				

IP 66	IK 10	±90°	1.5 m	SEA SIDE SUITABLE	BREEAM	(SC)	DALI
----------	----------	------	-------	----------------------	--------	------	------

34

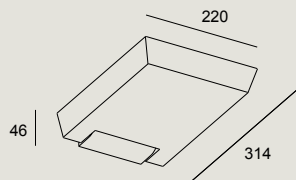

LED						
K	CRI	W LED	W Total	Real Lm	Optics	Code
3000	80	31.7	35.8	2764	Flood 79°	05-E107 - 34 - CL
4000	80	31.7	35.8	2764	Flood 79°	05-E107 - 34 - CM
100-277V		50-60Hz				

Smart Compatible-Zub. / Access. Smart Compatibile

71-A237-00-00 Converter Casambi DALI IP66

nicht mitgeliefertes
allgemeines Zub.
Access. comuni non inclusi

IP68-Stecker mit 6 Eingängen Connettore IP68 a 6 ingressi	71-9199-05-05
IP67-Stecker mit 3 Eingängen Connettore IP67 a 3 ingressi	71-9262-05-05
Befestigungszubehör zur Montage am Mast oder Baum Fissaggio per colonne o alberi	71-9999-Z5-Z5
IP68- Antikondensationsstecker mit 2 Eingängen Connettore IP68 con valvola anticondensa a 2 ingressi	71-E112-00-00
IP68- Antikondensationsstecker mit 4 Eingängen Connettore IP68 con valvola anticondensa a 4 ingressi	71-E122-00-00



Hubble

Hubble Cob

P. 552

Extrem vielseitige LED-Lösung
Soluzione LED altamente versatile



Ø 126 mm



Ø 175 mm



Ø 207 mm



Ø 234 mm

11,5W - 92 W
Spot - Flood



Z5 ●

Hubble GU10 Aluminium

P. 554

GU10-Lösung ideal für sichtbare
starre Oberflächen

Soluzione GU10 perfetta per
superfici rigide a vista



Ø 120 mm

Hubble GU10 Technopolymer

P. 554

GU10-Lösung ideal zum verborgenen
Raseneinbau

Soluzione GU10 perfetta da
nascondere nel prato



Ø 120 mm

34 ● Z5 ● 14 ○

05 ●

HUBBLE



Vielfältig einsetzbare Strahlerkollektion für jeden Beleuchtungsbedarf an Fassaden und in Gärten dank hoher Variantenvielfalt und umfangreichem Zubehör. Mit dem robusten und kompakten Rundgehäuse ist Hubble in verschiedenen Größen und mit zwei Lichtquellen erhältlich: LED und GU10. Alle Ausführungen werden mit einer abnehmbaren Blende zur Verbesserung des visuellen Komforts und Vermeidung von Blendwirkungen ausgeliefert.

Collezione di proiettori versatili da usare per qualsiasi necessità di illuminazione su facciate e in giardini grazie all'ampia gamma di versioni e ai numerosi accessori disponibili. Con un corpo robusto, arrotondato e compatto, Hubble è disponibile in varie misure e con due sorgenti di luce: LED e GU10. Tutte le versioni dispongono di accessorio visiera incluso, per ottimizzare il comfort visivo ed evitare l'abbagliamento.

HUBBLE COB



Hubble Cob ist die umfangreichste Kollektion der Hubble-Familie und ist in vier Größen, drei Farbtemperaturen (2700K, 3000K und 4000K) und einem Finish erhältlich. Das Aluminiumgehäuse ist speziell gegen Korrosion behandelt, sodass die Leuchten auch in Umgebungen mit Seeatmosphäre installiert werden können.

È la collezione più estesa della famiglia Hubble, disponibile in 4 misure, 3 temperature di colore (2700K, 3000K e 4000K) e in una finitura. Ha un corpo in alluminio con una speciale protezione contro la ruggine, grazie alla quale può essere installata anche in ambienti con atmosfera marina.

Optische Winkel Angoli ottici

Alle Hubble Cob-Leuchten sind serienmäßig mit zwei Reflektoren (Spot und Medium) ausgestattet. So kann der Lichtstrahl auch bereits während der Installation eingestellt werden, was die Vielseitigkeit erhöht.

Tutti gli apparecchi Hubble Cobb sono dotati di due riflettori di serie (Spot e Medium) per regolare il fascio di luce anche durante l'installazione, per una maggiore versatilità.



15°

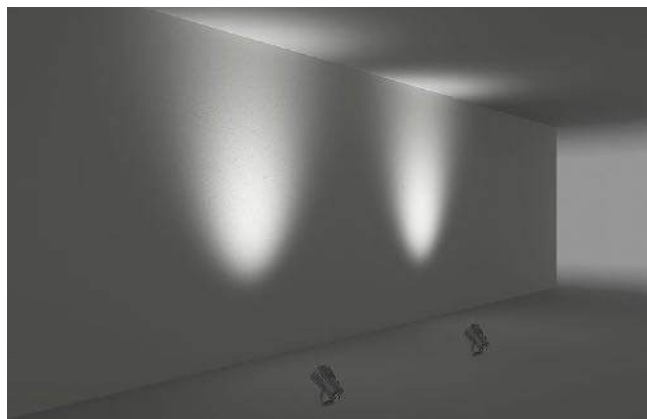

35°

Höchster visueller Komfort Massimo comfort visivo

Zusätzlich zur Blende wird ein spezielles Blendschutzzubehör mitgeliefert, um das Restlicht zu verringern und den visuellen Komfort zu steigern (in allen Ausführungen außer der größten Leuchte 05-E083).

Oltre alla visiera, è incluso uno speciale accessorio antiabbagliamento per ridurre la luce residua e massimizzare il comfort visivo (in tutte le versioni tranne la più grande: 05-E083).



Befestigungszubehör Accessorio di fissaggio

Hubble Cob kann mit dem Zubehör 71-9999 auch an vertikalen Strukturen befestigt werden. Das Befestigungssystem umfasst sowohl Metallschellen als auch elastische Bänder, mit denen der Montagedurchmesser an die Größe von Säulen oder Bäumen angepasst werden kann. Empfohlen für alle Versionen außer der größten Bauform 05-E083.

Grazie all'accessorio 71-9999, Hubble Cob può essere fissato a strutture verticali. Questo sistema di fissaggio include sia staffe metalliche che fasce elastiche per regolare il diametro di fissaggio e adattarsi a qualsiasi tipo di colonna e albero. Consigliato in tutte le versioni tranne la più grande 05-E083.



Reiheninstallation Installazione in serie

Doppelter Kabelausgang, um die Reiheninstallation bei größeren und komplexeren Projekten zu vereinfachen (alle Ausführungen außer der kleinsten Bauform 05-9989).

Dispone di una doppia uscita del cavo per facilitare l'installazione in serie in progetti complessi più grandi (in tutte le versioni tranne la più piccola: 05-9989).



HUBBLE GU10 ALUMINIUM



Die Produktreihe Hubble GU10 Aluminium ist dank ihrer perfekten Lackierung, die in den Farben Dunkelgrau, Hellgrau und Weiß erhältlich ist, für die Installation auf exponierten Flächen wie Fassaden und Fußböden in Wohnbereichen vorgesehen. Das Aluminiumgehäuse ist speziell gegen Korrosion behandelt, sodass die Leuchten auch in Umgebungen mit Seeatmosphäre installiert werden können. Erhältlich als GU10-Lichtquelle für den Einsatz auswechselbarer Leuchtmittel, einschließlich Blende.

La collezione Hubble Gu10 Aluminium è pensata per installazioni su superfici a vista come facciate e pavimenti di zone residenziali, grazie alla perfetta finitura colorata, disponibile in grigio scuro, grigio chiaro e bianco. Ha un corpo in alluminio con una speciale protezione contro la ruggine, grazie alla quale può essere installata anche in ambienti con atmosfera marina. Disponibile con sorgente luminosa GU10 per l'uso di lampadine intercambiabili e accessorio visiera incluso.

Befestigungszubehör Accessorio di fissaggio

Hubble GU10 Aluminium kann mit dem Zubehör 71-9746 auch an vertikalen Strukturen befestigt werden. Das Befestigungssystem enthält Zubehör zur Befestigung von bis zu drei Strahlern und elastische Bänder mit Klettverschluss zur Anpassung an alle Arten von Pfosten wie Pergolen oder Sonnenschirme in der Außengastronomie.

Grazie all'accessorio 71-9746, Hubble GU10 Aluminium può essere fissato a strutture verticali. Questo sistema include accessori per fissare fino a 3 proiettori e fasce elastiche con velcro per adattarsi a qualsiasi tipo di installazione come pergole o tettoie di bar e terrazze.

HUBBLE GU10 TECHNOPOLYMER



Die Kollektion Hubble GU10 Technopolymer besteht zu 100 % aus Technopolymer-Spritzguss mit einer rauen und heterogenen Oberfläche, die für den ständigen Kontakt mit feuchten Oberflächen und rauen Umgebungen ausgelegt ist. Die extrem widerstandsfähige Oberfläche ermöglicht eine Installation in Gärten und Räumen mit üppiger Vegetation, Bewässerungssystemen und Chemikalieneinwirkung. Es sind 2 auswechselbare Lampenfassungen enthalten: GU10 für Netzspannung und GU5.3 für Niederspannungsversorgung. Zum Lieferumfang gehören auch eine Blende und ein Haltepflock zum Einstecken in weichen Untergrund.

La collezione Hubble GU10 Technopolymer è prodotta al 100% in tecnopolimero iniettato, con una finitura rugosa ed eterogenea, pensata per il contatto permanente con superfici umide e ambienti difficili. La finitura estremamente resistente consente di installarla in giardini e spazi con abbondante vegetazione, acqua di irrigazione ed esposizione agli agenti chimici. Dispone di 2 portalamпада intercambiabili inclusi: GU10 per progetti con tensione di fornitura e GU5.3 per progetti a bassa tensione. Include anche un accessorio visiera e un picchetto per il fissaggio su superfici morbide.

HUBBLE

Hubble Cob

BODY MAT	IP	IK	50000h	3		SEA SIDE		BREEAM
AL	65	07	L80 B20	MacAdam	±90°	SUITABLE	ON-OFF	

Z5

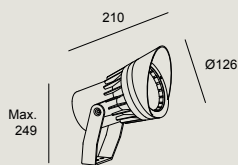

LED						
K	CRI	W LED	W Total	Real Lm	Optics	Code
2700	80	11.5	13.1	1167	Spot 11°	05-9989 - Z5 - CK
3000	80	11.5	13.1	1167	Spot 11°	05-9989 - Z5 - CL
4000	80	11.5	13.1	1251	Spot 11°	05-9989 - Z5 - CM
100-240V		50-60Hz				

inklusive / Incluso

Blende
Visiera
10° und 33° Reflektoren
Riflettori 10° e 33°
Blendschutz
Antiriflesso

nicht inklusive / Non incluso

Befestigungssystem auf Pergolen für bis zu 3 Strahler Ancoraggio per pergolati fino a 3 proiettori	71-9746-05-05
Pflock 235 mm Paletto 235mm	71-9997-05-05
Pflock 302mm Paletto 302mm	71-9998-05-05
Befestigungszubehör zur Montage am Mast oder Baum Fissaggio per colonne o alberi	71-9999-Z5-Z5
Sockel für Kabel von Ø 6 mm bis Ø 13,5 mm Base per cavi da Ø6mm a Ø13,5mm	71-E016-Z5-Z5
Verlängerungskabel mit 300 + 500 mm Länge für Wand, Boden und Rasen Stensione di 300+500mm per parete, pavimento e prato..	71-E052-Z5-Z5

HUBBLE

Hubble Cob

BODY MAT	IP	IK	50000h	3			SEA SIDE		BREEAM
AL	65	08	L80 B20	MacAdam	±90°		SUITABLE	ON-OFF	

Z5 ●

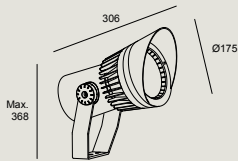

LED						
K	CRI	W LED	W Total	Real Lm	Optics	Code
2700	80	33	35.2	3589	Spot 16°	05-9959 - Z5 - CK
3000	80	33	35.2	3589	Spot 16°	05-9959 - Z5 - CL
4000	80	33	35.2	3804	Spot 16°	05-9959 - Z5 - CM
100-240V		50-60Hz				

inklusive / Incluso

Blende

Visiera

15° und 35° Reflektoren

Riflettori 15° e 35°

Blendschutz

Antiriflesso

nicht inklusive / Non incluso

Pflock 235 mm

71-9997-05-05

Paletto 235mm

Pflock 302mm

71-9998-05-05

Paletto 302mm

Befestigungszubehör zur Montage am Mast oder Baum

71-9999-Z5-Z5

Fissaggio per colonne o alberi

Sockel für Kabel von Ø 6 mm bis Ø 13,5 mm

71-E016-Z5-Z5

Base per cavi da Ø6mm a Ø13,5mm

Verlängerungskabel mit 300 + 500 mm Länge für Wand, Boden und Rasen

71-E052-Z5-Z5

Stensione di 300+500mm per parete, pavimento e prato..

HUBBLE

Hubble Cob

BODY MAT	IP	IK	50000h	3			SEA SIDE		BREEAM
AL	65	08	L80 B20	MacAdam	±90°		SUITABLE	ON-OFF	

Z5 ●

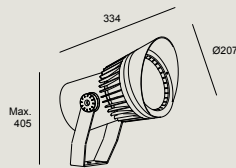

LED						
K	CRI	W LED	W Total	Real Lm	Optics	Code
2700	80	52	56.4	5266	Spot 16°	05-9960 - Z5 - CK
3000	80	52	56.4	5631	Spot 16°	05-9960 - Z5 - CL
4000	80	52	56.4	5631	Spot 16°	05-9960 - Z5 - CM
100-240V		50-60Hz				

inklusive / Inclusoo

Blende
Visiera
15° und 35° Reflektoren
Riflettori 15° e 35°
Blendschutz
Antiriflesso

nicht inklusive / Non incluso

Pflock 235 mm Paletto 235mm	71-9997-05-05
Pflock 302mm Paletto 302mm	71-9998-05-05
Socket für Kabel von Ø 6 mm bis Ø 13,5 mm Base per cavi da Ø6mm a Ø13,5mm	71-E016-Z5-Z5
Arm zur Mastbefestigung Kit per fissaggio a palo	71-E058-Z5-00



HUBBLE

Hubble Cob

BODY MAT	IP	IK	50000h	3	LOW				BREEAM	
AL	66	09	L80 B20	MacAdam	FLICKER	±90°		DALI		

Z5 ●

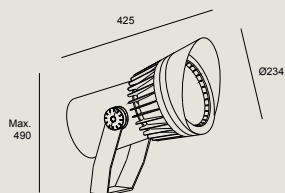

LED						
K	CRI	W LED	W Total	Real Lm	Optics	Code
2700	80	92	96.8	9931	Spot 20°	05-E083 - Z5 - CK
3000	80	92	96.8	10552	Spot 20°	05-E083 - Z5 - CL
4000	80	92	96.8	10863	Spot 20°	05-E083 - Z5 - CM

	220-240V	50-60Hz
--	----------	---------

inklusive / Incluso
Blende Visiera
15°- und 36°-Strahler Riflettori 15° e 36°

nicht inklusive / Non incluso	
Pflock 235 mm Paletto 235mm	71-9997-05-05
Pflock 302mm Paletto 302mm	71-9998-05-05
Socket für Kabel von Ø 6 mm bis Ø 13,5 mm Base per cavi da Ø6mm a Ø13,5mm	71-E016-Z5-Z5
Arm zur Mastbefestigung Kit per fissaggio a palo	71-E058-Z5-00

Smart Compatible-Zub. / Access. Smart Compatibile
71-A237-00-00 Converter Casambi DALI IP66

HUBBLE

Hubble GU10 Aluminium

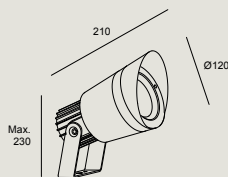

NEW	BODY MAT	IP	IK	±90°	SEA SIDE
	AL	65	06		SUITABLE

14 34 Z5

GU10		
W	Optics	Code
1 x max. 50	Medium 40°	14 05-9416 - 34 - 37 Z5

inklusive / Incluso

Blende
Visiera

nicht inklusive / Non incluso

Befestigungssystem auf Pergolen für bis zu 3 Strahler Ancoraggio per pergolati fino a 3 proiettori	71-9746-05-05
Pflock 235 mm Paletto 235mm	71-9997-05-05
Pflock 302mm Paletto 302mm	71-9998-05-05
Befestigungszubehör zur Montage am Mast oder Baum Fissaggio per colonne o alberi	71-9999-Z5-Z5
Socket für Kabel von Ø 6 mm bis Ø 13,5 mm Base per cavi da Ø6mm a Ø13,5mm	71-E016-Z5-Z5
Verlängerungskabel mit 300 + 500 mm Länge für Wand, Boden und Rasen Stensione di 300+500mm per parete, pavimento e prato..	71-E052-34-34
Verlängerungskabel mit 300 + 500 mm Länge für Wand, Boden und Rasen Stensione di 300+500mm per parete, pavimento e prato..	71-E052-Z5-Z5

HUBBLE

Hubble GU10 Technopolymer

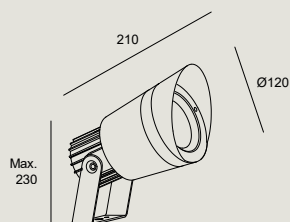

BODY MAT	IP	IK	±90°	SEA SIDE
POLI	65	06		SUITABLE

05

GU10	
W	Code
1 x max. 35	05-9722 - 05 - 37

inklusive / Incluso

Blende
Visiera

Erdspieß
Picchetto

2 Lampenfassungen GU5.3 + GU10
2 portalampade GU5.3 + GU10

nicht inklusive / Non incluso

Befestigungssystem auf Pergolen für bis zu 3 Strahler Ancoraggio per pergolati fino a 3 proiettori	71-9746-05-05
Pflock 235 mm Paletto 235mm	71-9997-05-05
Pflock 302mm Paletto 302mm	71-9998-05-05
Befestigungszubehör zur Montage am Mast oder Baum Fissaggio per colonne o alberi	71-9999-Z5-Z5
Socket für Kabel von Ø 6 mm bis Ø 13,5 mm Base per cavi da Ø6mm a Ø13,5mm	71-E016-Z5-Z5



Max

BODY MAT	DIF MAT		50000h
AL	GLA		L80 B20



Vídeo ansehen
Guarda il video

Installationsoptionen Opzioni di installazione

Öffnungswinke Angoli di apertura

Der Strahler der Max-Familie, der modularsten des LEDS C4-Sortiments für den Außenbereich, ist in zwei Formaten erhältlich: mit Stange zur erhöhten Verwendung und ohne Stange für die flache Verwendung. Er ist mit 3 Farbtemperaturen und 4 Abstrahlwinkeln erhältlich und wurde jetzt durch leistungsstärkere und größere Modellvarianten ergänzt, die auch bei umfangreicheren Projekte optimale Lösungen bieten. Als Ergänzung sind eine Wabenplatte und ein Filter zur Lichtstreuung für ovales Licht und quadratisches Licht erhältlich. Außerdem können eine Blende zur Verbesserung des Sehkomforts und ein Pflock zur Aufstellung auf dem Rasen installiert werden. Mit Ausnahme der Uplight-Version kann die gesamte Kollektion mit den von LEDS C4 angebotenen Farben individuell gestaltet werden.

Il proiettore della famiglia Max, la più modulare della linea per esterno della LEDS C4, è disponibile in 2 formati: con asta, per uso rialzato e senza asta, per uso a pavimento. Esiste in 3 temperature e in 4 angolazioni diverse e sono disponibili modelli più potenti e più grandi per risolvere progetti di portata maggiore. Inoltre, può essere completato con un pannello a nido d'ape e con filtri a luce diffusa, luce ovale o luce quadrata. Permette inoltre di installare una visiera per migliorare il comfort visivo, nonché un picchetto per installazione su prato. Ad eccezione della versione uplight, tutta la collezione è personalizzabile con i colori offerti dalla LEDS C4.

Das Modell mit Stange für erhöhte Leuchtenposition kann direkt im Boden oder auf dem Befestigungssockel für Bodenbeläge und starre Böden installiert werden.

Il modello con asta per uso rialzato può essere installato direttamente nel terreno o sulla base di fissaggio per superfici pavimentate o rigide.

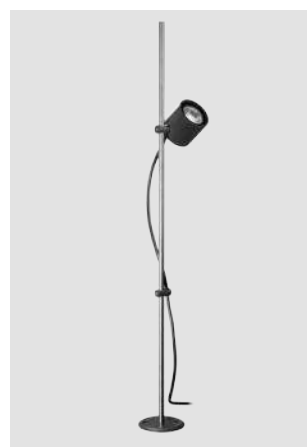

Der Max-Strahler ist in drei Farbtemperaturen und vier Winkeln erhältlich, die von Ultraspot (8,6°) bis Ultraflood (50°) reichen, so dass er sich leicht an die Anforderungen aller Projekte anpassen lässt.

Il proiettore Max è disponibile in 3 temperature di colore e 4 angoli che vanno da Ultraspot (8,6°) a Ultraflood (50°), per adattarsi facilmente alle esigenze di tutti i progetti.



Farbausführungen The Colours Finiture The Colours

Max ist als Strahler, Deckeneinbau-, Wand- und Deckenleuchte in allen The Colours-Farbtönen des LEDS C4-Katalogs erhältlich und als Zubehör mit Blende lieferbar.

Max proiettore, faretto da soffitto, applique e lampadario è disponibile in tutte le finiture The Colours del catalogo LEDS C4, come anche l'accessorio opzionale visiera.



Kompaktes Design Design compatto

Das neutrale und kompakte Design ermöglicht den Einbau in alle Arten von Innenräumen, was es zu einem jederzeit attraktiven, diskreten und eleganten Produkt macht.

Il suo design neutro e compatto ne favorisce l'installazione in tutti i tipi di interni, rendendolo un pezzo attraente, discreto ed elegante.



Ökodesign Ecodesign

Ökodesign dank austauschbarer LED-Module. Mit einem niedrigen Blendungswert von UGR <12 weist Max einen hohen Sehkomfort auf und bietet mit einer hohen Farbwiedergabe von CRI90.

Il suo design risponde a un parametro ecologico, grazie all'utilizzo di moduli LED sostituibili. Dotato di un elevato comfort visivo contraddistinto da un UGR < 12, Max offre un'elevata resa cromatica con un CRI90.



Maximale Leistung Massime prestazioni

Max verfügt über eine kompakte Struktur, die beständig gegenüber den Witterungsbedingungen am Meer ist und aus austauschbaren LED-Modulen im ökologischen Design, einem Glasdiffusor mit IK10-Widerstand und hermetischer Abdichtung nach IP65 sowie einer Auswahl verschiedener Streulicht-, ovaler und quadratischer Filter besteht.

Max è dotato di una struttura compatta e resistente all'atmosfera marina, essendo composto da moduli LED eco-progettati per essere sostituibili, un diffusore in vetro, con resistenza IK10 e chiusura ermetica, per garantire un IP65; si permette, inoltre, la scelta tra diversi filtri di luce diffusa, ovale e quadrata.

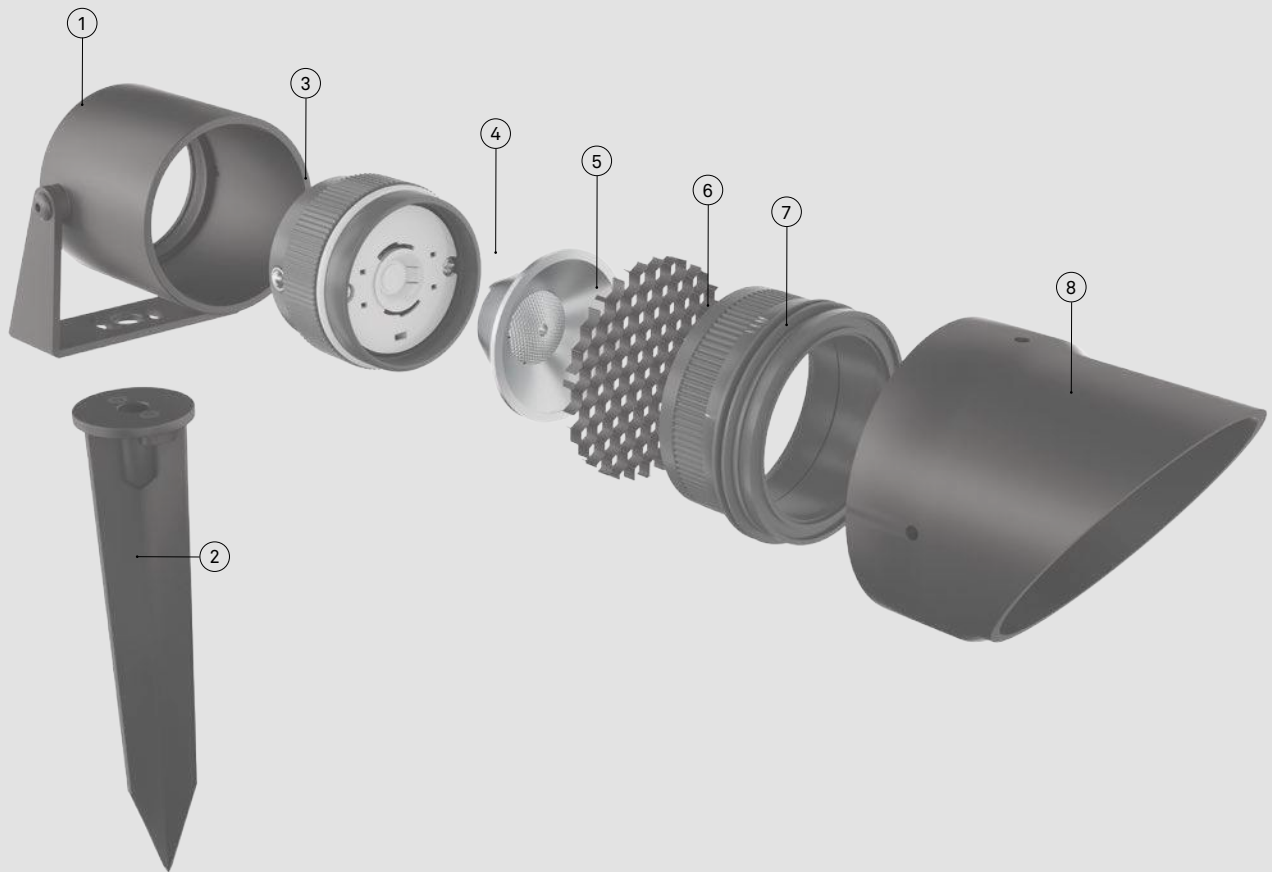

① **Struktur**
Struttura
Spot Surface
Spot Bollard

③ **Modul**
Modulo
Umweltfreundlich
austauschbare
LED-Module
Moduli LED
eco-progettati per essere
sostituiti

⑦ **Abdichtung**
Chiusura
Hermetische
Abdichtung nach IP65
Chiusura ermetica per
garantire IP65

**Zubehör im
lieferumfang enthalten**
Accessori
inclusi

④ **Öffnungswinkel:**
8,6° - 17° - 27° - 50°
Angoli di apertura:
8,6° - 17° - 27° - 50°

Sonderzubehör
Accessori opzionali

② **Spieß zur
Bodenbefestigung**
Picchetto per
installazione su erba

⑥ **Elliptischer Diffusor,
quadratischer Diffusor,
Wabenplatte oder
Lichthof-Diffusor**
Diffusore ellittico,
diffusore quadrato,
pannello a nido d'ape o
diffusore dell'alone









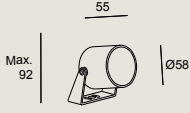

⑧ **Visor to enhance visual
pleasure**
Visière permettant
d'améliorer le confort
visuel

MAX

Max Spotlight

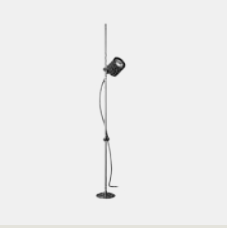
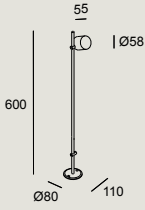
BODY MAT	DIF MAT	IK	SEA SIDE SUITABLE	IP
AL	GLA			

Codebeispiel / Esempio di codice: AI18-P4V9S1BBZ5

Model	W	K/ Cri/ Real lm	Optics	Source	Finishes
AI18 - Ohne halterung / Senza asta  	P4 4W	V9 2700K CRI90/286 lm	S1 9°	BB  12V Max. 350mA	Z5  14*  60*  34* 
		W9 3000K CRI90/286 lm			
		X9 4000K CRI90/286 lm			
AI17 - Mit Halterung / Con asta  	P7 6,5W	V9 2700K CRI90/519 lm	S2 17°	BB  18V Max. 350mA	J6*  E3*  DL* 
		W9 3000K CRI90/519 lm			
		X9 4000K CRI90/519 lm			

AI11 AI12 AI13 AI14 AI15 AI16 AI17 AI18	IP 	u. min	u. max				Code
			P4 (8,6°)		P7 (17°/ 27°/ 50°)		
			220-240V	110-127V	220-240V	110-127V	
	ON-OFF	1	4	3	2	2	71-E079-00-00
	DALI	1	4	4	2	2	71-E083-00-00
	0-10V	1	4	4	2	2	71-E083-00-00
	ON-OFF	1	6	6	4	4	71-3542-00-00
	DALI	1	6	6	4	4	71-4706-00-00
	0-10V	1	6	6	4	4	71-4706-00-00
	Optional IP66 IK09 box (300x200x105mm)						71-E100-00-00

① P. 946

nicht inklusive / Non incluso	
IP68-Stecker mit 6 Eingängen / Connettore IP68 a 6 ingressi	71-9199-05-05
IP67-Stecker mit 3 Eingängen / Connettore IP67 a 3 ingressi	71-9262-05-05
IP68- Antikondensationsstecker mit 2 Eingängen / Connettore IP68 con valvola anticondensa a 2 ingressi	71-E112-00-00
5 Wabenraster / 5 pannelli a nido d'ape	71-E131-00-00
5 Lichtfilter für gestreute Lichtkegel / 5 filtri per l'emissione di luce diffusa	71-E133-00-00
5 Lichtfilter für quadratische Lichtkegel / 5 filtri per l'emissione di luce quadrata	71-E135-00-00
5 Lichtfilter für elliptische Lichtkegel / 5 filtri per emettere luce ellittica	71-E141-00-00
Erdbefestigungsspieß / Picchetto di fissaggio a terra (AI18)	71-E143-05-05
Blende weiß / Visiera grigia	71-E145-14-14
Blende hellgrau / Visiera grigio chiaro	71-E145-34-34
Blende schwarz / Visiera nera	71-E145-60-60
Blende gold / Visiera dorata	71-E145-DL-DL
Blende tannengrün / Visiera verde abete	71-E145-E3-E3
Blende braun / Visiera marrone	71-E145-J6-J6
Blende weiß / Visiera grigia	71-E145-Z5-Z5

*Fragen Sie unser Verkaufsteam nach den Lieferbedingungen.









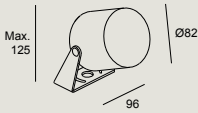

Consultare i termini e le condizioni di consegna al nostro team commerciale.

MAX

Max Spotlight

NEW	BODY MAT AL	DIF MAT GLA	IK 10	2 MacAdam	1 m	SEA SIDE SUITABLE	IP 66
-----	----------------	----------------	----------	--------------	-----	----------------------	----------

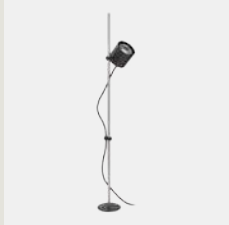
Codebeispiel / Esempio di codice: AT18-18V9S3BBZ5

Model	W	K/ Cri/ Real lm	Optics	Source	Finishes
AT18 - Ohne Halterung / Senza asta  	18 17,3W	V9 2700K CRI90/1902 lm	S3 21°	BB  36V Max.500mA	Z5  14*  60*  34*  J6*  E3*  DL* 
		W9 3000K CRI90/2047 lm	M3 31°		
		X9 4000K CRI90/2191 lm	F1 40°		
AT17 - Mit Halterung / Con asta  					

	IP		u. min	u. max		Code
				220-240V	110-127V	
AT11						
AT12						
AT13		ON-OFF	1	1	1	71-E068-00-00
AT14						
AT15	IP68	DALI	1	1	1	71-E085-00-00
AT16		0-10V	1	1	1	71-E085-00-00
AT17						
AT18		ON-OFF	1	2	2	71-3542-00-00
	IP20	DALI	1	2	2	71-4706-00-00
		0-10V	1	2	2	71-4706-00-00
	Optional IP66 IK09 box (300x200x105mm)					71-E100-00-00

① P. 946

nicht inklusive / Non incluso	
IP68-Stecker mit 6 Eingängen / Connettore IP68 a 6 ingressi	71-9199-05-05
IP67-Stecker mit 3 Eingängen / Connettore IP67 a 3 ingressi	71-9262-05-05
Pflock 235 mm / Paletto 235mm (AT18)	71-9997-05-05
Pflock 302mm / Paletto 302mm (AT18)	71-9998-05-05
IP68- Antikondensationsstecker mit 2 Eingängen / Connettore IP68 con valvola anticondensa a 2 ingressi	71-E112-00-00
5 Wabenraster / 5 pannelli a nido d'ape	71-E263-00-00
5 Lichtfilter für gestreute Lichtkegel / 5 filtri per l'emissione di luce diffusa	71-E260-00-00
5 Lichtfilter für quadratische Lichtkegel / 5 filtri per l'emissione di luce quadrata	71-E262-00-00
5 Lichtfilter für elliptische Lichtkegel / 5 filtri per emettere luce ellittica	71-E261-00-00
Blende weiß / Visiera grigia	71-E259-14-00
Blende hellgrau / Visiera grigio chiaro	71-E259-34-00
Blende schwarz / Visiera nera	71-E259-60-00
Blende gold / Visiera dorata	71-E259-DL-00
Blende tannengrün / Visiera verde abete	71-E259-E3-00
Blende braun / Visiera marrone	71-E259-J6-00
Blende weiß / Visiera grigia	71-E259-Z5-00

*Fragen Sie unser Verkaufsteam nach den Lieferbedingungen.

Consultare i termini e le condizioni di consegna al nostro team commerciale.



OUTDOOR STRAHLER / PROIETTORI



Modis

LUCA TURRINI 2022

BODY MAT	DIF MAT		50000h	3
AL	GLA		L80 B20	MacAdam



Modis ist ein neuer Vorschlag für den Außenbereich mit einer ausgeprägt dekorativen Komponente. Ein klares und neutrales Profil sowie eine Konstruktion, die eine hohe Beweglichkeit des Kugelgelenks erlaubt und die Möglichkeit bietet, die Abstrahlungsart zu wählen, denn die Leuchte ist wahlweise mit konzentriertem oder gebündeltem Licht erhältlich. Die vielköpfige Familie der Kollektion und ihre Kompositionsmöglichkeiten machen sie zu einer Lösung, die sich durch ihre Vielseitigkeit auszeichnet und sich meisterhaft und elegant an die Anforderungen von Projekten anpasst, die ein ästhetisches Gleichgewicht im Gesamtbild erfordern. Neben den dekorativen Vorzügen wurde auch den technischen Aspekten große Aufmerksamkeit gewidmet, um die Vielseitigkeit der Familie noch stärker zu betonen. Modis weist eine hohe Stoßfestigkeit (IK10), Staubbichtheit und Hochdruckwasserbeständigkeit (IP66) auf und kann dank der KTL-Grundierung auch in Umgebungen mit harter Seeluft aufgestellt werden.

Modis è una nuova proposta da esterno con una grande componente decorativa. Dal profilo pulito e neutro, il suo design si basa sulla grande capacità di movimento dello snodo e sulla possibilità di scegliere il fascio di luce, con opzione luce concentrata o diffusa. La grande famiglia della collezione e le sue possibilità compositive la trasformano in una scelta caratterizzata da versatilità e adattabile con maestria ed eleganza alle esigenze di progetti che richiedono insieme esteticamente equilibrati. Oltre al valore decorativo, gli aspetti tecnici sono stati curati fin nei minimi dettagli, per offrire una linea ancora più polivalente. Modis ha una grandissima resistenza agli urti (IK10), un'eccellente protezione dall'ingresso di polvere e acqua ad alta pressione (IP66) e può essere installata in ambienti con atmosfera marina, grazie al processo di verniciatura in catanofresi.

Beleuchtungsanlagen Sistemi di illuminazione

Alle Mitglieder der Modis-Familie sind mit zwei Innenmodulen erhältlich, bei denen je nach den Anforderungen der zu beleuchtenden Umgebung zwischen Opal- und Optics-Optik gewählt werden kann. Die Opal-Variante ist für die Grundbeleuchtung vorgesehen und mit der Optics-Option kann der Lichtschein zum Hervorheben von einzelnen Objekten oder Szenen gebündelt werden, wobei die Optiken Spot 18°, Medium 34° und Flood 48° zur Auswahl stehen. Darüber hinaus bietet die Optics-Variante einen hervorragenden visuellen Komfort (UGR<16) und eine hohe Lichtqualität (CRI90).

In tutta la famiglia Modis presenta due moduli interni a scelta tra ottica Opal e Optics, in base alle esigenze dell'ambiente da illuminare. La versione Opal offre un'illuminazione generale mentre l'opzione Optics consente di concentrare il fascio per mettere in risalto oggetti o scene concrete, con la possibilità di scegliere tra ottica Spot 18°, Medium 34° e Flood 48°. Inoltre, la versione Optics offre un grande comfort visivo (UGR<16) e una luce di qualità (CRI90).



Opal



Optics

MODIS

Modis Opal Wall Fixture/Spotlight/ Ceiling

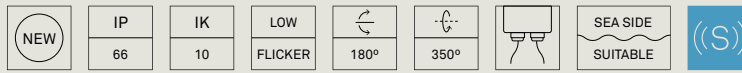

14* ○ 34* ● 60* ● DL* ● E3* ● J6* ● Z5 ●

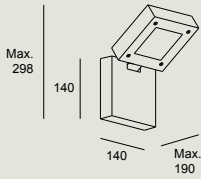

LED						
K	CRI	W LED	W Total	Real Lm	Code	
SW 2700-3200-4000	80	11.6	13.2	744	14	
					34	
					60	DU
					E3	OU
					J6	XB
					Z5	

XB	Casambi	220-240V	50-60Hz
DU	DALI-2	100-277V	50-60Hz
OU	ON-OFF	100-277V	50-60Hz



nicht inklusive / Non incluso	
Pflock 235 mm / Paletto 235mm	71-9997-05-05
Pflock 302mm / Paletto 302mm	71-9998-05-05



14* ○ 34* ● 60* ● DL* ● E3* ● J6* ● Z5 ●

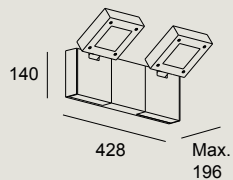

LED						
K	CRI	W LED	W Total	Real Lm	Code	
SW 2700-3200-4000	80	11.6	26.4	1488	14	
					34	
					60	DU
					E3	OU
					J6	XB
					Z5	

XB	Casambi	220-240V	50-60Hz
DU	DALI-2	100-277V	50-60Hz
OU	ON-OFF	100-277V	50-60Hz

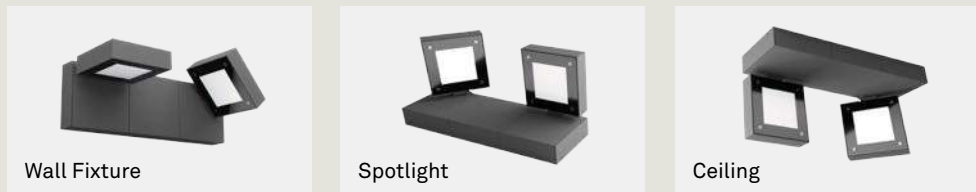

nicht inklusive / Non incluso	
Verkettungszubehör Leuchtenkopf extra weiß / Access. extra di collegamento in serie testa bianco	71-E235-14-00
Verkettungszubehör Leuchtenkopf extra schwarz / Access. extra di collegamento in serie testa nero	71-E235-60-00
Verkettungszubehör Leuchtenkopf extra hellgrau / Access. extra di collegamento in serie testa grigio chiaro	71-E235-34-00
Verkettungszubehör Leuchtenkopf extra braun / Access. extra di collegamento in serie testa marrone	71-E235-J6-00
Verkettungszubehör Leuchtenkopf tannengrün / Access. extra di collegamento in serie testa verde abete	71-E235-E3-00
Verkettungszubehör Leuchtenkopf extra gold / Access. extra di collegamento in serie testa dorato	71-E235-DL-00
Verkettungszubehör Leuchtenkopf extra grau / Access. extra di collegamento in serie testa grigio	71-E235-Z5-00

MODIS

Modis Opal Wall Fixture/Spotlight/ Ceiling



IP	66
----	----

IK	10
----	----

LOW	FLICKER
-----	---------

180°

350°



SEA SIDE	SUITABLE
----------	----------

BREEAM

SWITCH CCT	SW 2700-3200-4000
------------	-------------------



14* 34* 60* DL* E3* J6* Z5*

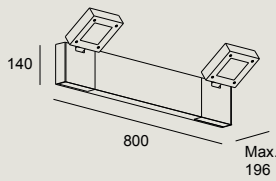

LED						
K	CRI	W LED	W Total	Real Lm	Code	
					14	
					34	
					60	DU
SW 2700-3200-4000	80	11.6	26.4	1488	05-E064 -	DL - OU
						E3 XB
						J6
						Z5

XB	Casambi	220-240V	50-60Hz
DU	DALI-2	100-277V	50-60Hz
OU	ON-OFF	100-277V	50-60Hz



nicht inklusive / Non incluso		
Verkettungszubehör Leuchtenkopf extra weiß / Access. extra di collegamento in serie testa bianco		71-E235-14-00
Verkettungszubehör Leuchtenkopf extra schwarz / Access. extra di collegamento in serie testa nero		71-E235-60-00
Verkettungszubehör Leuchtenkopf extra hellgrau / Access. extra di collegamento in serie testa grigio chiaro		71-E235-34-00
Verkettungszubehör Leuchtenkopf extra braun / Access. extra di collegamento in serie testa marrone		71-E235-J6-00
Verkettungszubehör Leuchtenkopf tannengrün / Access. extra di collegamento in serie testa verde abete		71-E235-E3-00
Verkettungszubehör Leuchtenkopf extra gold / Access. extra di collegamento in serie testa dorato		71-E235-DL-00
Verkettungszubehör Leuchtenkopf extra grau / Access. extra di collegamento in serie testa grigio		71-E235-Z5-00

nicht mitgeliefertes allgemeines Zub.	Access. comuni non inclusi	
Blende weiß	Visiera bianca	71-E234-14-00
Blende hellgrau	Visiera grigio chiaro	71-E234-34-00
Blende schwarz	Visiera nera	71-E234-60-00
Blende gold	Visiera dorata	71-E234-DL-00
Blende tannengrün	Visiera verde abete	71-E234-E3-00
Blende braun	Visiera marrone	71-E234-J6-00
Blende grau	Visiera grigia	71-E234-Z5-00

*Fragen Sie unser Verkaufsteam nach den Lieferbedingungen.
Consultare i termini e le condizioni di consegna al nostro team commerciale.



OUTDOOR STRAHLER / PROIETTORI

MODIS

Modis Optics Wall Fixture/Spotlight/ Ceiling



Codebeispiel / Esempio di codice: AS11-18V9S3OUZ5

Model	W	K/ Cri/ Real lm	Optics	Source	Finishes
AS11 - 	18 18,3W	V9 2700K CRI90/1301 lm	S3 16°	OU ON-OFF 100-277V 50-60Hz	Z5 ●
		W9 3000K CRI90/1301 lm	M3 33°	DS DALI-2 220-240V 50-60Hz	14* ○
		X9 4000K CRI90/1301 lm	F1 48°	XB CASAMBI 220-240V 50-60Hz	60* ●
					34* ●
					J6* ●
					E3* ●
					DL* ●

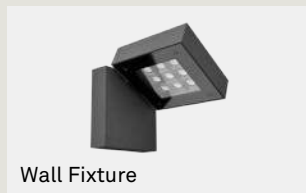

nicht inklusive / Non incluso

Pflock 235 mm / Paletto 235mm

71-9997-05-05

Pflock 302mm / Paletto 302mm

71-9998-05-05

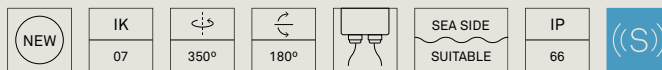

Codebeispiel / Esempio di codice: AS12-37V9S3OUZ5

Model	W	K/ Cri/ Real lm	Optics	Source	Finishes
AS12 - 	37 36,6W	V9 2700K CRI90/2602 lm	S3 16°	OU ON-OFF 100-277V 50-60Hz	Z5* ●
		W9 3000K CRI90/2602 lm	M3 33°	DS DALI-2 220-240V 50-60Hz	14* ○
		X9 4000K CRI90/2602 lm	F1 48°	XB CASAMBI 220-240V 50-60Hz	60* ●
					34* ●
					J6* ●
					E3* ●
					DL* ●

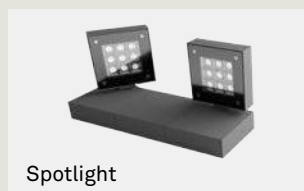

nicht inklusive / Non incluso

Verkettungszubehör Leuchtenkopf extra weiß / Access. extra di collegamento in serie testa bianco

71-E235-14-00

Verkettungszubehör Leuchtenkopf extra schwarz / Access. extra di collegamento in serie testa nero

71-E235-60-00

Verkettungszubehör Leuchtenkopf extra hellgrau / Access. extra di collegamento in serie testa grigio chiaro

71-E235-34-00

Verkettungszubehör Leuchtenkopf extra braun / Access. extra di collegamento in serie testa marrone

71-E235-J6-00

Verkettungszubehör Leuchtenkopf tannengrün / Access. extra di collegamento in serie testa verde abete

71-E235-E3-00

Verkettungszubehör Leuchtenkopf extra gold / Access. extra di collegamento in serie testa dorato

71-E235-DL-00

Verkettungszubehör Leuchtenkopf extra grau / Access. extra di collegamento in serie testa grigio

71-E235-Z5-00

*Fragen Sie unser Verkaufsteam nach den Lieferbedingungen.

Consultare i termini e le condizioni di consegna al nostro team commerciale.

MODIS

Modis Optics Wall Fixture/Spotlight/ Ceiling

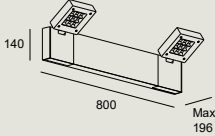

Codebeispiel / Esempio di codice: AS13-37V9S30UZ5

Model	W	K/ Cri/ Real lm	Optics	Source	Finishes
AS13 - 	37 36,6W	V9 2700K CRI90/2602 lm	S3 16°	OU ON-OFF 100-277V 50-60Hz	Z5
		W9 3000K CRI90/2602 lm	M3 33°	DS DALI-2 220-240V 50-60Hz	14*
		X9 4000K CRI90/2602 lm	F1 48°	XB CASAMBI 220-240V 50-60Hz	60* 34* J6* E3* DL*



nicht inklusive / Non incluso	
Verkettungszubehör Leuchtenkopf extra weiß / Access. extra di collegamento in serie testa bianco	71-E235-14-00
Verkettungszubehör Leuchtenkopf extra schwarz / Access. extra di collegamento in serie testa nero	71-E235-60-00
Verkettungszubehör Leuchtenkopf extra hellgrau / Access. extra di collegamento in serie testa grigio chiaro	71-E235-34-00
Verkettungszubehör Leuchtenkopf extra braun / Access. extra di collegamento in serie testa marrone	71-E235-J6-00
Verkettungszubehör Leuchtenkopf tannengrün / Access. extra di collegamento in serie testa verde abete	71-E235-E3-00
Verkettungszubehör Leuchtenkopf extra gold / Access. extra di collegamento in serie testa dorato	71-E235-DL-00
Verkettungszubehör Leuchtenkopf extra grau / Access. extra di collegamento in serie testa grigio	71-E235-Z5-00

nicht mitgeliefertes allgemeines Zub. Access. comuni non inclusi		
Blende weiß Visiera bianca		71-E234-14-00
Blende hellgrau Visiera grigio chiaro		71-E234-34-00
Blende schwarz Visiera nera		71-E234-60-00
Blende gold Visiera dorata		71-E234-DL-00
Blende tannengrün Visiera verde abete		71-E234-E3-00
Blende braun Visiera marrone		71-E234-J6-00
Blende grau Visiera grigia		71-E234-Z5-00

*Fragen Sie unser Verkaufsteam nach den Lieferbedingungen.
Consultare i termini e le condizioni di consegna al nostro team commerciale.



OUTDOOR STRAHLER / PROIETTORI



Thor

BODY MAT	DIF MAT		50000h
AISI316	GLA		L80 B20



Öffnungsoptionen Opzioni di apertura

Dieses Sortiment von Niederspannungsprojektoren hat ein sehr zurückhaltendes und geradliniges Design. Das Produkt besteht vollständig aus AISI316-Edelstahl und kann in feuchten Umgebungen oder sogar direkt am Meer installiert werden. Ideal zur Akzentbeleuchtung im Garten.

Questa collezione di proiettori a bassa tensione ha un design molto contenuto e pulito. Fabbricati interamente in acciaio inossidabile AISI316, questi apparecchi possono essere installati in ambienti umidi, incluso sul lungomare. Ideale per favorire l'illuminazione d'accento, nei giardini.

Thor bietet hochwertige Optiken und Materialien. Alle Versionen haben als Neuheit zwei neue Öffnungswinkel, wobei in der kleinen Größe Spot -12°- bis Ultra Flood -50°- und in den übrigen Größen Extra Spot -15°- bis Ultra Flood -50°- zur Auswahl stehen.

Thor è dotato di ottiche e materiali di alta qualità. Come novità, tutte le versioni hanno due nuovi angoli di apertura, potendo così scegliere tra Spot -12°- a Ultra Flood -50°- nella misura piccola e da Extra Spot -15°- a Ultra Flood -50°- nel resto di misurazioni.

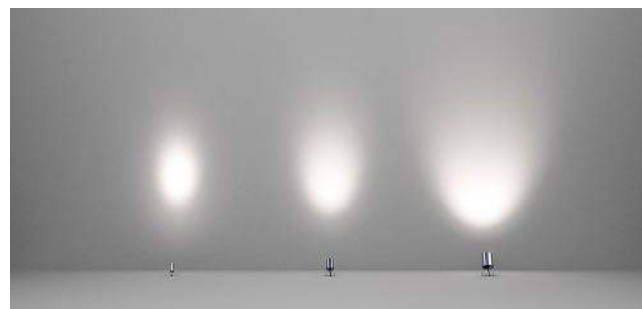

Einfache Installierung Installazione facile

Durch den 24-V-Betrieb und die Ausstattung aller Modelle mit einem externen Kabel wird eine schnelle und zuverlässige Installation gewährleistet.

Il funzionamento a 24V ed il fatto che tutti i modelli includano un cavo esterno, velocizza e garantisce una buona installazione.



Smart-Funktion:
Zeitprogrammierung
Funzionalità Smart:
Programmazione in base
all'orario

Da er Smart Compatible ist und mit dem entsprechenden Verbindungszubehör ausgestattet ist, können diese Leuchten über eine konnektive Lösung gesteuert werden, z. B. durch Ein-/Aus-schalten abhängig vom Sonnenauf- und Sonnenuntergang. Essendo un modello Smart Compatible, incorporando il corrispondente accessorio di connessione, si può integrare il controllo di questi apparecchi all'interno di una funzionalità connettiva. Ad esempio, il controllo della loro accensione a seconda dell'alba e del tramonto.

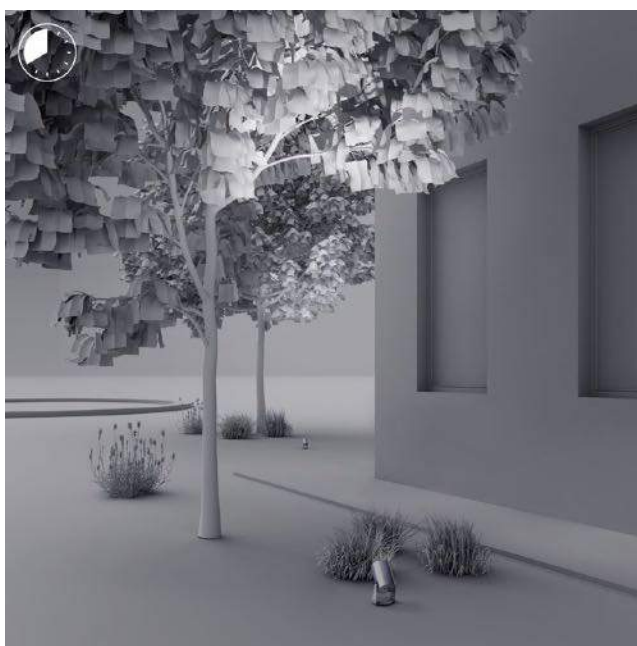

Intensitätsoptionen Opzioni di intensità

Die größere Version verfügt über eine Option mit einstellbarer Intensität, um die Anforderungen aller Projekte zu erfüllen.
La versione più grande ha un'opzione di intensità regolabile per adattarsi a tutti i progetti.



THOR

IP	IK	3			SEA SIDE	
66	02	MacAdam	90°	2 m	SUITABLE	ON-OFF

CA

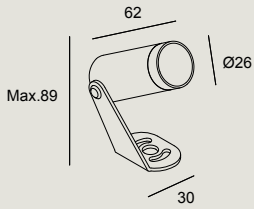

LED						
K	CRI	W LED	W Total	Real Lm	Optics	Code
3000	80	2	4.1	154	Spot 19°	05-E007
3000	80	2	4.1	169	Medium 33°	05-E152 - CA - CL
3000	80	2	4.1	138	Flood 52°	05-E008

24-48 VDC

nicht inklusive / Non incluso	
IP68-Stecker mit 6 Eingängen Connettori IP68 a 6 ingressi	71-9199-05-05
IP67-Stecker mit 3 Eingängen Connettori IP67 a 3 ingressi	71-9262-05-05
IP68- Antikondensationsstecker mit 2 Eingängen Connettori IP68 con valvola anticondensa a 2 ingressi	71-E112-00-00
IP68- Antikondensationsstecker mit 4 Eingängen Connettori IP68 con valvola anticondensa a 4 ingressi	71-E122-00-00
Erdbefestigungsspieß Picchetto di fissaggio a terra	71-E143-05-05

05-E007 05-E152 05-E008	IP		u. min	u. max	CODE
	IP68	ON-OFF	1	4	71-E101-05-05
	IP67	ON-OFF	1	13	71-E159-00-00
	Optional IP66 IK09 box (300x200x105mm)				71-E100-00-00

① P. 946

IP	IK	2			SEA SIDE		BREEAM
66	02	MacAdam	90°	2 m	SUITABLE	ON-OFF	

CA

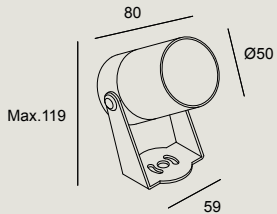

LED						
K	CRI	W LED	W Total	Real Lm	Optics	Code
3000	80	4.5	4.8	290	Spot 14°	05-E009
3000	80	4.5	4.8	341	Medium 26°	05-E153 - CA - CL
3000	80	4.5	4.8	352	Flood 49°	05-E010

24-48 VDC

nicht inklusive / Non incluso	
IP68-Stecker mit 6 Eingängen Connettori IP68 a 6 ingressi	71-9199-05-05
IP67-Stecker mit 3 Eingängen Connettori IP67 a 3 ingressi	71-9262-05-05
IP68- Antikondensationsstecker mit 2 Eingängen Connettori IP68 con valvola anticondensa a 2 ingressi	71-E112-00-00
IP68- Antikondensationsstecker mit 4 Eingängen Connettori IP68 con valvola anticondensa a 4 ingressi	71-E122-00-00
Erdbefestigungsspieß Picchetto di fissaggio a terra	71-E143-05-05

05-E009 05-E153 05-E010	IP		u. min	u. max	CODE
	IP68	ON-OFF	1	4	71-E101-05-05
	IP67	ON-OFF	1	11	71-E159-00-00
	Optional IP66 IK09 box (300x200x105mm)				71-E100-00-00

① P. 946

THOR

IP 66	IK 05	2 MacAdam	 90°	 2 m	SEA SIDE SUITABLE	 PWM	BREEAM	
----------	----------	--------------	---------	---------	----------------------	---------	--------	--

CA

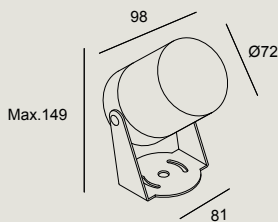

LED						
K	CRI	W LED	W Total	Real Lm	Optics	Code
3000	80	8.4	9.4	758	Spot 16°	05-E011
3000	80	8.4	9.4	675	Medium 29°	05-E154 - CA - CL
3000	80	8.4	9.4	812	Flood 52°	05-E013

24VDC

nicht inklusive / Non incluso	
IP68-Stecker mit 6 Eingängen Connettore IP68 a 6 ingressi	71-9199-05-05
IP67-Stecker mit 3 Eingängen Connettore IP67 a 3 ingressi	71-9262-05-05
Pflock 235 mm Paletto 235mm	71-9997-05-05
Pflock 302mm Paletto 302mm	71-9998-05-05
IP68- Antikondensationsstecker mit 2 Eingängen Connettore IP68 con valvola anticondensa a 2 ingressi	71-E112-00-00
IP68- Antikondensationsstecker mit 4 Eingängen Connettore IP68 con valvola anticondensa a 4 ingressi	71-E122-00-00

Smart Compatible-Zub. / Access. Smart Compatibile
71-A242-00-00 Driver Casambi PWM 1ch IP66

05-E011 05-E154 05-E013	IP		u. min	u. max	CODE
	IP68	ON-OFF	1	2	71-E101-05-05
		ON-OFF	1	9	71-6341-00-00
	IP67	DALI	1	11	71-E099-00-00
		0-10V	1	11	71-E097-00-00
	Optional IP66 IK09 box (300x200x105mm)				71-E100-00-00

P. 946



Zoom

BODY MAT	DIF MAT		50000h	3
AL	PMMA		L80 B20	MacAdam



Zoom ist eine besonders kompakte Strahler-Kollektion, die speziell für die Beleuchtung von Landschaftsteilen oder Architekturobjekten mit präzise ausgerichteter Abstrahlung entwickelt wurde. Der Lichtstrahl dieser praktischen und vielseitigen Leuchtenkollektion lässt sich mit geringem Aufwand und ohne Werkzeug per Hand einstellen. Die Rundblende sorgt zudem für maximalen visuellen Komfort und reduziert die Blendwirkung. Erhältlich in zwei Leistungsstufen und mit drei Farbtemperaturen (2700 K, 3000 K und 4000 K).

Zoom è una collezione di proiettori molto compatti, appositamente progettata per illuminare qualsiasi parte del paesaggio o dell'architettura con grande precisione del fascio di luce. Gli apparecchi Zoom consentono di regolare rapidamente il fascio di luce, manualmente e senza bisogno di attrezzi, e questa caratteristica li rende estremamente utili e versatili. Inoltre, la sua visiera circolare massimizza il comfort visivo e riduce l'abbagliamento. È disponibile in 2 potenze e 3 temperature di colore (2700K, 3000K e 4000K).

Vielfältige Anwendung Molteplici applicazioni

Die Zoom-Strahler können je nach Anforderung des Einbauorts mit zwei verschiedenen Sockeltypen kombiniert werden. Für die Aufstellung der Leuchte auf Grasflächen oder sonstigen weichen Untergründen ist der Erdeinbausatz geeignet. Er besteht aus einem Pfosten und einem wasserdichten Gehäuse mit ebenfalls wasserdichtem Anschluss. Für die Montage auf harten Oberflächen wie Wänden, Decken oder Fußböden ist der Aufbausockelsatz erhältlich. Er wird mit eingebautem Treiber und den Ansteuerungsoptionen EIN-AUS oder DALI geliefert.

I proiettori Zoom possono essere combinati con 2 tipi di base, in funzione del luogo di installazione. Per installazioni su prato o su un'altra superficie morbida simile, è necessario il Kit di base per semi-interrare, che è composto da un picchetto e da un dispositivo stagno con connessione stagna inclusa. Per installazioni su superfici dure, come pareti, tetti o pavimenti, è necessario il Kit di base per superficie, composto da una base con driver incluso all'interno, disponibile in ON-OFF e DALI.

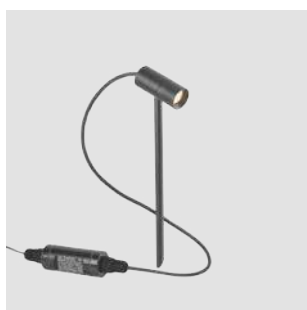

Base-Satz für halbvergrabene Einbau
Kit base per applicazione semi-interrata



Base-Satz für den Aufbau
Kit di base per applicazione di superficie



Base-Satz Dali für den Aufbau
Kit di base per applicazione di superficie Dali

**Verschiedene
Farbtemperaturen**
Diverse temperature di colore

Zoom ist in 3 Farbtemperaturen (2700 K, 3000 K und 4000 K) verfügbar, um die Anpassung an alle Projekte zu ermöglichen. Zoom è disponibile in 3 temperature di colore (2700K, 3000K e 4000K) per adattarsi ad ogni tipo di progetto.

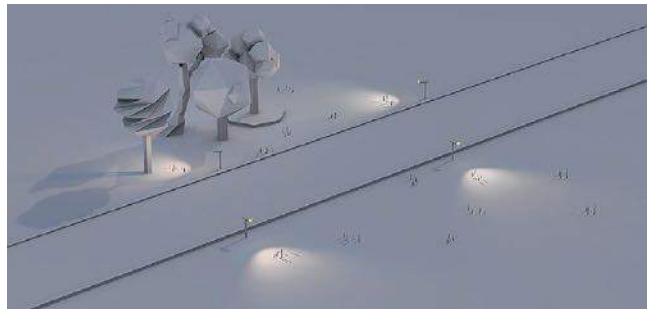
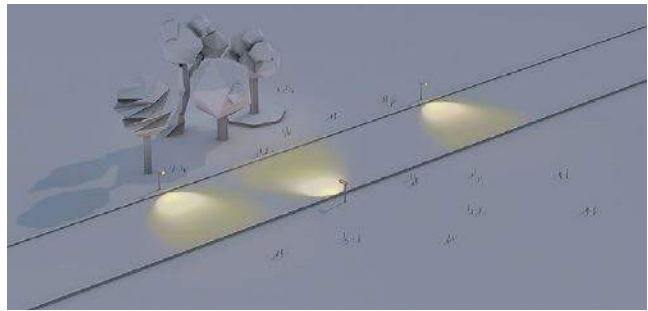
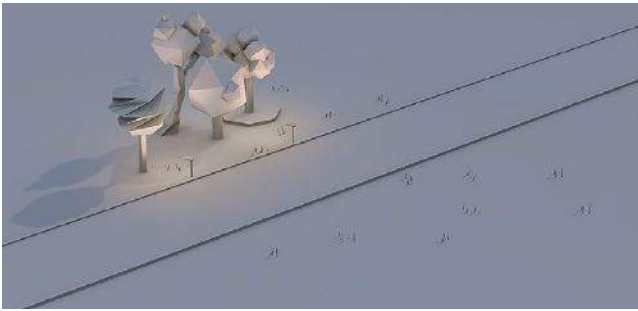

Manuelle Öffnungseinstellung
Regolazione manuale apertura

Der Öffnungswinkel lässt sich dank des manuellen Zoom-Systems ohne Werkzeug einstellen. Durch einfaches Vorwärts- oder Rückwärtsbewegen des Leuchtenkopfs kann der Abstrahlwinkel vergrößert oder verkleinert werden. Mitgeliefert werden zwei Leuchtenköpfe, einer davon mit Linse zum Umstellen vom Spot- auf den Medium-Winkel, und der zweite ohne Linse zum Umstellen vom Medium- auf den Flood-Winkel. Die Möglichkeit, den Lichtstrahl umzustellen, macht Zoom zu einer einzigartigen Kollektion, die sich besonders gut an das natürliche Wachstum der Vegetation anpassen lässt.

Dispone di un angolo di apertura regolabile, grazie al sistema zoom manuale che non richiede l'uso di attrezzi. Per modificare il fascio di luce, e renderlo più stretto o più largo, è sufficiente muovere la testa dell'apparecchio in avanti o all'indietro. Sono incluse 2 teste, una con lente per passare da angolo Spot a Medium; e l'altra senza lente per passare da angolo Medium a Flood. Questa prestazione di cambio del fascio di luce rende Zoom una collezione unica, particolarmente utile per adattarsi facilmente alla crescita naturale della vegetazione.



Spot / Flood
Cabeça com lupa|Cabeça sem
lupa|Spot/Flood

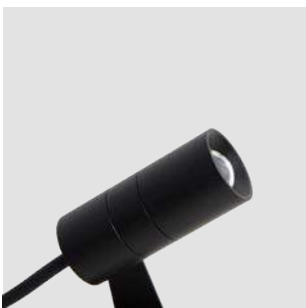

Kopf mit Linse
Testa con lente

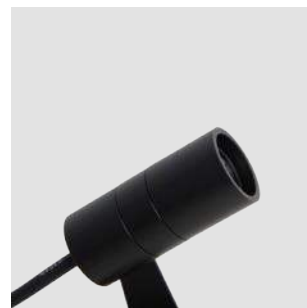
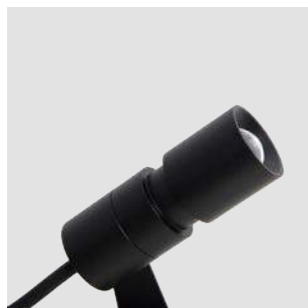

Kopf ohne Linse
Testa senza lente

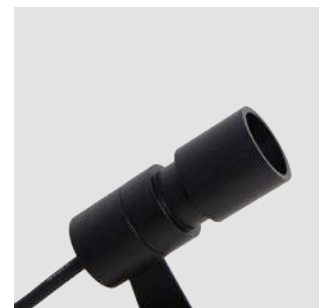

ZOOM



05 ●

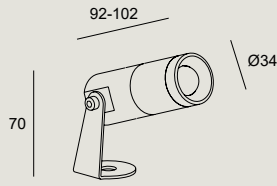

LED						
K	CRI	W LED	Real Lm	Optics	Code	
2700	80	3.8	270	Zoom 7° - 105°	05-E060 - 05 - CK	
3000	80	3.8	270	Zoom 7° - 105°	05-E060 - 05 - CL	
4000	80	3.8	270	Zoom 7° - 105°	05-E060 - 05 - CM	

⚡ 3V Max. 1200mA

nicht inklusive / Non incluso		
Befestigungssystem auf Pergolen für bis zu 3 Strahler Ancoraggio per pergolati fino a 3 proiettori		71-9746-05-05
Pflock 235 mm Paletto 235mm		71-9997-05-05
Pflock 302mm Paletto 302mm		71-9998-05-05
Verlängerungskabel mit 300 + 500 mm Länge für Wand, Boden und Rasen Stensione di 300+500mm per parete, pavimento e prato..		71-E052-Z5-Z5
Erdeinbausatz mit ON-OFF-Treiber Kit per interrare con driver ON-OFF		71-E225-05-05
Aufbausatz mit ON-OFF-Treiber Kit da superficie con driver ON-OFF		71-E364-05-05



05 ●

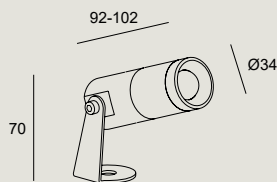

LED						
K	CRI	W LED	Real Lm	Optics	Code	
2700	80	8.4	428	Zoom 7° - 105°	05-E061 - 05 - CK	
3000	80	8.4	428	Zoom 7° - 105°	05-E061 - 05 - CL	
4000	80	8.4	428	Zoom 7° - 105°	05-E061 - 05 - CM	

⚡ 12V Max. 700mA

nicht inklusive / Non incluso		
Befestigungssystem auf Pergolen für bis zu 3 Strahler Ancoraggio per pergolati fino a 3 proiettori		71-9746-05-05
Pflock 235 mm Paletto 235mm		71-9997-05-05
Pflock 302mm Paletto 302mm		71-9998-05-05
Aufbausatz mit ON-OFF-Treiber Kit da superficie con driver ON-OFF		71-E039-05-05
Aufbausatz mit DALI-Treiber Kit da superficie con driver DALI		71-E041-05-05
Verlängerungskabel mit 300 + 500 mm Länge für Wand, Boden und Rasen Stensione di 300+500mm per parete, pavimento e prato..		71-E052-Z5-Z5
Erdeinbausatz mit ON-OFF-Treiber Kit per interrare con driver ON-OFF		71-E226-05-05

mitgeliefertes allgemeines Zub.
Access. comuni inclusi

Röhrenförmiger Blendschutz
Visiera tubolare antiabbagliante





Micro

BODY MAT	DIF MAT		50000h	2
AL	GLA		L80 B20	MacAdam



Umfangreiches Angebot an Zubehör und Filtern Ampia gamma di accessori e filtri

Dank des minimalistischen röhrenförmigen Designs und ihrer speziellen Lackierung fügt sich diese Strahlerkollektion perfekt in die natürliche Umgebung eines Außenbereichs ein. Einzigartig auf dem Markt und für den Benutzer flexibel anpassbar, erfüllt dieser Strahler universelle Beleuchtungsaufgaben. Er kann auf dem Boden, der Wand oder an der Decke montiert werden.

Grazie alla sua geometria tubolare minimalista e alla sua finitura marrone, questa collezione di proiettori si fonde perfettamente con gli elementi naturali di uno spazio esterno. Unici sul mercato, questi modelli sono accessibili e manipolati dall'utente, consentendo di configurarli facilmente per ottenere un design illuminotecnico ottimale. Possono essere installati a pavimento, a parete e a soffitto.

Die Kollektion bietet zwei Strahlergrößen mit unterschiedlichen Abstrahlwinkeln (15° und 24° sowie 15° und 38°) und verschiedene Zubehörteile, die sich leicht austauschen lassen, wie ein Visier zur Verbesserung des visuellen Komforts und zur Vermeidung von Blendung. Inklusive drei Farbfilter: ein grüner zur Akzentuierung von Bepflanzungen, ein gelber für eine angenehme warme Beleuchtung und ein mattierter für diffuse Beleuchtungsaufgaben.

La collezione propone diversi accessori, come due riflettori facilmente intercambiabili con diversi angoli di apertura, una visiera per migliorare il comfort visivo ed evitare l'abbagliamento, e tre filtri colorati: uno verde per enfatizzare la vegetazione, giallo per inondare il fascio luminoso di un tono molto caldo e satinato per filtrare i limiti dell'alone di luce, creando un effetto diffuso. Come accessori opzionali, ha un braccio di prolunga che si fissa al palo e che permette di posizionare il proiettore a tre diverse altezze, oltre un adattatore se si vuole posizionarlo su una superficie piana.

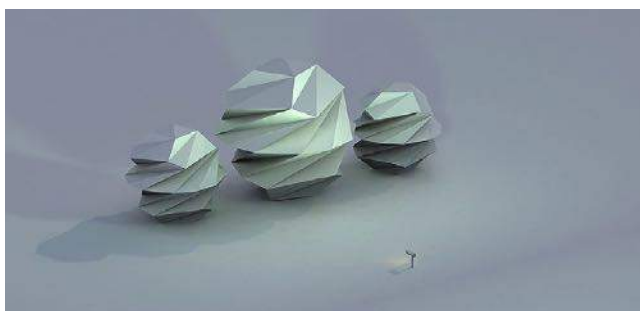

Lichteffekt mit grünem Filter.
Effetto di luce con filtro verde.



Lichtwirkung mit 24°-Reflektor ohne Filter
Effetto di luce con riflettore di 24°, senza filtri.

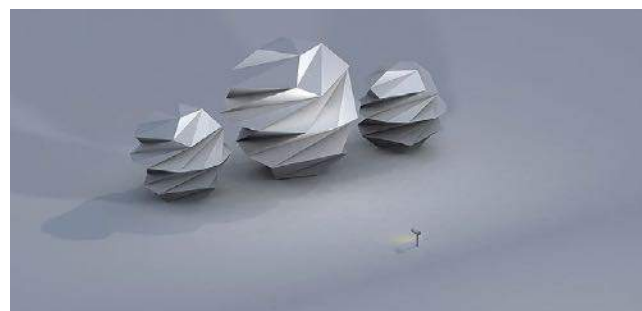

Lichteffekt mit mattiertem Diffusor.
Effetto di luce con filtro diffusore.

Hohe Anpassbarkeit und visueller Komfort
Grande adattabilità e comfort visivo

Mit einem um $\pm 90^\circ$ schwenkbaren Leuchtengehäuse zur Ausrichtung des Lichtstrahls, einem Visier zur Erhöhung des visuellen Komforts, einem Erdspieß und 2,5 m Zuleitung für einen flexiblen Einsatz.

Dotato di un corpo regolabile di $\pm 90^\circ$ per focalizzare il fascio di luce, include anche una visiera per migliorare il comfort visivo, un picchetto per il fissaggio a terra e 2,5 m di cavo per garantire la posizione desiderata.



Maximale Lebensdauer
Massima durabilità

Micro besteht vollständig aus eloxiertem Aluminium, was eine perfekte Wärmeableitung ermöglicht und die Lebensdauer des Produkts erhöht.

Micro è interamente realizzato in alluminio anodizzato, che facilita la perfetta dissipazione del calore e massimizza la vita utile del prodotto.



Ausleger
Braccio di estensione

Als optionales Zubehör ist ein Ausleger erhältlich. Dieser ermöglicht es, den Strahler in drei verschiedenen Abständen zur Wand oder zum Boden zu montieren. Zusätzlich gibt es einen Adapter, um auf einer ebenen Fläche montiert werden zu können.

Tra gli accessori opzionali, offre un braccio di prolunga che viene fissato al picchetto, consentendo di posizionare il proiettore a tre diverse altezze ed un adattatore, che permette posizionarlo su una superficie piana.

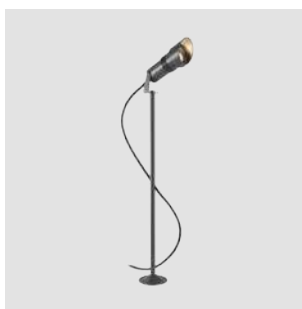

MICRO

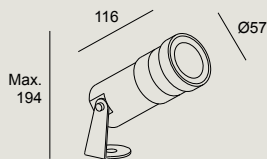

IP	IK	±90°	2.5 m	SEA SIDE SUITABLE	ON-OFF	BREEAM
65	04					

J6 Z5

LED						
K	CRI	W LED	W Total	Real Lm	Optics	Code
3000	80	3	4.7	343	Spot 17°	05-9881 - J6 - Z5 - CL
100-240V		50-60Hz				

inklusive / Incluso

Blende
Visiera

Erdspeiß
Picchetto

15° und 38° Reflektoren
Riflettori 15° e 38°

Austauschbare Filter grün und gelb
Filtri intercambiabili verde e giallo

Diffusor-Filter
Filtro diffusore

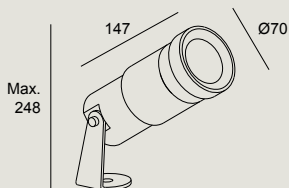

IP	IK	±90°	2.5 m	SEA SIDE SUITABLE	ON-OFF	BREEAM
66	04					

J6 Z5

LED						
K	CRI	W LED	W Total	Real Lm	Optics	Code
3000	80	6	7.5	643	Spot 16°	05-9988 - J6 - Z5 - CL
100-240V		50-60Hz				

inklusive / Incluso

Blende
Visiera

Erdspeiß
Picchetto

15° und 38° Reflektoren
Riflettori 15° e 38°

Austauschbare Filter grün und gelb
Filtri intercambiabili verde e giallo

Diffusor-Filter
Filtro diffusore

nicht mitgeliefertes allgemeines Zub.
Access. comuni non inclusi

IP68-Stecker mit 6 Eingängen Connettore IP68 a 6 ingressi	71-9199-05-05
IP67-Stecker mit 3 Eingängen Connettore IP67 a 3 ingressi	71-9262-05-05
Befestigungssystem auf Pergolen für bis zu 3 Strahler Ancoraggio per pergolati fino a 3 proiettori	71-9746-05-05
Befestigungszubehör zur Montage am Mast oder Baum Fissaggio per colonne o alberi	71-9999-Z5-Z5
Verlängerungskabel mit 300 + 500 mm Länge für Wand, Boden und Rasen Stensione di 300+500mm per parete, pavimento e prato..	71-E052-J6-J6
Verlängerungskabel mit 300 + 500 mm Länge für Wand, Boden und Rasen Stensione di 300+500mm per parete, pavimento e prato..	71-E052-Z5-Z5
IP68- Antikondensationsstecker mit 2 Eingängen Connettore IP68 con valvola anticondensa a 2 ingressi	71-E112-00-00
IP68- Antikondensationsstecker mit 4 Eingängen Connettore IP68 con valvola anticondensa a 4 ingressi	71-E122-00-00

Helio AISI316

DIF MAT
GLA



BODY MAT	IP	IK			SEA SIDE
AISI316	67	10	360°	±45°	SUITABLE

CA

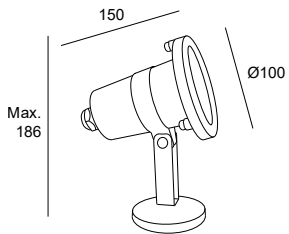

GU10	
W max. 35	Code 05-9310 - CA - 37

inklusive / Incluso
Erdspieß Picchetto

Helio Aluminium

DIF MAT
GLA



BODY MAT	IP	IK		SEA SIDE
AL	65	10	±90°	SUITABLE

05 ● 34 ●

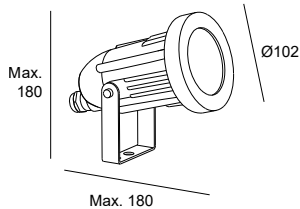

GU10	
W	Code
max. 35	05-9640 - 05 - 34 - 37

inklusive / Incluso
Erdspieß Picchetto



nicht inklusive / Non incluso	
Befestigungssystem auf Pergolen für bis zu 3 Strahler Ancoraggio per pergolati fino a 3 proiettori	71-9746-05-05
Befestigungszubehör zur Montage am Mast oder Baum Fissaggio per colonne o alberi	71-9999-Z5-Z5
Socket für Kabel von Ø 6 mm bis Ø 13,5 mm Base per cavi da Ø6mm a Ø13,5mm	71-E016-Z5-Z5



Esparta

BODY MAT	DIF MAT		IP	IK		
AL	GLA		65	06	2.5 m	±90°



IP	IK			SEA SIDE
65	06	±90°	2.5 m	SUITABLE

Z5 ●

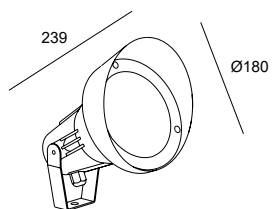

E27/PAR-38	
W	Code
max. 80	05-9789 - Z5 - 37

inklusive / Incluso
Erdspieß Picchetto

nicht inklusive / Non incluso
Verlängerungskabel mit 300 + 500 mm Länge für Wand, Boden und Rasen 71-E052-Z5-Z5
Stensione di 300+500mm per parete, pavimento e prato..

Suv

BODY MAT	DIF MAT		IP	IK	50000h	2				BREEAM
AL	GLA		65	06	L80 B20	MacAdam	±90°	1 m	ON-OFF	



IP	IK			SEA SIDE		BREEAM
65	06	±90°	1 m	SUITABLE	ON-OFF	

Z5 ●

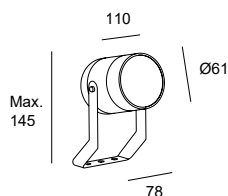

LED						
K	CRI	W LED	W Total	Real Lm	Optics	Code
3000	80	4.5	5.5	434	Medium 23°	05-E046 - Z5 - CL
		100-240V 50-60Hz				



	IP	IK			SEA SIDE		BREEAM
	65	06	±90°	1 m	SUITABLE	ON-OFF	

Z5 ●

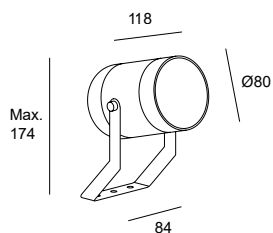

LED						
K	CRI	W LED	W Total	Real Lm	Optics	Code
3000	80	12.6	13.5	1294	Medium 29°	05-E057 - Z5 - CL
		100-240V 50-60Hz				

mitgeliefertes allgemeines Zub.
Access. comuni inclusi

Erdspieß
Picchetto

**nicht mitgeliefertes
allgemeines Zub.**
Access. comuni non inclusi

IP68-Stecker mit 6 Eingängen
Connettore IP68 a 6 ingressi **71-9199-05-05**

IP67-Stecker mit 3 Eingängen
Connettore IP67 a 3 ingressi **71-9262-05-05**

IP68- Antikondensationsstecker mit 2 Eingängen
Connettore IP68 con valvola anticondensa a 2 ingressi **71-E112-00-00**

IP68- Antikondensationsstecker mit 4 Eingängen
Connettore IP68 con valvola anticondensa a 4 ingressi **71-E122-00-00**



Unterwasserleuchten

Lucisommergibili

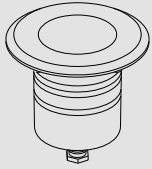

Aqua

592

Aqua Spotlight AISI 316



DIF MAT	BODY MAT	IP	IK		50000h	3		SEA SIDE	BREEAM
GLA	AISI316	68	10	±45°	L80 B20	MacAdam	2.5 m	SUITABLE	

CA

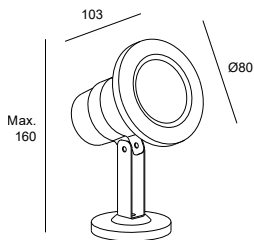

LED						
K	CRI	W LED	Real Lm	Optics	Code	
4000	80	5	311	Medium 24°	05-9889 - CA - CM	
12V AC/DC						

P. 940

inklusive / Incluso

Erdspieß
Picchetto



DIF MAT	BODY MAT	IP	IK			SEA SIDE
GLA	AISI316	68	10	±45°	2.5 m	SUITABLE

CA

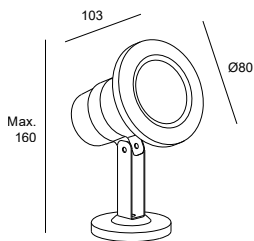

GU5.3	
W	Code
max. 35	05-9245 - CA - 37
12V 50-60Hz	

P. 940

inklusive / Incluso

Erdspieß
Picchetto

**nicht mitgeliefert
allgemeines Zub.**
Access. comuni non inclusi

IP68-Stecker mit 6 Eingängen
Connettore IP68 a 6 ingressi **71-9199-05-05**

IP67-Stecker mit 3 Eingängen
Connettore IP67 a 3 ingressi **71-9262-05-05**

IP68- Antikondensationsstecker mit 2 Eingängen
Connettore IP68 con valvola anticondensa a 2 ingressi **71-E112-00-00**

IP68- Antikondensationsstecker mit 4 Eingängen
Connettore IP68 con valvola anticondensa a 4 ingressi **71-E122-00-00**

Aqua Recessed AISI 316

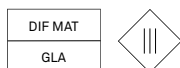

DIF MAT	BODY MAT	IP	IK	50000h	3			SEA SIDE	BREEAM
GLA	AISI316	68	08	L80 B20	MacAdam	1000 kg	5 m	SUITABLE	

CA

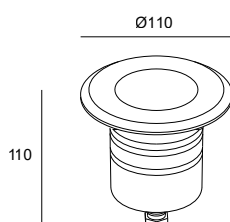

LED						
K	CRI	W LED	Real Lm	Optics	Code	
4000	80	5	313	Medium 24°	55-9792 - CA - CM	
12V AC/DC						

P. 940



DIF MAT	BODY MAT	IP	IK			SEA SIDE
GLA	AISI316	68	08	1000 kg	2.5 m	SUITABLE

CA

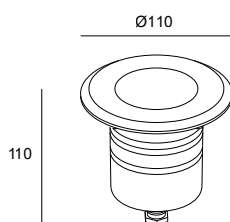

GU5.3		
W	Code	
max. 50	55-9245 - CA - 37	
12V 50-60Hz		

P. 940

mitgeliefertes allgemeines Zub. Unterputzdose
Access. comuni inclusi Cassetta da incasso

nicht mitgeliefertes allgemeines Zub.
Access. comuni non inclusi

IP68-Stecker mit 6 Eingängen Connettore IP68 a 6 ingressi	71-9199-05-05
IP67-Stecker mit 3 Eingängen Connettore IP67 a 3 ingressi	71-9262-05-05
IP68- Antikondensationsstecker mit 2 Eingängen Connettore IP68 con valvola anticondensa a 2 ingressi	71-E112-00-00
IP68- Antikondensationsstecker mit 4 Eingängen Connettore IP68 con valvola anticondensa a 4 ingressi	71-E122-00-00

Aqua Recessed PC



BODY MAT	IP	IK	50000h	3		SEA SIDE
PC,AL	68 (1m)	10	L80 B20	MacAdam	2,5 m	SUITABLE

14

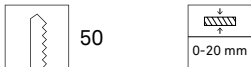
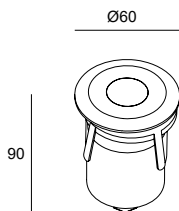

LED						
K	CRI	W LED	W Total	Real Lm	Optics	Code
4000	80	2.2	2.2	52	Flood 96°	55-9622 - 14 - CM
3V Max. 700mA						

inklusive / Incluso

- Unterputzdose
Cassetta da incasso
- Austauschbare farbige Filter
Filtri intercambiabili colorati
- Unterputz-Sockel
Base da incasso

nicht inklusive / Non incluso

- IP68-Stecker mit 6 Eingängen
Connettore IP68 a 6 ingressi **71-9199-05-05**
- IP67-Stecker mit 3 Eingängen
Connettore IP67 a 3 ingressi **71-9262-05-05**
- IP68- Antikondensationsstecker mit 2 Eingängen
Connettore IP68 con valvola anticondensa a 2 ingressi **71-E112-00-00**
- IP68- Antikondensationsstecker mit 4 Eingängen
Connettore IP68 con valvola anticondensa a 4 ingressi **71-E122-00-00**

55-9622	IP		u. min	u. max		CODE
				220-240V	110-127V	
	IP67	ON-OFF	2	4	4	71-E014-00-00
	IP68	DALI	1	13	6	71-E080-00-00
		0-10V	1	7	6	71-E081-00-00
	IP20	ON-OFF	1	7	5	71-3308-00-00
		DALI	1	8	6	71-6192-00-00
		0-10V	1	8	6	71-7710-00-00
	Optional IP66 IK09 box (300x200x105mm)					71-E100-00-00

P. 946



Deckeneinbauleuchten

Incassi a soffitto



Max

597

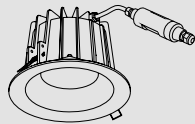

Dako

603

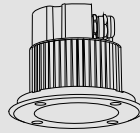

Gea

608



Max

BODY MAT	DIF MAT		50000h
AL	GLA		L80 B20



Video ansehen
Guarda il video

Ökologisches Design Ecodesign

Umfangreiches Zubehör Ampia gamma di accessori



Die Deckeneinbauleuchte der Familie Max ist in drei Formaten erhältlich: quadratisch, rund und tief rund. Auf diese Weise können Lösungen für jeden Beleuchtungsbedarf in Bereichen wie Terrassen oder Eingängen von Büros, Hotels oder Wohnräumen angeboten werden. Das Modell ist jetzt auch ganz individuell in allen von LEDS C4 angebotenen Farben erhältlich und wurde durch größere und leistungsstärkere Modelle ergänzt, die alle mit 3 Farbtemperaturen (2700K, 3000K, 4000K) und 4 verschiedenen Abstrahlwinkeln (8,6°, 17°, 27°, 50°) erhältlich sind, um allen Projekten gerecht zu werden. Als Ergänzung sind eine Wabenplatte und ein Filter zur Lichtstreuung für ovales Licht und quadratisches Licht erhältlich.

Il faretto da incasso della famiglia Max è disponibile in 3 formati: quadrato, rotondo e rotondo profondo per rispondere a qualsiasi esigenza di illuminazione in spazi come terrazze o portici di uffici, hotel o residenze. Può essere personalizzato in tutti i colori offerti dalla LEDS C4, in modelli più grandi e più potenti, tutti disponibili in 3 temperature (2700K, 3000K, 4000K) e in 4 diverse angolazioni (8,6°, 17°, 27°, 50°) per adattarsi a tutti i progetti. Inoltre, può essere completato con un pannello a nido d'ape e con filtri a luce diffusa, luce ovale o luce quadrata.

Sein Design erfüllt dank der Verwendung von austauschbaren LED-Modulen ökologische Parameter. Mit einem niedrigen Blendungswert von UGR >12 weist Max einen hohen Sehkomfort auf und bietet mit einer hohen Farbwiedergabe von CRI90.

Il suo design risponde a un parametro ecologico, grazie all'utilizzo di moduli led sostituibili. Dotato di un elevato comfort visivo contraddistinto da un UGR >12, Max offre un'elevata resa cromatica con un CRI90.



Die Kollektion beinhaltet eine große Auswahl an Zubehör wie einen elliptischen Diffusor, einen quadratischen Diffusor, ein Wabenraster und eine Weichzeichnerlinse.

La collezione dispone di un'ampia gamma di accessori quali diffusore ellittico, diffusore quadrato, pannello a nido d'ape e diffusore dell'alone.

- ① **Struktur**
Struttura
Downlight Trimless
Downlight Round
Downlight Square
- ② **Modul**
Modulo
Umweltfreundlich
austauschbare LED-Module
Moduli LED eco-progettati
per essere sostituiti
- ③ **Zubehör im
lieferumfang enthalten**
Accessori inclusi
Öffnungswinkel:
8,6° - 17° - 27° - 50°
Angoli di apertura:
8,6° - 17° - 27° - 50°
- ④ **Sonderzubehör**
Accessori opzionali
Elliptischer Diffusor
Diffusore ellittico
Quadratischer Diffusor
Diffusore quadrato
Wabendiffusor
Diffusore pannello a
nido d'ape
Lichthof-Diffusor
Diffusore dell'alone
- ⑤ **Abdichtung**
Chiusura
Hermetische Abdichtung
nach IP65
Chiusura ermetica per
garantire IP65

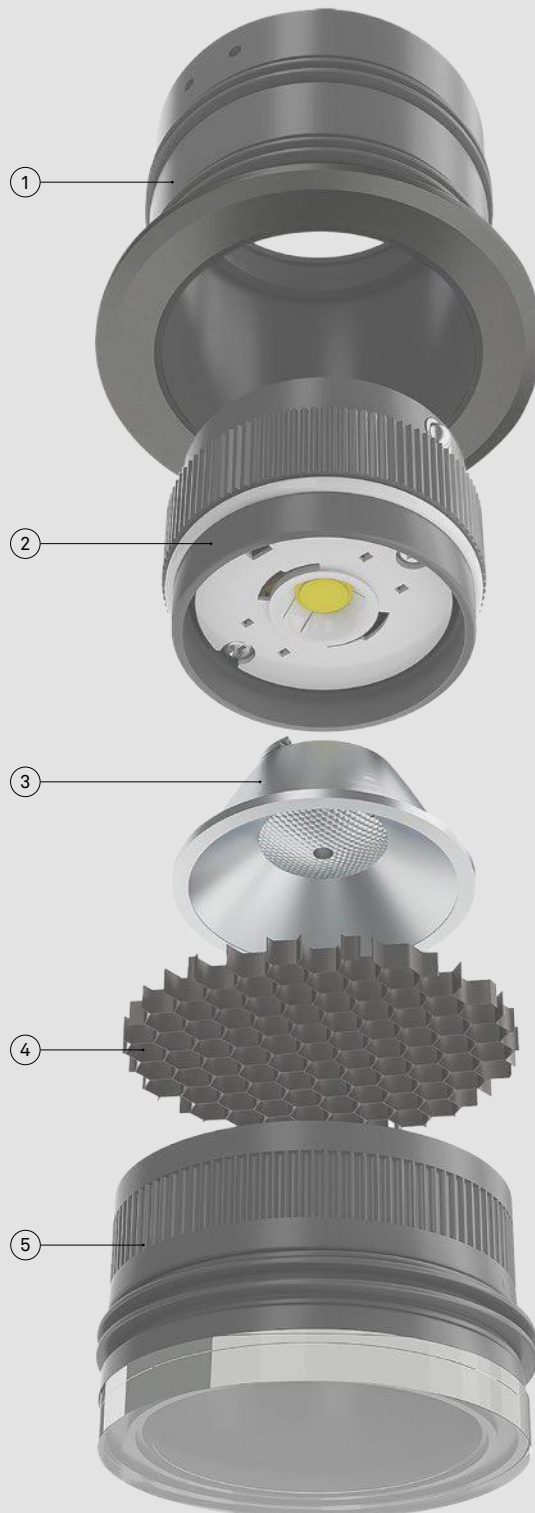



MAX

Max Downlight

BODY MAT
AL

DIF MAT
GLA













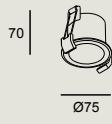



IK
10

☉
1 m

SEA SIDE
SUITABLE

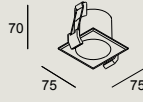
IP
66

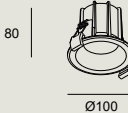
Codebeispiel / Esempio di codice: AI14-P4V9S1BBZ5

Model	W	K/ Cri/ Real lm	Optics	Source	Finishes
AI14 - Rund / Mit rahmen Rotondo / Con cornice ⌀ 65  	P4 4W	V9 2700K CRI90/286 lm	S1 9°	BB  12V Max. 350mA	Z5  14*  60*  34*  J6*  E3*  DL* 
		W9 3000K CRI90/286 lm			
		X9 4000K CRI90/286 lm			
AI15 - Quadratisch / Mit rahmen Quadrato / Con cornice ⌀ 65  	P7 6,5W	V9 2700K CRI90/519 lm	S2 17°	BB  18V Max. 350mA	
		W9 3000K CRI90/519 lm			
		X9 4000K CRI90/519 lm			
AI16 - Rund / zurückversetzt / mit Rahmen Rotondo / retrocesso / con cornice ⌀ 85  	P7 6,5W	V9 2700K CRI90/519 lm	S2 17°	BB  18V Max. 350mA	
		W9 3000K CRI90/519 lm			
		X9 4000K CRI90/519 lm			

AI11 AI12 AI13 AI14 AI15 AI16 AI17 AI18	IP 	u. min	u. max				Code
			P4 (8,6°)		P7 (17°/ 27°/ 50°)		
			220-240V	110-127V	220-240V	110-127V	
	ON-OFF	1	4	3	2	2	71-E079-00-00
	DALI	1	4	4	2	2	71-E083-00-00
	0-10V	1	4	4	2	2	71-E083-00-00
	ON-OFF	1	6	6	4	4	71-3542-00-00
	DALI	1	6	6	4	4	71-4706-00-00
	0-10V	1	6	6	4	4	71-4706-00-00
Optional IP66 IK09 box (300x200x105mm)							71-E100-00-00

ⓘ P. 946

nicht inklusive / Non incluso	
IP68-Stecker mit 6 Eingängen / Connettore IP68 a 6 ingressi	71-9199-05-05
IP67-Stecker mit 3 Eingängen / Connettore IP67 a 3 ingressi	71-9262-05-05
Unterputzdose / Scatola da incasso (AI16)	71-E354-00-00
Unterputzdose / Scatola da incasso (AI14, AI15)	71-E035-00-00
IP68- Antikondensationsstecker mit 2 Eingängen Connettore IP68 con valvola anticondensa a 2 ingressi	71-E112-00-00
5 Wabenraster / 5 pannelli a nido d'ape	71-E131-00-00
5 Lichtfilter für gestreute Lichtkegel / 5 filtri per l'emissione di luce diffusa	71-E133-00-00
5 Lichtfilter für quadratische Lichtkegel / 5 filtri per l'emissione di luce quadrata	71-E135-00-00
5 Lichtfilter für elliptische Lichtkegel / 5 filtri per emettere luce ellittica	71-E141-00-00

*Fragen Sie unser Verkaufsteam nach den Lieferbedingungen.





Consultare i termini e le condizioni di consegna al nostro team commerciale.

MAX

Max Downlight

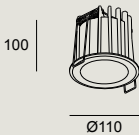
	BODY MAT AL	DIF MAT GLA		IK 10	2 MacAdam		SEA SIDE SUITABLE	IP 66
--	----------------	----------------	--	----------	--------------	--	----------------------	----------

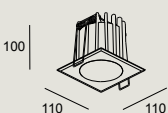
Codebeispiel / Esempio di codice: AT14-18V9S3BBZ5

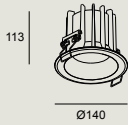
Model	W	K/ Cri/ Real lm	Optics	Source	Finishes
AT14 - Rund / Mit rahmen Rotondo / Con cornice ⌀ 65 0-70 mm  	18 17,3W	V9 2700K CRI90/1902 lm	S3 21°	BB 36V Max.500mA	Z5 14* 60* 34* J6* E3* DL*
		W9 3000K CRI90/2047 lm	M3 31°		
		X9 4000K CRI90/2191 lm	F1 40°		
AT15 - Quadratisch / Mit rahmen Quadrato / Con cornice ⌀ 65 0-70 mm  					
AT16 - Rund / zurückversetzt / mit Rahmen Rotondo / retrocesso / con cornice ⌀ 85 0-25 mm  					

	IP		u. max		Code
			u. min	220-240V 110-127V	
AT11					
AT12					
AT13					
AT14		ON-OFF	1	1	71-E068-00-00
AT15	IP68	DALI	1	1	71-E085-00-00
AT16		0-10V	1	1	71-E085-00-00
AT17					
AT18		ON-OFF	1	2	71-3542-00-00
	IP20	DALI	1	2	71-4706-00-00
		0-10V	1	2	71-4706-00-00
	Optional IP66 IK09 box (300x200x105mm)				71-E100-00-00

① P. 946

nicht inklusive / Non incluso	
IP68-Stecker mit 6 Eingängen / Connettore IP68 a 6 ingressi	71-9199-05-05
IP67-Stecker mit 3 Eingängen / Connettore IP67 a 3 ingressi	71-9262-05-05
IP68- Antikondensationsstecker mit 2 Eingängen Connettore IP68 con valvola anticondensa a 2 ingressi	71-E112-00-00
5 Lichtfilter für gestreute Lichtkegel / 5 filtri per l'emissione di luce diffusa	71-E260-00-00
5 Lichtfilter für elliptische Lichtkegel / 5 filtri per emettere luce ellittica	71-E261-00-00
5 Lichtfilter für quadratische Lichtkegel / 5 filtri per l'emissione di luce quadrata	71-E262-00-00
5 Wabenraster / 5 pannelli a nido d'ape	71-E263-00-00
Unterputzdose / Scatola da incasso (AT14, AT15)	71-E355-00-00
Unterputzdose / Scatola da incasso (AT16)	71-E356-00-00

*Fragen Sie unser Verkaufsteam nach den Lieferbedingungen.

Consultare i termini e le condizioni di consegna al nostro team commerciale.



Dako

BODY MAT	DIF MAT		50000h	3
AL	GLA		L80 B20	MacAdam



Starr und schwenkbar Fisso e regolabile

Diese Downlight-Serie zum Deckeneinbau ist die Lösung für Räume, in denen eine starke Leistung und ein klares und äußerst kompaktes Design erforderlich sind. Dank des ausgezeichneten UGR-Werts von unter 13, ist sie hervorragend für die Installation in öffentlichen oder privaten Bereichen geeignet, für die eine genaue und robuste Beleuchtung mit sehr gutem Sehkomfort nötig ist.

Questa collezione di downlight per installazione ad incasso nei soffitti, offre una soluzione per spazi che richiedono alte prestazioni insieme ad un design pulito ed ultracompatto. Con un ottimo indice UGR, inferiore a 13, è ideale per l'installazione in spazi pubblici o privati che richiedono un apparecchio preciso, resistente e con un grande comfort visivo.

Dako gibt es als starre und schwenkbare Variante mit einem Schwenkbereich von $\pm 20^\circ$. Beide haben ähnliche Eigenschaften in Bezug auf Leistung, Abstrahlwinkel und Installation. Con caratteristiche simili in termini di prestazioni, angoli di apertura ed installazione, Dako viene fornito con un'opzione fissa e regolabile, con una rotazione di $\pm 20^\circ$.

Abstrahlwinkel Angoli di apertura



Inklusive zwei Reflektoren mit mittlerem Abstrahlwinkel von 23° bis 40° und einem matten Diffusor zur Lichtstreuung für Anwendungen in der Allgemeinbeleuchtung.

Include due riflettori con angoli di apertura medi, da -23° a 40° - ed un filtro diffusore per creare un'illuminazione generale anziché d'accento.



Hoher visueller Komfort Alto comfort visivo

Zu den hervorstechenden Merkmalen dieser Serie gehört ihr hoher Sehkomfort dank der auf einer tieferen Ebene angebrachten Reflektoren. Dadurch wird die Blendung auf ein Minimum reduziert.

Una delle caratteristiche di questa gamma è l'elevato comfort visivo che offre, poiché i riflettori sono posti ad un livello inferiore, riducendo così l'abbagliamento, al minimo.

Metallgehäuse für bessere Wärmeableitung
Corpo in metallo per una maggiore dissipazione del calore

Zurückversetzte LED zur Vermeidung von Blendung
LED sommerso per evitare l'abbagliamento



Wasserdichtes Gehäuse
Chiusura stagna

Installationsoptionen Opzioni di installazione

Dako kann problemlos in Betondecken eingebaut werden, da es für diesen Zweck eine spezielle Einbaudose bietet.
Dako può essere installato senza difficoltà, nei soffitti in cemento, poiché offre una scatola da incasso appositamente progettata per questo fine.

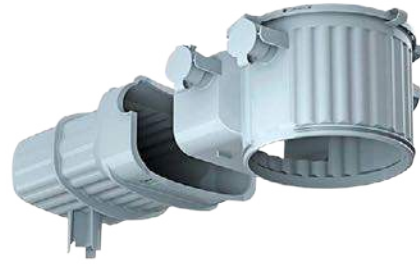

Externer Treiber Driver remoto

Mit externem IP67-Treiber.
Include Driver remoto IP67.



DAKO

Dako Fixed

IP	IK	UGR			BREEAM
66	06	<13		ON-OFF	

05 ●

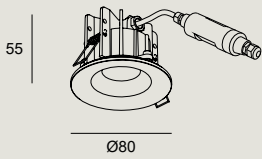

LED						
K	CRI	W LED	WT	Total	Optics	Code
3000	80	6.4	7.5	502	Medium 40°	15-E035 - 05 - CL
		100-240V 50-60Hz				

inklusive / Incluso

IP67 Driver & Connector
IP67 Driver & Connector
28,8° und 40° Reflektoren
Riflettori 28,8° e 40°
Diffusor-Filter
Filtro diffusore

nicht inklusive / Non incluso

Unterputzdose
Scatola da incasso **71-E035-00-00**

IP	IK	UGR			BREEAM
66	07	<16		ON-OFF	

05 ●

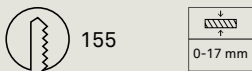
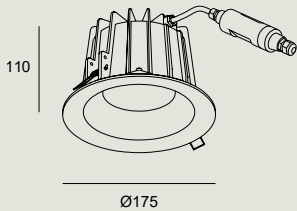

LED						
K	CRI	W LED	W Total	Real Lm	Optics	Code
3000	80	18	20	1821	Medium 31°	15-E036 - 05 - CL
		100-240V 50-60Hz				

inklusive / Incluso

IP67 Driver & Connector
IP67 Driver & Connector
23,6° und 31° Reflektoren
Riflettori 23,6° e 31°
Diffusor-Filter
Filtro diffusore

nicht inklusive / Non incluso

Unterputzdose
Scatola da incasso **71-E036-00-00**

DAKO

Dako Adjustable

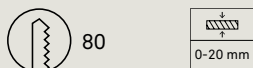
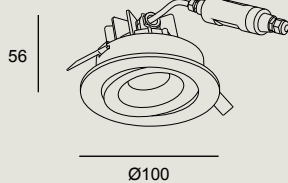

IP 66	IK 06	UGR <13	±20°	BREEM	ON-OFF	±20°
----------	----------	------------	------	-------	--------	------

05 ●

LED						
K	CRI	W LED	W Total	Real Lm	Optics	Code
3000	80	6.4	7.5	502	Medium 40°	15-E104 - 05 - CL
100-240V		50-60Hz				

inklusive / Inclusoo

IP67 Driver & Connector
IP67 Driver & Connector

28,8° und 40° Reflektoren
Riflettori 28,8° e 40°

Diffusor-Filter
Filtro diffusore

nicht inklusive / Non incluso

Unterputzdose
Scatola da incasso

71-E104-00-00

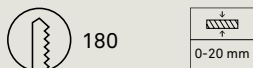
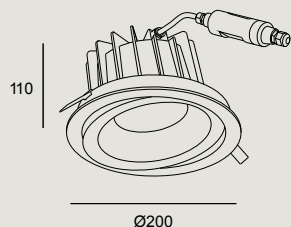

IP 66	IK 07	UGR <16	±20°	BREEM	ON-OFF	±20°
----------	----------	------------	------	-------	--------	------

05 ●

LED						
K	CRI	W LED	W Total	Real Lm	Optics	Code
3000	80	18	20	1821	Medium 31°	15-E105 - 05 - CL
100-240V		50-60Hz				

inklusive / Inclusoo

IP67 Driver & Connector
IP67 Driver & Connector

23,6° und 31° Reflektoren
Riflettori 23,6° e 31°

Diffusor-Filter
Filtro diffusore

nicht inklusive / Non incluso

Unterputzdose
Scatola da incasso

71-E105-00-00

Gea Compact

BODY MAT	DIF MAT
AISI316	GLA



	IP 66	IK 10	50000h L80 B20	3 MacAdam	UGR <19	 ±15°		SEA SIDE SUITABLE
	BREEAM							

CA

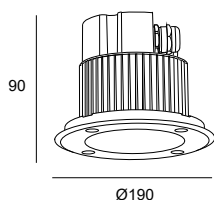

LED						
K	CRI	W LED	W Total	Real Lm	Optics	Code
3000	80	18	22	1820	Medium 40°	15-9948 - CA - CL
4000	80	18	22	1915	Medium 40°	15-9948 - CA - CM
		100-240V 50-60Hz				



Gea Technopolymer

BODY MAT	DIF MAT
AISI316	GLA

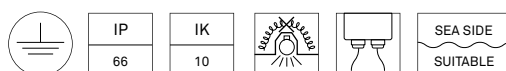

CA

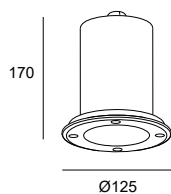

GU10/G5.3	
W	Code
max. 50	15-9708 - CA - 37

inklusive / Incluso
2 Lampenfassungen GU5.3 + GU10 2 portalampade GU5.3 + GU10



Wandeinbauleuchten

Incassi a parete

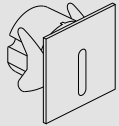

Bat
613

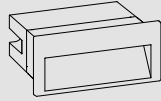

Tiny
618



Pixel
620

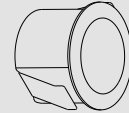

Rim
623

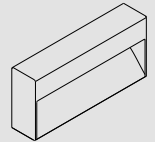

Arc
627



Micas
631

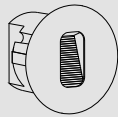

Gea
635



Bat

BODY MAT	DIF MAT		50000h	3
AL	GLA		L80 B20	MacAdam

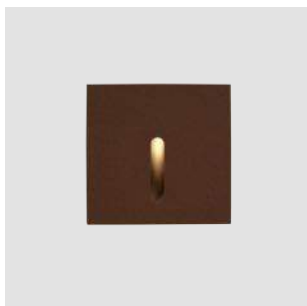

Video ansehen
Guarda il video

Verschiedene Ausführungen Molteplici finiture

Verschiedene Effekte für verschiedene Anforderungen Diversi effetti per tutte le installazioni

Bat ist eine Beschilderungslösung für den Wandeinbau mit einer Vielzahl von Lichteffekten. Dank dem eleganten und minimalistischen Design ohne sichtbare Schrauben liegt das Hauptaugenmerk auf dem Licht.

Bat è una collezione di segnaletica a parete che offre un'ampia varietà di effetti di luce. Presenta un design elegante e minimal, senza viti a vista, che lascia spazio alla vera protagonista: la luce.

Sie ist erhältlich in einer Größe mit 6 cm Durchmesser und vier verschiedenen Effektformaten; quadratisch und rund, beide mit einem engen und einem breiten Lichtstrahl. Die Kollektion bietet drei Farbtemperaturen (2700 K, 3000 K und 4000K) und drei verschiedene Oberflächen (anthrazitgrau, weiß und braun) um den Anforderungen eines jeden Projekts gerecht zu werden. È disponibile nella misura di 6 cm di diametro e 4 formati con diversi effetti, quadrato e rotondo, entrambi con un fascio di luce stretto ed ampio. La collezione prevede 3 temperature di colore, 2700K, 3000K e 4000K e 3 diverse finiture, grigio antracite, bianco e marrone per adattarsi alle esigenze di qualsiasi progetto.

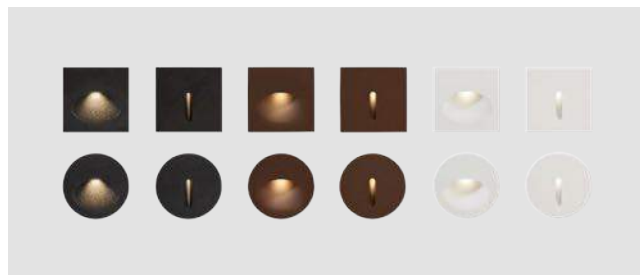

Mit Bat lassen sich unterschiedliche Effekte in den verschiedenen Versionen erzeugen. Der enge Lichtstrahl in der runden oder quadratischen Ausführung eignet sich perfekt für die Beleuchtung von Treppenhäusern. Der breite Lichtstrahl hingegen, den es auch in runder oder quadratischer Ausführung gibt, erfüllt die Beleuchtungsanforderungen in Durchgangsbereichen.

Bat ti permette di creare diversi effetti nelle sue diverse versioni. Il fascio stretto, in opzione tondo o quadrato, è perfetto per illuminare le scale. D'altra parte, l'ampio fascio luminoso, anche nella sua versione tonda o quadrata, risponde alle esigenze di illuminazione delle zone di transito.



Hoher visueller Komfort Alto comfort visivo

Das Kopfteil von Bat weist ein besonderes Design auf, bei dem die LED versenkt ist und die Leuchte somit einen hohen visuellen Komfort bietet.

La testa di Bat ha un design speciale in modo che il LED sia incavato, ottenendo così, un elevato comfort visivo dell'apparecchio.



Einbauleuchte der Spitzenqualität Incasso di massima qualità

Bat wurde konzipiert, um die höchste auf dem Markt erhältliche Einbauqualität zu erreichen. Das Gehäuse besteht aus maschinell gefertigtem Aluminium und es verfügt über einen Glasdiffusor, welches die Lebensdauer des Produkts maximieren und seine Installation in feuchten Umgebungen oder sogar direkt am Meer ermöglichen. Zudem sind Flügel für die Installation in Rigipsplatten und spezielle Abdichtungsstopfen inbegriffen, um die Dichtigkeit und Zuverlässigkeit der Leuchte zu garantieren.

Bat è progettato per diventare l'incasso di miglior qualità del mercato. Il suo corpo è realizzato in alluminio lavorato e con un diffusore in vetro per massimizzare la vita utile del prodotto, permettendo la sua installazione in ambienti umidi o anche sul lungomare. Inoltre, comprende alette per l'installazione in cartongesso, insieme a premistoppa speciale antiapertura che garantiscono la tenuta e l'affidabilità dell'apparecchio.



BAT

IP	IK		SEA SIDE
66	10	1 m	SUITABLE

14 J6 Z5

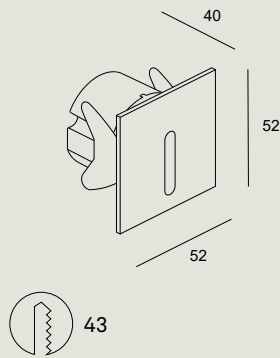

LED						
K	CRI	W LED	W Total	Real Lm	Code	
2700	80	2.2	2.2	11	14 05-E017 - J6 - CK Z5	
3000	80	2.2	2.2	11	14 05-E017 - J6 - CL Z5	
4000	80	2.2	2.2	11	14 05-E017 - J6 - CM Z5	

3V Max. 700mA

IP	IK		SEA SIDE
66	10	1 m	SUITABLE

14 J6 Z5

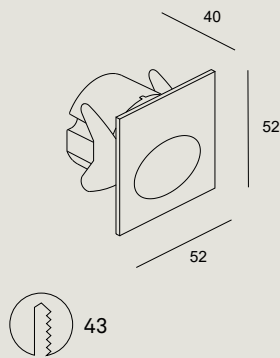

LED						
K	CRI	W LED	W Total	Real Lm	Code	
2700	80	2.2	2.2	45	14 05-E016 - J6 - CK Z5	
3000	80	2.2	2.2	45	14 05-E016 - J6 - CL Z5	
4000	80	2.2	2.2	45	14 05-E016 - J6 - CM Z5	

3V Max. 700mA



BAT

IP	IK		SEA SIDE
66	10	1 m	SUITABLE

14 J6 Z5

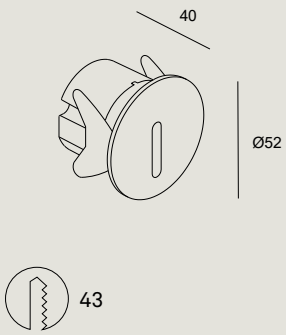

LED						
K	CRI	W LED	W Total	Real Lm	Code	
2700	80	2.2	2.2	11	14 05-E015 - J6 - Z5	CK
3000	80	2.2	2.2	11	14 05-E015 - J6 - Z5	CL
4000	80	2.2	2.2	11	14 05-E015 - J6 - Z5	CM

3V Max. 700mA

BAT

IP	IK		SEA SIDE
66	10	1 m	SUITABLE

14 J6 Z5

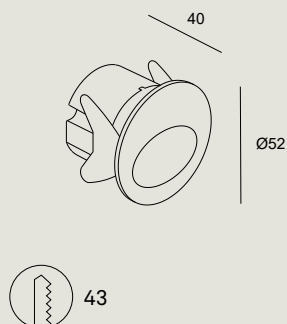

LED						
K	CRI	W LED	W Total	Real Lm	Code	
2700	80	2.2	2.2	45	14 05-E014 - J6 - CK Z5	
3000	80	2.2	2.2	45	14 05-E014 - J6 - CL Z5	
4000	80	2.2	2.2	45	14 05-E014 - J6 - CM Z5	

3V Max. 700mA

05-E014 05-E015 05-E016 05-E017	IP		u. min	u. max		Code
				220-240V	110-127V	
		ON-OFF	2	4	4	71-E014-00-00
	IP68	DALI	1	14	7	71-E080-00-00
		0-10V	1	8	7	71-E081-00-00
		ON-OFF	1	7	5	71-3308-00-00
	IP20	DALI	1	8	6	71-6192-00-00
		0-10V	1	8	6	71-7710-00-00
	Optional IP66 IK09 box (300x200x105mm)					71-E100-00-00

① P. 946

mitgeliefertes allgemeines Zub. Klemmen für Wandmontage
Access. comuni inclusi Morsetti per fissaggio a parete

nicht mitgeliefertes allgemeines Zub.
Access. comuni non inclusi

IP68-Stecker mit 6 Eingängen Connettore IP68 a 6 ingressi	71-9199-05-05
IP67-Stecker mit 3 Eingängen Connettore IP67 a 3 ingressi	71-9262-05-05
Unterputzdose Scatola da incasso	71-E065-60-00
IP68- Antikondensationsstecker mit 2 Eingängen Connettore IP68 con valvola anticondensa a 2 ingressi	71-E112-00-00

Tiny

BODY MAT	DIF MAT		50000h	3
AL	GLA		L80 B20	MacAdam

Tiny ist eine Kollektion von Wandeinbauleuchten zur Beleuchtung von Treppen, bei denen die Leuchten zwischen den Stufen angebracht werden, sowie für enge Durchgangsbereiche. Das kompakte Design und die gut durchdachte Positionierung der LEDs sorgt außerdem für einen hervorragenden visuellen Komfort und dafür, dass selbst beim Hinaufsteigen der Treppe niemand geblendet wird.

Tiny è una collezione di applique da incasso pensate per illuminare le scale, posizionando gli apparecchi tra i gradini, incluso in passaggi stretti. Il prodotto è dotato di un design compatto con un ottimo comfort visivo grazie alla disposizione dei led, studiato per evitare qualsiasi abbagliamento, incluso salendo le scale, con la luce frontale.



Hervorragender Sehkomfort Eccellente comfort visivo

Durch das besondere Design des Kopfteils kann die LED versenkt werden, was einen ausgezeichneten visuellen Komfort bei jeder Art von Installation garantiert.

Il particolare design della sua testa permette di incassare il led, garantendo un ottimo comfort visivo in ogni tipo di installazione.

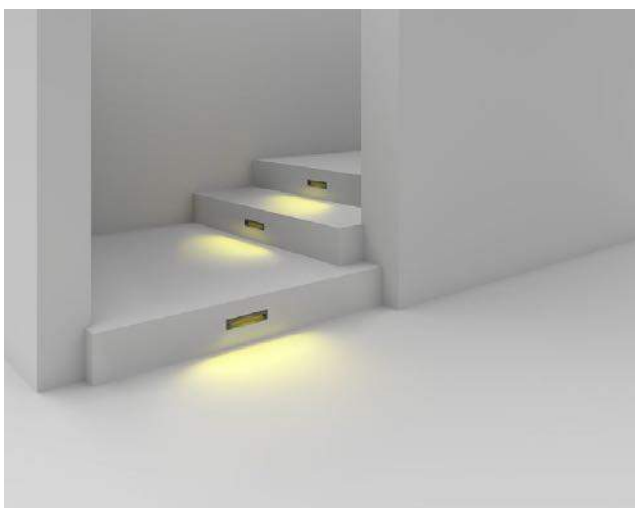

Maximale Lebensdauer Massima durabilità

Ein Gehäuse aus Aluminium mit speziellem, vor dem Lackieren aufgetragenen Rostschutz, um die Lebensdauer des Produkts zu maximieren und die Installation in nassen Umgebungen oder sogar direkt am Meer zu ermöglichen. Zudem reduziert das System die Innentemperatur und wirkt wärmeabführend. Dies sorgt für eine maximale Lebensdauer der LED und des Treibers.

Dispone di un corpo in alluminio con speciale protezione contro la ruggine, prima della verniciatura, per massimizzare la vita utile del prodotto e che può essere installato in ambienti umidi o anche sul lungomare. Inoltre, il suo sistema di evacuazione dell'aria calda, riduce la temperatura interna dell'apparecchio e consente di prolungare, al massimo, la durata del LED e del driver.

TINY

IP	IK		SEA SIDE	
65	10	2 m	SUITABLE	ON-OFF

Z5 ●

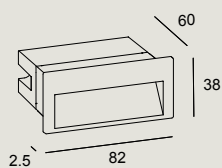

LED					
K	CRI	W LED	W Total	Real Lm	Code
3000	80	1.9	2.9	18	05-E146 - Z5 - CL
220-240V		50-60Hz			

IP	IK		SEA SIDE	
65	10	2 m	SUITABLE	ON-OFF

Z5 ●

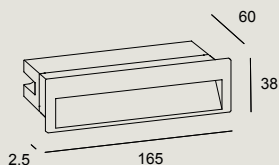

LED					
K	CRI	W LED	W Total	Real Lm	Code
3000	80	5.9	7.8	74	05-E147 - Z5 - CL
220-240V		50-60Hz			



OUTDOOR WANDINBAULEUCHTEN / INCASSI A PARETE

mitgeliefertes allgemeines Zub. Unterputzdose
Access. comuni inclusi Cassetta da incasso

nicht mitgeliefertes allgemeines Zub. <i>Access. comuni non inclusi</i>	IP68-Stecker mit 6 Eingängen Connettore IP68 a 6 ingressi	71-9199-05-05
	IP67-Stecker mit 3 Eingängen Connettore IP67 a 3 ingressi	71-9262-05-05
	IP68- Antikondensationsstecker mit 2 Eingängen Connettore IP68 con valvola anticondensa a 2 ingressi	71-E112-00-00
	IP68- Antikondensationsstecker mit 4 Eingängen Connettore IP68 con valvola anticondensa a 4 ingressi	71-E122-00-00

Pixel

BODY MAT	DIF MAT		50000h	3
AL, AISI316	GLA		L80 B20	MacAdam



Video ansehen
Guarda il video

Eine Markierungskollektion mit starker Leistung, die einen bestimmten Bereich oder Durchgang durch verschiedene Lichteffekte vom Boden oder von der Wand abgrenzt. Pixel hat ein klares Design und kleine Abmessungen und ist in drei Formaten mit unterschiedlichen Lichtöffnungswinkeln erhältlich.

Collezione di segnaletica ad alte prestazioni destinata a delimitare una zona ed aree di passaggio dal pavimento o dalla parete, attraverso diversi effetti di luce. Pixel si presenta con un design pulito e con dimensioni ridotte, essendo disponibile in 3 formati con diverse aperture di luce.



Visueller Komfort Comfort visivo

Dank der mit Fenstern versehenen Struktur mit der Leuchte und der versenkten Anordnung der LED blendet das Licht nicht, was zu einem höheren visuellen Komfort führt.

Grazie alla struttura con finestre di cui è dotato il corpo illuminante e alla disposizione ad incasso dei LED, la luce non abbaglia e permette generare un maggior comfort visivo.



Umfangreiches Sortiment Vasta gamma

Pixel ist in einer Größe und drei Formaten erhältlich. Mit einem, zwei und vier Fenstern oder Lichtstrahlöffnungen und in zwei Farbtemperaturen: 3000 K und 4000 K.

Pixel è disponibile in 1 misura e in 3 formati. Con 1, 2 e con 4 finestre o aperture del fascio di luce e in 2 temperature di colore: 3000K e 4000K.



PIXEL

IP 65/67	IK 10				
-------------	----------	--	--	--	--

CA

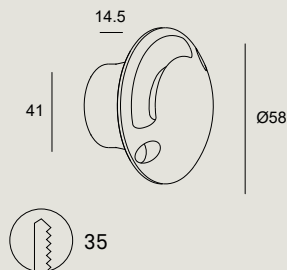

LED				
K	CRI	W LED	Real Lm	Code
3000	80	3.4	10	55-E001 - CA - CL
4000	80	3.4	10	55-E001 - CA - CM

24VDC

IP 65/67	IK 10				
-------------	----------	--	--	--	--

CA

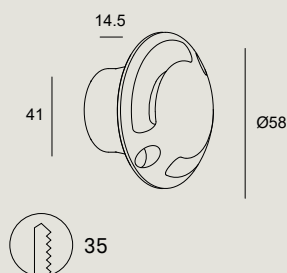

LED				
K	CRI	W LED	Real Lm	Code
3000	80	3.4	21	55-E002 - CA - CL
4000	80	3.4	22	55-E002 - CA - CM

24VDC

IP 65/67	IK 10				
-------------	----------	--	--	--	--

CA

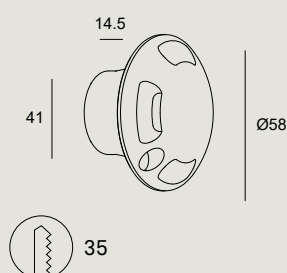

LED				
K	CRI	W LED	Real Lm	Code
3000	80	3.4	15	55-E003 - CA - CL
4000	80	3.4	16	55-E003 - CA - CM

24VDC

55-E001 55-E002 55-E003	IP		u. min	u. max	Code	
	IP68	ON-OFF		1	4	71-E101-05-05
				1	15	71-E159-00-00
	IP67	DALI		1	15	71-E098-00-00
		0-10V		1	10	71-E094-00-00
Optional IP66 IK09 box (300x200x105mm)					71-E100-00-00	

P. 946

mitgeliefertes allgemeines Zub. Access. comuni inclusi	Unterputzdose Cassetta da incasso	
nicht mitgeliefertes allgemeines Zub. Access. comuni non inclusi	IP68-Stecker mit 6 Eingängen Connettore IP68 a 6 ingressi	71-9199-05-05
	IP67-Stecker mit 3 Eingängen Connettore IP67 a 3 ingressi	71-9262-05-05
	IP68- Antikondensationsstecker mit 2 Eingängen Connettore IP68 con valvola anticondensa a 2 ingressi	71-E112-00-00
	IP68- Antikondensationsstecker mit 4 Eingängen Connettore IP68 con valvola anticondensa a 4 ingressi	71-E122-00-00
Smart Compatible-Zub. Access. Smart Compatibile	Driver Casambi PWM 1ch IP66	71-A242-00-00



Rim

BODY MAT
AISI316

DIF MAT
GLA



50000h
L80 B20



Video ansehen
Guarda il video

Rim ist Beleuchtung auf höchstem Niveau für zuverlässige Orientierungsbeleuchtung in höchster Qualität. Der beidseitig geschliffene Diffusor aus gehärtetem Glas sorgt für beispiellose Lichtqualität und eine perfekte Homogenität. Die Niederspannungsversorgung maximiert zudem die Sicherheit der Leuchte und ermöglicht eine steuerbare Installation in der Nähe von Brunnen und Schwimmbecken.

Rim è il massimo esponente dell'illuminazione di segnaletica, affidabile e di alta qualità. Il suo diffusore in vetro temperato con processo di sbiancamento su entrambi i lati conferisce un'ottima qualità ed omogeneità. Inoltre, l'alimentatore a bassa tensione massimizza la sicurezza dell'installazione e ne consente il montaggio in aree vicino a fontane e piscine, nonché la regolazione.

Weniger ist mehr
Meno è di più

Als Neuheit ist Rim in einer kleineren Größe mit 20 mm Durchmesser erhältlich, die sich vollständig in die Umgebung einfügen lässt und gleichzeitig alle Vorzüge der Kollektion bewahrt.

Come novità, Rim si presenta con un nuovo formato più piccolo di 20 mm di diametro che permette una totale integrazione nell'ambiente, preservando tutte le caratteristiche della collezione.



**Farbtemperatur warmweiss,
neutralweiss und blaues Licht**
**Temperatura calda,
neutra e luce blu**

Erhältlich in zwei Größen und in zwei Farbtemperaturen (3000 K und 4000 K). Die Ausführung mit 46 mm Durchmesser wird auch in einer Variante mit blauen LED angeboten, welche dank des guten Kontrasts in der Dunkelheit häufig zur Markierungsbeleuchtung eingesetzt werden.

Viene offerto in 2 misure con 2 temperature di colore (3000K e 4000K). La versione da 46 mm di diametro ha anche l'opzione di un LED blu, frequentemente utilizzato nella segnaletica, essendo il colore che ha il maggior contrasto al buio.



RIM

IP 65/67	IK 10	3 MacAdam		 1 m		SEA SIDE SUITABLE	
-------------	----------	--------------	--	---------	--	----------------------	--

CA

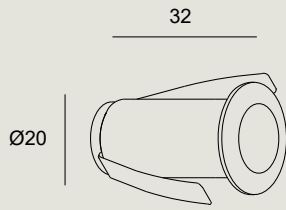

LED					
K	CRI	W LED	W Total	Real Lm	Code
3000	80	0.5	0.5	3	55-E006 - CA - CL
4000	80	0.5	0.5	4	55-E006 - CA - CM

24VDC



55-E006	IP		u. min	u. max	Code
	IP68	ON-OFF	1	39	71-E101-05-05
		ON-OFF	1	45	71-E158-00-00
	IP67	DALI	1	30	71-E098-00-00
		0-10V	1	30	71-E094-00-00
	Optional IP66 IK09 box (300x200x105mm)				71-E100-00-00

P. 946

inklusive / Incluso
Klemmen für Wandmontage Morsetti per fissaggio a parete
Unterputzdose Cassetta da incasso

RIM

IP 65/67	IK 10	3 MacAdam	2000 kg	1 m		
-------------	----------	--------------	---------	-----	--	--

CA



LED					
K	CRI	W LED	W Total	Real Lm	Code
Blue		1	1.5	3	55-E151 - CA - 11
3000	80	1	1.5	17	55-E151 - CA - CL
4000	80	1	1.5	17	55-E151 - CA - CM

24VDC

55-E151	IP		u. min	u. max	Code
	IP68	ON-OFF	1	13	71-E101-05-05
		ON-OFF	1	14	71-E158-00-00
	IP67	DALI	1	30	71-E098-00-00
		0-10V	1	23	71-E096-00-00
Optional IP66 IK09 box (300x200x105mm)					71-E100-00-00

P. 946

inklusive / Incluso
Klemmen für Wandmontage Morsetti per fissaggio a parete
Unterputzdose Cassetta da incasso

nicht mitgeliefertes allgemeines Zub. Access. comuni non inclusi	IP68-Stecker mit 6 Eingängen Connettore IP68 a 6 ingressi	71-9199-05-05
	IP67-Stecker mit 3 Eingängen Connettore IP67 a 3 ingressi	71-9262-05-05
	IP68- Antikondensationsstecker mit 2 Eingängen Connettore IP68 con valvola anticondensa a 2 ingressi	71-E112-00-00
	IP68- Antikondensationsstecker mit 4 Eingängen Connettore IP68 con valvola anticondensa a 4 ingressi	71-E122-00-00
Smart Compatible-Zub. Access. Smart Compatibile	Driver Casambi PWM 1ch IP66	71-A242-00-00



Arc

BODY MAT	DIF MAT		50000h	3
AL,CON	GLA		L80 B20	MacAdam



Höchster Komfort Massimo comfort

Die Wandleuchte Arc vertieft das Angebot an Outdoor-Produkten aus Zement. Auf der Suche nach Produkten, die sich bestmöglich in die Architektur integrieren, wurde diese Wandleuchte entwickelt, welche in Wände oder Oberflächen eingelassen werden kann und dank des ausgeklügelten Designs und einer rechteckigen, sehr flachen Struktur praktisch mit der Umgebung verschmilzt. Arc wurde entwickelt, um Gänge zu beleuchten und das Hauptaugenmerk auf Licht und Raum zu lenken.

L'appliche da parete Arc consolida la proposta di un prodotto da esterno, in cemento. Con l'intenzione di materializzare prodotti che siano completamente integrati nell'architettura, questa applique può essere installata ad incasso, a parete o in superficie. Con questo prodotto si mantiene un'ottima integrazione nell'ambiente con un design lavorato ed una struttura rettangolare, molto poco profonda. Arc è progettato per illuminare i passaggi, dando tutto il risalto alla luce ed allo spazio.

Der optische Block von Arc ist nach unten geneigt, um einen Durchgangsbereich blendfrei auszuleuchten, und zwar genau an der Stelle, an der der maximale Lichtstrom dorthin gelenkt wird, wo er benötigt wird, um den visuellen Komfort zu maximieren.

Il blocco ottico di Arc è orientato con un angolo verso il basso, per illuminare un passaggio senza abbagliare, posizionato esattamente in modo che il massimo flusso luminoso sia diretto dove serve, massimizzando il comfort visivo.



Maximale Lebensdauer Massima durabilità

Aufgrund seiner Ausführung in Beton kann es in feuchten Umgebungen oder sogar am Meer installiert werden.

Grazie alla sua composizione in cemento, può essere installato in ambienti umidi o anche sul lungomare.

Maximale Integration Massima integrazione

Als Neuheit ist Arc mit einer neuen Einbaueinheit ausgestattet, die in die Wand eingebaut werden und dem Raum eine besondere Eleganz verleihen kann.

Come novità, Arc si presenta con una nuova scatola da incasso che si installa a parete, conferendo un'eleganza totale allo spazio.



Einfache und schnelle Installation Installazione facile e rapida

Das LED-Modul lässt sich schnell installieren und im Falle eines Ausfalls leicht austauschen. Doppelter Kabelausgang, um die Installation in Reihe zu vereinfachen.

Installazione rapida del modulo LED, facilmente sostituibile, in caso di guasto. Include una doppia uscita del cavo per facilitare l'installazione a catena.

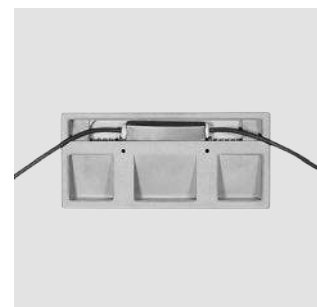

ARC

IP	IK		SEA SIDE SUITABLE	
66	10			ON-OFF

DC 

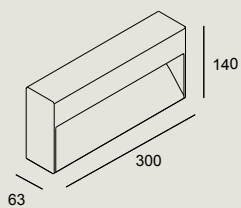

LED					
K	CRI	W LED	W Total	Real Lm	Code
3000	80	9	9	404	05-E090 - DC - CL 05-E091
4000	80	9	9	404	05-E090 - DC - CM

	ON-OFF	Voltage	Frequency
05-E090	ON-OFF	230V	50-60Hz
05-E091	ON-OFF	120V	60Hz

nicht inklusive / Non incluso

Unterputzdose
Scatola da incasso

71-E090-Z5-00



Micenas

BODY MAT	DIF MAT		50000h	3
AL	GLA		L80 B20	MacAdam



Kollektion leistungsstarker Leuchten zum Wandeinbau für die Beleuchtung großer Bereiche von der Wand aus. Diese professionelle Lösung besteht durch ein zeitloses Design, das sich in die Architektur jedes Projekts einfügen und integrieren lässt. Zur Verwendung in Räumen mit widrigen Umgebungsbedingungen wie Feuchtigkeit und Staub geeignet.

Collezione di applique da incasso ad alta potenza per illuminare grandi aree, dalla parete. Questa soluzione professionale ha un design duraturo nel tempo, consentendo di adattarsi e integrarsi nell'architettura di qualsiasi progetto. Può essere installato in ambienti esposti a condizioni avverse, dovute all'umidità e alla polvere.

Hochleistungs-Frontlicht Luce frontale ad alta efficienza

Die Micenas Symmetrical-Kollektion erfüllt den BREEAM-Standard, da sie über ein direktes Frontlicht verfügt, um die Lichtintensität und Effizienz zu maximieren.

La collezione Micenas Symmetrical è conforme allo standard BREEAM in quanto dispone di una luce frontale diretta, per massimizzare il flusso luminoso e l'efficienza.

Verschiedene Oberflächen Diverse rifiniture

Auf Wunsch kann Micenas Symmetrical in den von LEDS C4 angebotenen Standardfarben lackiert werden.

Micenas Symmetrical può essere verniciato, su richiesta, con i colori standard offerti da LEDS C4.



Verschiedene Lichteffekte Diversi effetti di luce

Micenas bietet verschiedene Ausführungen mit unterschiedlichen Lichteffekten für jeden Bedarf.

Micenas propone diversi modelli con vari effetti di luce per soddisfare ogni esigenza.

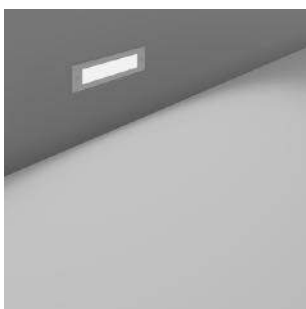

Micenas Symmetrical

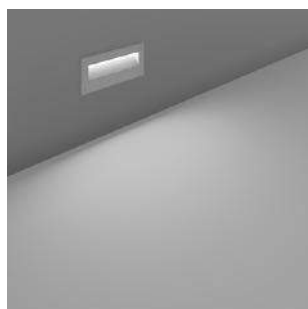

Micenas Asymmetrical

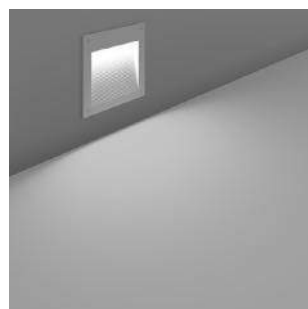

Micenas Asymmetrical



Micenas Effect

Smart

Micenas Asymmetrical ist in Ausführungen mit integrierter Casambi Bluetooth Mesh-Technologie erhältlich, mit der verschiedene Konnektivitätsfunktionen mit herkömmlichen Elektroinstallationen kombiniert werden können.

Micenas Asymmetrical dispone di versioni con tecnologia Casambi Bluetooth Mesh integrata, che consente di unire diverse funzionalità di connessione rispetto all'impianto elettrico tradizionale.

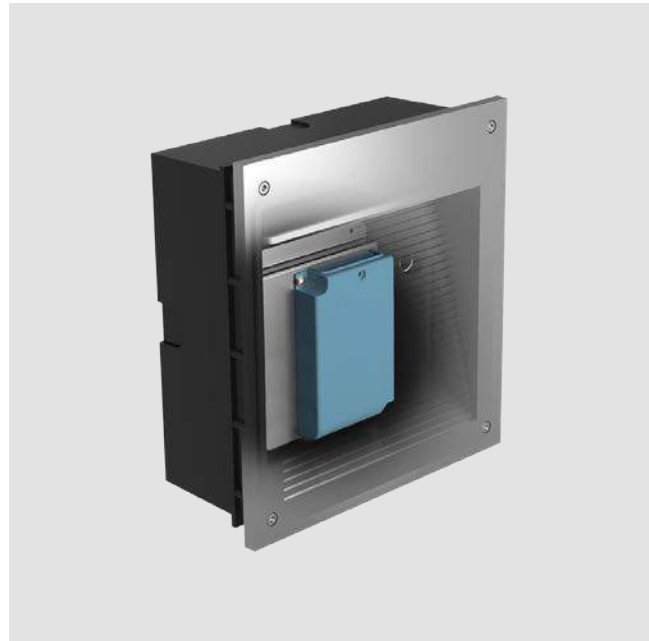

Smart-Funktionen: Kalenderprogrammierung Funzionalità Smart: Programmazione in base al calendario

Unter den möglichen Funktionen der Ausführung Micenas Asymmetrical Smart ist die programmierbare Anwesenheitssimulation nach Zeitplan mithilfe der integrierten Casambi-Bluetooth-Mesh-Technologie.

Una delle possibili funzionalità della versione Smart di Micenas Asymmetrical consiste nella programmazione della simulazione di presenza, secondo il calendario e grazie alla tecnologia Casambi Bluetooth Mesh, integrata.



MICENAS

Micenas Symmetrical

IP 66	IK 04		SEA SIDE SUITABLE	ON-OFF	BREEAM
----------	----------	--	----------------------	--------	--------

14* 34 60* DL* J6* Z5

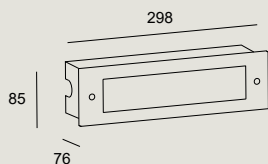

LED										
K	CRI	W LED	W Total	Real Lm		Code				
3000	80	8.7	10.4	731	05-E051	14				
						34				
						60				
						DL	-		CL	
						J6				
4000	80	8.7	10.4	779	05-E051	14				
						34				
						60				
						DL	-		CM	
						J6				
						100-277V 50-60Hz				

inklusive / Incluso

Unterputzdose
Cassetta da incasso

MICENAS

Micenas Asymmetrical

IP 66	IK 10		SEA SIDE SUITABLE	
----------	----------	--	----------------------	--

34 Z5

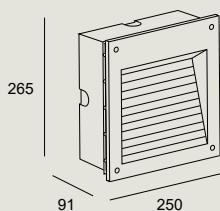

LED										
K	CRI	W LED	W Total	Real Lm		Code				
3000	80	20	22.5	504	05-9885	34				
						05-E024 -	Z5	-	CL	
						05-E049				
4000	80	20	22.5	530	05-9885	34				
						05-E024 -	Z5	-	CM	
						05-E049				
						05-9885 ON-OFF 100-240V 50-60Hz 05-E024 Casambi 100-240V 50-60Hz 05-E049 1-10V/PUSH/DALI 100-240V 50-60Hz				

inklusive / Incluso

Unterputzdose
Cassetta da incasso



*Fragen Sie unser Verkaufsteam nach den Lieferbedingungen.

Consultare i termini e le condizioni di consegna al nostro team commerciale.

MICENAS



Micenas Asymmetrical

IP	IK		SEA SIDE SUITABLE	
66	10			

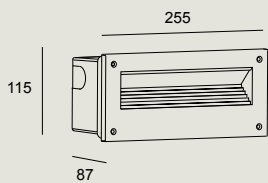
34  Z5 



LED						
K	CRI	W LED	W Total	Real Lm	Code	
3000	80	5.5	6.6	128	05-9832 05-E025 - 34 - CL 05-E050	Z5
4000	80	5.5	6.6	136	05-9832 05-E025 - 34 - CM 05-E050	Z5

	05-9832	ON-OFF	100-240V	50-60Hz
	05-E025	Casambi	220-240V	50-60Hz
	05-E050	DALI-2	100-240V	50-60Hz

inklusive / Incluso

Unterputzdose
Cassetta da incasso

MICENAS

Micenas Effect

IP	IK		SEA SIDE SUITABLE
66	10	ON-OFF	

34 

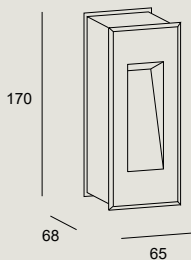

LED						
K	CRI	W LED	W Total	Real Lm	Code	
3000	80	2.2	3.7	70	05-9758 - 34 - 37	

	100-240V	50-60Hz
---	----------	---------

inklusive / Incluso

Unterputzdose
Cassetta da incasso

Gea Effect

BODY MAT	DIF MAT	50000h	3
AISI316	GLA	L80 B20	MacAdam



	IP	IK	SEA SIDE
	65	10	SUITABLE

CA

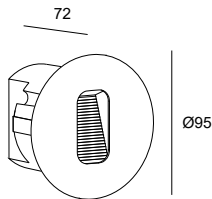

LED					
K	CRI	W LED	W Total	Real Lm	Code
3000	80	2.2	3.7	68	05-9757 - CA - CL
100-240V		50-60Hz			

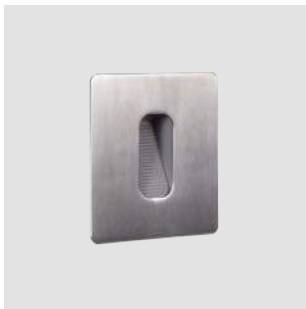

	IP	IK	SEA SIDE
	65	10	SUITABLE

CA

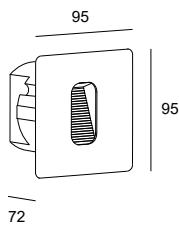

LED					
K	CRI	W LED	W Total	Real Lm	Code
3000	80	2.2	3.7	68	05-E031 - CA - CL
100-240V		50-60Hz			

mitgeliefert **allgemeines Zub.** Unterputzdose
 Access. comuni inclusi Cassetta da incasso



OUTDOOR WANDEINBAULEUCHTEN / INCASSI A PARETE



Bodeneinbauleuchten

Incassi a pavimento



Max

639

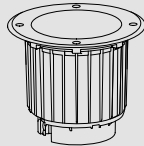

Gea

645

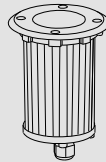

Kay

663



Ios

667



Pixel

671

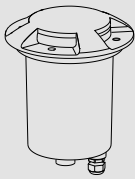

Xena

674

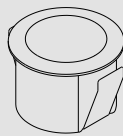

Rim

677



MAX

DIF MAT		50000h
GLA		L80 B20



Video ansehen
Guarda il video

Maximale Leistung Massime prestazioni

Umfangreiches Zubehör Ampia gamma di accessori

Die Bodeneinbau der Familie Max ist in drei Formaten erhältlich: quadratisch, rund und tief randlos. Auf diese Weise können Lösungen für jeden Beleuchtungsbedarf in Bereichen wie Terrassen oder Eingängen von Büros, Hotels oder Wohnräumen angeboten werden. Auch hier kommen drei größere und leistungsstärkere Modelle hinzu, die alle mit 3 Farbtemperaturen (2700K, 3000K, 4000K) und 4 verschiedenen Abstrahlwinkeln (8, 6°, 17°, 27°, 50°) erhältlich sind, um allen Projekten gerecht zu werden. Als Ergänzung sind eine Wabenplatte und ein Filter zur Lichtstreuung für ovales Licht und quadratisches Licht erhältlich.

Il faretto da incasso a pavimento della famiglia Max è disponibile in 3 formati: quadrato, rotondo e rotondo trimless per rispondere alle esigenze di illuminazione in spazi come terrazze o portici di uffici, hotel o residenze. Ci sono 3 modelli più grandi e più potenti, tutti disponibili in 3 temperature (2700K, 3000K, 4000K) e in 4 diverse angolazioni (8,6°, 17°, 27°, 50°) per adattarsi a tutti i progetti. Inoltre, può essere completato con un pannello a nido d'ape e con filtri a luce diffusa, luce ovale o luce quadrata.

Max verfügt über eine kompakte Struktur, die beständig gegenüber den Witterungsbedingungen am Meer ist und aus austauschbaren LED-Modulen im ökologischen Design, einem Glasdiffusor mit IK10-Widerstand und hermetischer Abdichtung nach IP66/IP67 sowie einer Auswahl verschiedener Streulicht-, ovaler und quadratischer Filter besteht.

Max è dotato di una struttura compatta e resistente all'atmosfera marina, essendo composto da moduli LED eco-progettati per essere sostituibili, un diffusore in vetro, con resistenza IK10 e chiusura ermetica, per garantire un IP66/IP67; si permette, inoltre, la scelta tra diversi filtri di luce diffusa, ovale e quadrata.

Die Kollektion beinhaltet eine große Auswahl an Zubehör wie einen elliptischen Diffusor, einen quadratischen Diffusor, ein Wabenraster und eine Weichzeichnerlinse.

La collezione dispone di un'ampia gamma di accessori quali diffusore ellittico, diffusore quadrato, pannello a nido d'ape e diffusore dell'alone.



② **Struktur**
Struttura

Uplight Trimless
Uplight Round
Uplight Square

③ **Moduli**
Modulo

Umweltfreundlich
austauschbare LED-Module
Moduli LED eco-progettati
per essere sostituiti

④ **Zubehör im
Lieferumfang enthalten**
Accessori inclusi

Öffnungswinkel:
8,6° - 17° - 27° - 50°
Angoli di apertura:
8,6° - 17° - 27° - 50°

⑥ **Abdichtung**
Chiusura

Cierre hermético para
garantizar IP65
Fecho hermético para
garantir IP65

Sonderzubehör
Accessori opzionali

① **Einbaudose**
Scatola da incasso

- ⑤ **Elliptischer Diffusor**
Diffusore ellittico
Quadratischer Diffusor
Diffusore quadrato
Wabendiffusor
Diffusore pannello a
nido d'ape
Lichthof-Diffusor
Diffusore dell'alone

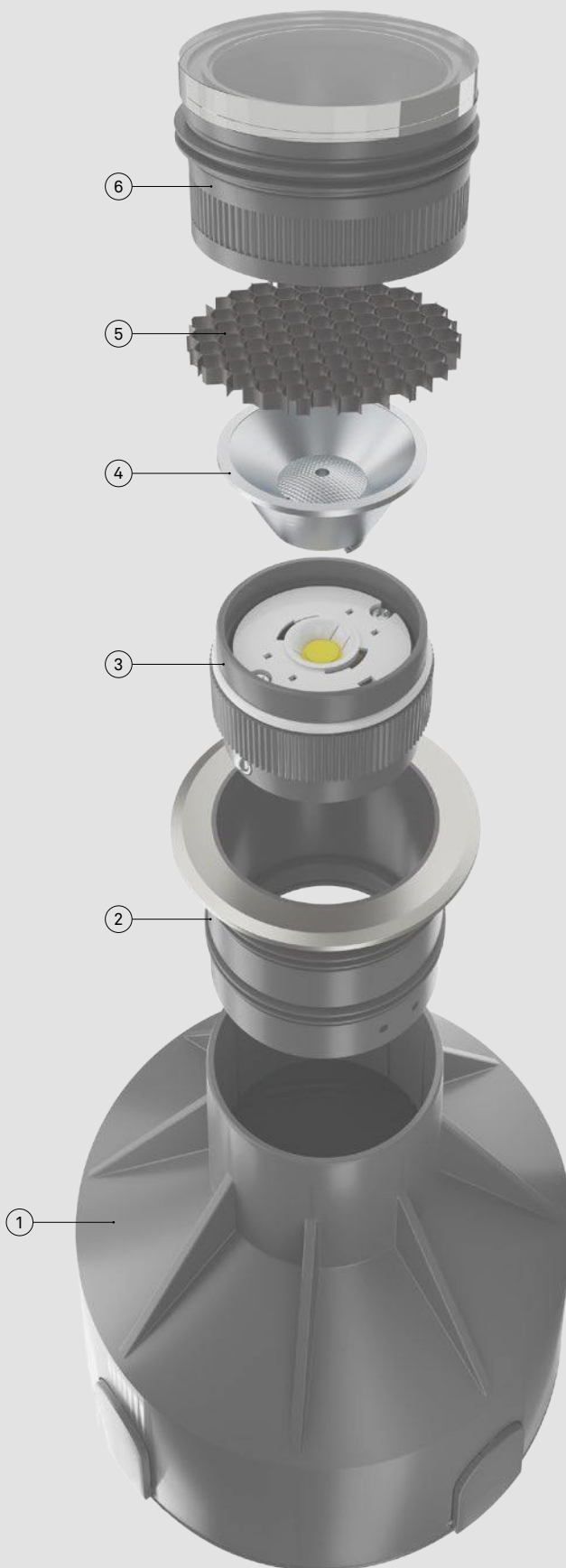













MAX

Max Uplight



Codebeispiel / Esempio di codice: AI11-P4V9S1BBCA

Model	W	K/ Cri/ Real lm	Optics	Source	Finishes
AI11 - Quadratisch / Mit rahmen Quadrato / Con cornice ⌀ 60  	P4 4W	V9 2700K CRI90/286 lm	S1 9°	BB  12V Max. 350mA	CA  Only for AI11/AI12 Z5  Only for AI13
		W9 3000K CRI90/286 lm			
		X9 4000K CRI90/286 lm			
AI12 - Rund / Mit rahmen Rotondo / Con cornice ⌀ 60  	P7 6.5W	V9 2700K CRI90/519 lm	S2 17°	BB  18V Max. 350mA	
		W9 3000K CRI90/519 lm	M2 27°		
		X9 4000K CRI90/519 lm	F1 50°		
AI13 - Rund / Mit rahmen Rotondo / Con cornice  					

	u. max							
	IP		u. min	P4 (8,6°)		P7 (17°/ 27°/ 50°)		Code
AI11				220-240V	110-127V	220-240V	110-127V	
AI12		ON-OFF	1	4	3	2	2	71-E079-00-00
AI13								
AI14	IP68	DALI	1	4	4	2	2	71-E083-00-00
AI15								
AI16		0-10V	1	4	4	2	2	71-E083-00-00
AI17		ON-OFF	1	6	6	4	4	71-3542-00-00
AI18	IP20	DALI	1	6	6	4	4	71-4706-00-00
		0-10V	1	6	6	4	4	71-4706-00-00
	Optional IP66 IK09 box (300x200x105mm)							71-E100-00-00

ⓘ P. 946

inklusive / Incluso
Unterputzdose / Casseta da incasso (AI13)
Saugnapf zum Herausnehmen von LED-Modulen / Ventosa di estrazione moduli LED





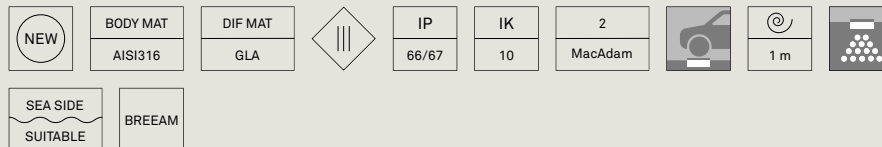

nicht inklusive / Non incluso	
IP68-Stecker mit 6 Eingängen / Connettore IP68 a 6 ingressi	71-9199-05-05
IP67-Stecker mit 3 Eingängen / Connettore IP67 a 3 ingressi	71-9262-05-05
IP68- Antikondensationsstecker mit 2 Eingängen Connettore IP68 con valvola anticondensa a 2 ingressi	71-E112-00-00
5 Wabenraster / 5 pannelli a nido d'ape	71-E131-00-00
5 Lichtfilter für gestreute Lichtkegel / 5 filtri per l'emissione di luce diffusa	71-E133-00-00
5 Lichtfilter für quadratische Lichtkegel / 5 filtri per l'emissione di luce quadrata	71-E135-00-00
Unterputzdose / Scatola da incasso (AI11, AI12)	71-E139-00-00
5 Lichtfilter für elliptische Lichtkegel / 5 filtri per emettere luce ellittica	71-E141-00-00

MAX

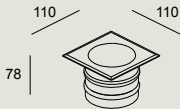
Max Uplight

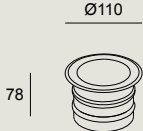

Codebeispiel / Esempio di codice: AT11-18V9S3BBCA

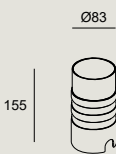
Model	W	K/ Cri/ Real lm	Optics	Source	Finishes
AT11 - Quadratisch / Mit rahmen Quadrato / Con cornice  	18 17,3W	V9 2700K CRI90/1902 lm	S3 21°	BB  36V Max.500mA	CA 
		W9 3000K CRI90/2047 lm	M3 31°		
		X9 4000K CRI90/2191 lm	F1 40°		
AT12 - Rund / Mit rahmen Rotondo / Con cornice  					
AT13 - Rund / Ohne rahmen Rotondo / Senza cornice  					

	IP		u.		Code	
			min	max		
AT11 AT12 AT13 AT14				220-240V	110-127V	
AT15 AT16 AT17 AT18	IP68	ON-OFF	1	1	1	71-E068-00-00
		DALI	1	1	1	71-E085-00-00
		0-10V	1	1	1	71-E085-00-00
	IP20	ON-OFF	1	2	2	71-3542-00-00
		DALI	1	2	2	71-4706-00-00
		0-10V	1	2	2	71-4706-00-00
	Optional IP66 IK09 box (300x200x105mm)					71-E100-00-00

① P. 946

inklusive / Incluso

Unterputzdose / Cassetta da incasso (AT13)
 Saugnapf zum Herausnehmen von LED-Modulen / Ventosa di estrazione moduli LED

nicht inklusive / Non incluso

IP68-Stecker mit 6 Eingängen / Connettore IP68 a 6 ingressi	71-9199-05-05
IP67-Stecker mit 3 Eingängen / Connettore IP67 a 3 ingressi	71-9262-05-05
IP68- Antikondensationsstecker mit 2 Eingängen Connettore IP68 con valvola anticondensa a 2 ingressi	71-E112-00-00
5 Lichtfilter für gestreute Lichtkegel / 5 filtri per l'emissione di luce diffusa	71-E260-00-00
5 Lichtfilter für elliptische Lichtkegel / 5 filtri per emettere luce ellittica	71-E261-00-00
5 Lichtfilter für quadratische Lichtkegel / 5 filtri per l'emissione di luce quadrata	71-E262-00-00
5 Wabenraster / 5 pannelli a nido d'ape	71-E263-00-00
Unterputzdose / Scatola da incasso (AT11, AT12)	71-E264-00-00



Gea

DIF MAT
GLA



Gea ist im Programm von von LEDS C4 die vielseitigste Kollektion an Bodeneinbauleuchten und bietet eine Vielzahl von Möglichkeiten, um den Anforderungen von Projekten aller Art im Außenbereich gerecht zu werden. Die robuste, strapazierfähige Konstruktion besteht aus ausgewählten Werkstoffen, die mit speziellen Verfahren behandelt werden, um dem Produkt eine möglichst lange Lebensdauer zu verleihen. Ideal für der Installation in feuchter Umgebung oder sogar direkt am Meer. Die stabile Struktur ermöglicht die Installation auch in Bereichen mit Fahrzeugverkehr.

Gea è la collezione di faretti da incasso al suolo più versatile di LEDS C4, dal momento che offre una grande varietà di opzioni per soddisfare tutte le necessità di qualsiasi tipo di progetti per esterni. Dal design resistente e molto duratura, questa collezione è realizzata con materiali e speciali processi protettivi che puntano a massimizzare la vita utile del prodotto. Perfetta per installazioni in ambienti umidi o anche sul lungomare. La struttura resistente consente l'installazione anche in zone con traffico di veicoli.



Gea Pro

P. 648

Ausgezeichnete Lichtpräzision.
Eccellente precisione luminosa.



Ø 85 mm



Ø 125 mm



Ø 185 mm



Ø 300 mm

2 W - 40 W



Spot - Medium - Flood



Gea Cob

P. 649

Umfangreiches Sortiment und vielfältiges
Zubehör.
Ampia gamma e vari accessori.



Ø 125 mm



Ø 185 mm



Ø 223 mm



Ø 300 mm

34,7 W



Spot - Flood



Gea Wall Washer

P. 650

Perfekte Fassadenbeleuchtung.
Bagno perfetto di facciate.



Ø 185 mm



Ø 233 mm

17 W - 24 W



Asymmetrical



Gea Compact

P. 651

Geringe Einbautiefe einschließlich Technik.
Poca profondità con dispositivo incluso.



∅ 120 mm



∅ 130 mm



∅ 180 mm

6 W - 18 W



Spot - Medium



Gea Signaling

P. 651

Kleine Uplights für die Signalisierung.
Piccoli uplight di segnalazione.



∅ 45 mm



∅ 60 mm

0,5 W - 1 W



Gea Technopolymer

P. 651

Hohe Lebensdauer in Feuchtbereichen
und rauen Umgebungen.
Alta durabilità in zone umide e ambienti
difficili.



∅ 120 mm



∅ 130 mm



∅ 185 mm

11,9 W - Max. 50 W



Spot - Flood



GEA PRO



Dies ist die fachtechnischste und professionellste Baureihe der Kollektion einem klaren Zweck: in den Boden eingebaute vertikale Architekturbeleuchtung. Gea Pro erfüllt die strengsten Anforderungen in Sachen Leistung und Haltbarkeit, ohne auf funktionelles und modernes Design zu verzichten.

È la gamma più tecnica e professionale della collezione, con una chiara funzionalità: l'illuminazione architettonica verticale integrata nel pavimento. Gea Pro soddisfa i più alti requisiti di prestazioni e durata, senza perdere di vista il suo design funzionale e moderno.

Winke- und Temperaturoptionen Opzioni di angoli di apertura e temperatura

Die Kollektion ist mit drei Öffnungswinkeln (spot, medium und flood) und zwei Farbtemperaturen (3000 K und 4000 K) erhältlich.

Viene fornito con 3 angoli di apertura (spot, medium e flood) e con 2 temperature di colore (3000K e 4000K).

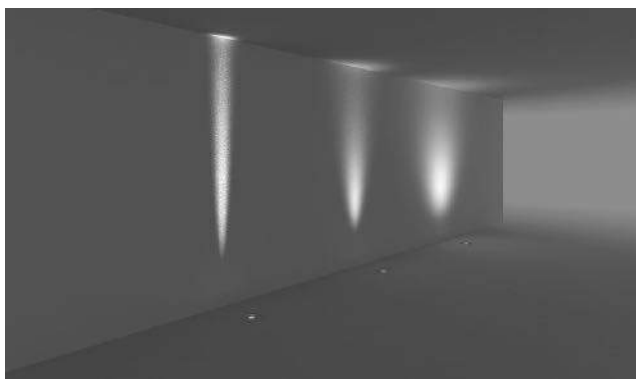

Öffnungswinkel 10° - 29° - 61°

Angoli di apertura 10° - 29° - 61°

Maximale Lebensdauer Massima durabilità

Mit Gehäuse aus verarbeitetem Aluminium mit speziellem, vor dem Lackieren aufgetragenen Rostschutz, sowie einem Rahmen aus AISI316-Edelstahl, um die Lebensdauer des Produkts zu maximieren und die Installation in nassen Umgebungen oder sogar direkt am Meer zu ermöglichen. Die stabile Struktur ermöglicht die Installation auch in Bereichen mit Fahrzeugverkehr. Umfasst zudem ein Gehäuse mit doppeltem Schutz, das die Elektronik der Leuchte isoliert und einen größeren Schutz bietet, um Schäden an der LED oder dem Treiber zu verhindern und so deren Lebensdauer zu verlängern.

Dotato di un corpo in alluminio trattato con speciale protezione contro la ruggine, prima della verniciatura, e di una cornice in acciaio inox AISI316, per massimizzare la vita utile del prodotto, può essere installato anche in ambienti umidi o sul lungomare. La struttura resistente consente l'installazione anche in zone con traffico di veicoli. Comprende inoltre un doppio alloggiamento di protezione per isolare l'elettronica dell'apparecchio e offrire una maggiore protezione, che evita il danneggiamento del LED e del driver e ne prolunga la vita utile.

GEA COB



Höchster visueller Komfort Massimo comfort visivo

Die Baureihe der im Boden eingebauten Uplights Gea Cob bietet vielfältige Anwendungsmöglichkeiten im Außenbereich. Die Kollektion bietet vielfältige Konfigurationsmöglichkeiten, eine außerordentliche Qualität des LED-Moduls und die Möglichkeit, den Lichtkegel einzustellen, das Innenteil auszurichten und an die Bedürfnisse hinsichtlich Beleuchtung und der Umgebung maximal anzupassen.

Gea Cob è una collezione di uplight da incasso a pavimento, pensata per coprire le diverse esigenze di ogni tipologia di spazio esterno. Altamente configurabile, offre una qualità eccezionale del modulo LED, la possibilità di regolare il fascio di luce, di orientare il corpo interno, oltre ad adeguarsi alle massime esigenze di illuminazione dell'ambiente.

Alle Ausführungen sind serienmäßig mit zwei optionalen Blendschutzvorrichtungen ausgestattet, sodass auch bei der Installation der beste Licht- und Sehkomfort gewählt werden kann.

Tutte le versioni includono 2 antiabbagliamento di serie opzionali per poter scegliere la migliore opzione di illuminazione e comfort visivo, anche durante l'installazione.

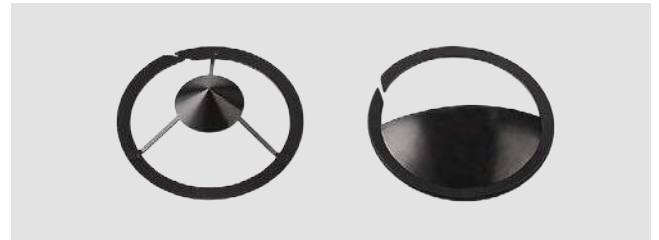

Verfügbare Farbtemperaturen Temperatura opzionale

Erhältlich in drei Farbtemperaturen (2700 K, 3000 K und 4000 K).
Disponibile in 3 temperature di colore (2700K, 3000K y 4000K).

Maximale Lebensdauer Massima durabilità



Das Gehäuse bietet einen doppelten Schutz, da die Elektronik der Leuchte getrennt isoliert ist. Dies gewährleistet einen größeren Schutz und verhindert Schäden an der LED oder dem Treiber und hilft so, deren Lebensdauer zu verlängern. Die stabile Struktur ermöglicht die Installation auch in Bereichen mit Fahrzeugverkehr. Umfasst zudem ein längeres Kabel mit doppeltem Ausgang für eine einfache Installation in Reihe und an schwer zugänglichen Stellen.

Incorpora una doppia carcassa di protezione per isolare l'elettronica dell'apparecchio ed offrire una maggiore protezione, prevenendo il danneggiamento del LED o del driver e prolungandone la vita utile. La sua robusta struttura permette la sua installazione anche in zone con traffico stradale. Include, inoltre, un cavo più lungo, con doppia uscita, per facilitare l'installazione a catena, in spazi di difficile accesso.

GEA WALL WASHER



Die Leuchten der Uplight-Kollektion Gea Wall Washer werden im Boden eingelassen und tauchen Fassaden in ein perfektes gleichmäßiges Licht. Diese technisch-professionelle Kollektion bietet vollkommen wasserdichte und resistente Leuchten, die zur Installation in Meeresnähe geeignet sind. Ihre Optik im Inneren ist besonders ausgerichtet und wurde so konzipiert, dass 100 % des Lichtstroms auf die zu beleuchtende senkrechte Fläche gelangt, ohne das Passanten durch Restlicht geblendet werden.

Gea Wall Washer è una collezione di uplight da incasso a pavimento pensata per ottenere un bagno perfetto ed omogeneo su qualsiasi facciata. Con un carattere tecnico e professionale, è un apparecchio totalmente impermeabile e resistente, installabile vicino al mare. Le sue ottiche interne, appositamente orientate, sono proiettate per emettere il 100% del flusso verso la superficie verticale da illuminare.

Großer Flutungsbereich Ampio effetto wallwasher

Optisches System, das konzipiert wurde, um eine größtmögliche Wandflächenflutung zu erzielen.

Sistema ottico progettato per ottenere la più ampia larghezza di wallwash possibile.

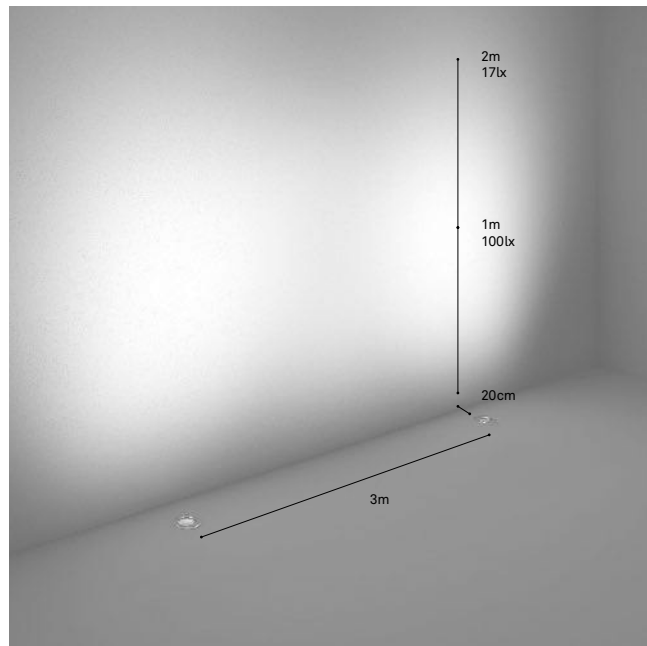
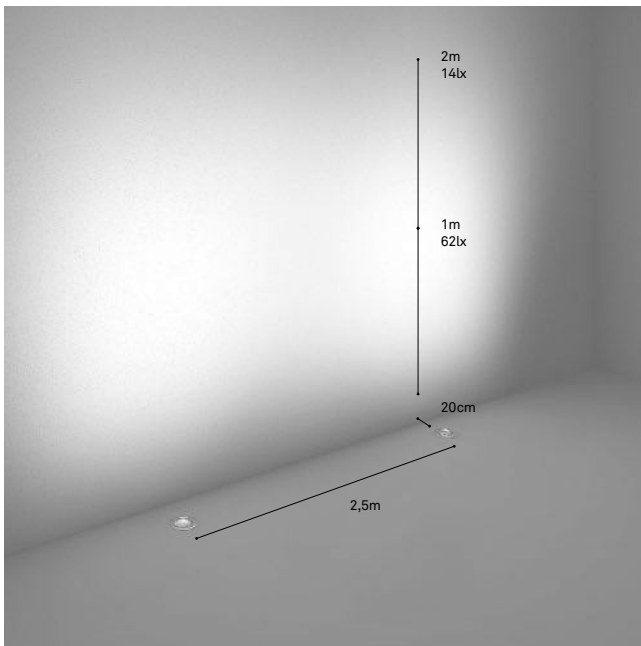

Reiheninstallation Installazione in serie

Doppelter Kabelausgang, um die Installation in Reihe zu vereinfachen.

Include una doppia uscita del cavo per semplificare l'installazione in serie.

GEA COMPACT



Gea Compact ist eine Reihe von verstellbaren Bodeneinbau-Uplights mit extrem kompaktem Design und einer Einbautiefe von nur 90 mm. Der Treiber ist serienmäßig in der Leuchte verbaut, sodass die Installation wesentlich einfacher und schneller erfolgt. Erhältlich in rund, quadratisch und in mit zwei Farbtemperaturen (3000K und 4000K, nur im runden Format).

Gea Compact è una collezione di uplight da incasso a pavimento, orientabili e dal design estremamente compatto, con soli 90 mm di profondità di installazione. Driver incorporato di serie all'interno dell'apparecchio, che offre un'installazione molto più semplice e rapida. È disponibile in versione rotonda, quadrata e in 2 temperature di colore (3000K e 4000K) solo nel formato rotondo.

GEA SIGNALING



Gea Signaling ist eine Signalleuchten-Familie, die für die Abgrenzung von Durchgangsbereichen vorgesehen ist. Die Leuchten weisen eine besonders kleine Bauform auf und bieten damit hervorragende architektonische Integrationsmöglichkeiten. Erhältlich in 12V AC/DC und 100-240V. Einschließlich wechselbarer Farbfilter.

Gea Signaling è una collezione di uplight di segnalazione, pensata per delimitare una zona di passaggio. Ha dimensioni molto ridotte per consentire la massima integrazione architettonica. Disponibile in 12V AC/DC e 100-240V. Include filtri intercambiabili colorati.

GEA TECHNOPOLYMER



Gea Technopolymer ist als Uplight-Leuchtenprogramm zum Bodeneinbau für Projekte entwickelt worden, die extrem robuste Leuchten erfordern, wie z. B. dauerfeuchte Bereiche oder besonders raue Bedingungen. Das Gehäuse aus Technopolymer ermöglicht direkten Einbau in den Boden ohne Zement. Sie ist mit zwei Leuchtmitteln (LED und GU10) erhältlich und wird in runder und quadratischer Form mit verstellbaren Ausführungen angeboten.

Gea Technopolymer è una collezione di uplight da incasso a pavimento pensata per progetti che richiedono apparecchi estremamente resistenti, come zone permanentemente umide o ambienti difficili. Il corpo realizzato in tecnopolimero gli consente di essere installato direttamente nella terra, senza bisogno di cemento. È disponibile in due sorgenti di luce (LED e GU10) e in due forme rotonda e quadrata, con versioni regolabili.

GEA PRO

BODY MAT		IP	IK	50000h	3				
AL, AISI316		65/67	10	L80 B20	MacAdam	360°	±15°		2.5 m

	SEA SIDE SUITABLE	
--	----------------------	--

CA

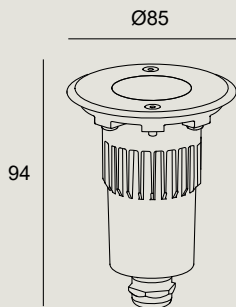

LED						
K	CRI	W LED	W Total	Real Lm	Optics	Code
3000	80	2	4.2	180	Spot 10°	55-9973
3000	80	2	4.2	162	Medium 26°	55-9974 - CA - CL
3000	80	2	4.2	167	Flood 73°	55-9975
4000	80	2	4.2	194	Spot 10°	55-9973
4000	80	2	4.2	177	Medium 26°	55-9974 - CA - CM
4000	80	2	4.2	182	Flood 73°	55-9975

100-240V 50-60Hz

inklusive / Incluso

Unterputzdose
Cassetta da incasso

BODY MAT		IP	IK	50000h	3				
AL, AISI316		65/67	10	L80 B20	MacAdam	360°	±15°		

		SEA SIDE SUITABLE		BREEAM
--	--	----------------------	--	--------

CA

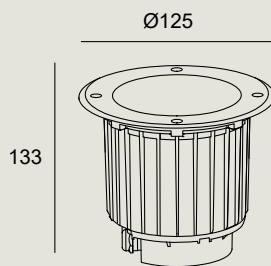

LED						
K	CRI	W LED	W Total	Real Lm	Optics	Code
3000	80	6	8	645	Spot 11°	55-9976
3000	80	6	8	621	Medium 28°	55-9977 - CA - CL
3000	80	6	8	595	Flood 72°	55-9978
4000	80	6	8	696	Spot 11°	55-9976
4000	80	6	8	677	Medium 28°	55-9977 - CA - CM
4000	80	6	8	649	Flood 72°	55-9978

100-240V 50-60Hz

inklusive / Incluso

Unterputzdose
Cassetta da incasso

GEA PRO

BODY MAT AL, AISI316		IP 65/67	IK 10	50000h L80 B20	3 MacAdam		360°		±15°		
		SEA SIDE SUITABLE		ON-OFF	BREEAM						

CA

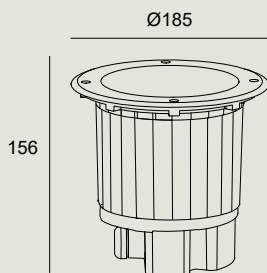

LED						
K	CRI	W LED	W Total	Real Lm	Optics	Code
3000	80	12.6	15	1169	Spot 11°	55-9968
3000	80	12.6	15	1093	Medium 26°	55-9969 - CA - CL
3000	80	12.6	15	918	Flood 46°	55-9970
4000	80	12.6	15	1228	Spot 11°	55-9968
4000	80	12.6	15	1147	Medium 26°	55-9969 - CA - CM
4000	80	12.6	15	964	Flood 46°	55-9970

100-240V 50-60Hz

inklusive / Incluso

Unterputzdose
Cassetta da incasso

BODY MAT AL, AISI316		IP 65/67	IK 10	50000h L80 B20	3 MacAdam			
		SEA SIDE SUITABLE		0-10V	BREEAM			

CA

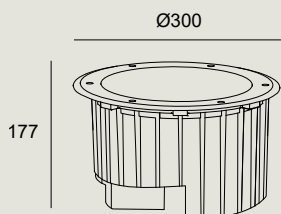

LED						
K	CRI	W LED	W Total	Real Lm	Optics	Code
3000	80	37.9	43.6	3311	Spot 10°	55-9979
3000	80	37.9	43.6	3429	Medium 26°	55-9980 - CA - CL
3000	80	37.9	43.6	3125	Flood 72°	55-9981
4000	80	37.9	43.6	3865	Spot 11°	55-9979
4000	80	37.9	43.6	4208	Medium 27°	55-9980 - CA - CM
4000	80	37.9	43.6	3642	Flood 72°	55-9981

	RGBW DMX	80	40	42	1881	Spot 13°	55-E013
	RGBW DMX	80	40	42	1838	Medium 27°	55-E014 - CA - 37
	RGBW DMX	80	40	42	1787	Flood 70°	55-E015

55-9979 55-9980 55-9981 1-10V 100-240V 50-60Hz
55-E013 55-E014 55-E015 DMX 100-240V 50-60Hz





inklusive / Incluso



Unterputzdose
Cassetta da incasso

Smart Compatible-Zub. / Access. Smart Compatible

71-A238-00-00 Converter Casambi DMX IP66

GEA COB

BODY MAT AL, AISI316		IP 65/67	IK 10	50000h L80 B20	2 MacAdam	 360°	 ±15°		
-------------------------	--	-------------	----------	-------------------	--------------	--	--	--	--



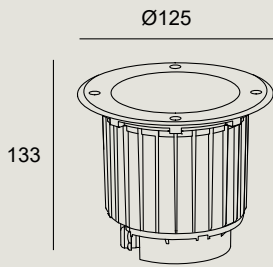

 1 m		SEA SIDE SUITABLE	 ON-OFF	BREEAM
--	---	----------------------	---	--------



CA 



LED						
K	CRI	W LED	W Total	Real Lm	Optics	Code
2700	80	9	10.5	869	Spot 17°	55-9906 - CA - CK
3000	80	9	10.5	869	Spot 17°	55-9906 - CA - CL
4000	80	9	10.5	934	Spot 17°	55-9906 - CA - CM

 100-240V 50-60Hz

BODY MAT AL, AISI316		IP 65/67	IK 10	50000h L80 B20	2 MacAdam	 360°	 ±15°		
-------------------------	--	-------------	----------	-------------------	--------------	--	--	--	--

 1 m		SEA SIDE SUITABLE	 ON-OFF	BREEAM
--	---	----------------------	---	--------

CA 

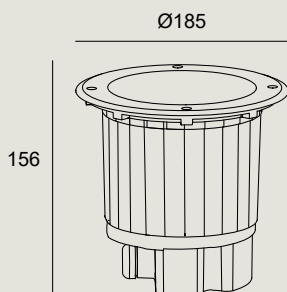

LED						
K	CRI	W LED	W Total	Real Lm	Optics	Code
2700	80	16	17.6	1630	Medium 21°	55-9907 - CA - CK
3000	80	16	17.6	1630	Medium 21°	55-9907 - CA - CL
4000	80	16	17.6	1752	Medium 21°	55-9907 - CA - CM

 100-240V 50-60Hz

GEA COB

BODY MAT AL, AISI316		IP 65/67	IK 10	50000h L80 B20	2 MacAdam				
		SEA SIDE SUITABLE		BREEAM					
1 m			ON-OFF						

CA

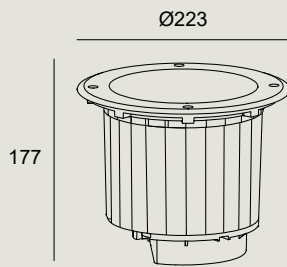

LED						
K	CRI	W LED	W Total	Real Lm	Optics	Code
2700	80	23	27	2414	Spot 18°	55-9909 - CA - CK
3000	80	23	27	2414	Spot 18°	55-9909 - CA - CL
4000	80	23	27	2586	Spot 18°	55-9909 - CA - CM
		100-240V 50-60Hz				

BODY MAT AL, AISI316		IP 65/67	IK 10	50000h L80 B20	2 MacAdam	LOW FLICKER			
		SEA SIDE SUITABLE		BREEAM					
	1 m		1-10V						

CA

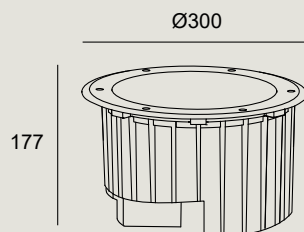

LED						
K	CRI	W LED	W Total	Real Lm	Optics	Code
2700	80	34.7	35	3681	Spot 18°	55-9972 - CA - CK
3000	80	34.7	35	3681	Spot 18°	55-9972 - CA - CL
4000	80	34.7	35	3927	Spot 18°	55-9972 - CA - CM
		100-240V 50-60Hz				

mitgeliefertes allgemeines Zub.
Access. comuni inclusi

15°- und 60°-Strahler (55-9906, 55-9907)
Riflettori 15° e 60°

25°- und 60°-Strahler (55-9909, 55-9972)
Riflettori 25° e 60°

Symmetrischer Blendschutz
Antiriflesso simmetrico

Asymmetrischer Blendschutz
Antiriflesso asimmetrico

Unterputzdose
Cassetta da incasso

GEA WALL WASHER

BODY MAT AL, AISI316		IP 65/67	IK 10	50000h L80 B20	3 MacAdam					1 m
-------------------------	--	-------------	----------	-------------------	--------------	--	--	--	--	-----

	SEA SIDE SUITABLE	
--	----------------------	--

CA

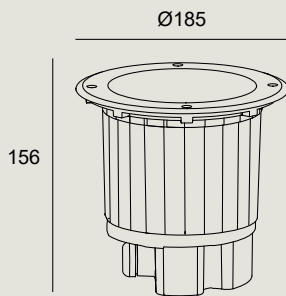

LED						
K	CRI	W LED	W Total	Real Lm	Optics	Code
3000	80	17	18.5	618	Flood 81°	55-9908 - CA - CL
4000	80	17	18.5	711	Flood 81°	55-9908 - CA - CM
		100-240V 50-60Hz				

BODY MAT AL, AISI316		IP 65/67	IK 10	50000h L80 B20	3 MacAdam					1 m
-------------------------	--	-------------	----------	-------------------	--------------	--	--	--	--	-----

	SEA SIDE SUITABLE	
--	----------------------	--

CA

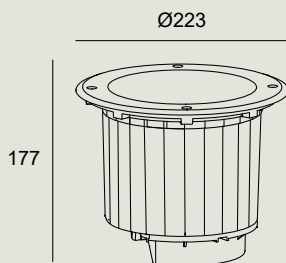

LED						
K	CRI	W LED	W Total	Real Lm	Optics	Code
3000	80	24	27.5	1008	Flood 78°	55-9910 - CA - CL
4000	80	24	27.5	1109	Flood 78°	55-9910 - CA - CM
		100-240V 50-60Hz				

mitgeliefertes allgemeines Zub.
Access. comuni inclusi

Unterputzdose
Cassetta da incasso

GEA COMPACT

Gea Compact 130mm

BODY MAT AL_AISI316		IP 65/67	IK 10	50000h L80 B20	3 MacAdam		±15°			
SEA SIDE SUITABLE		ON-OFF	BREEAM							

CA

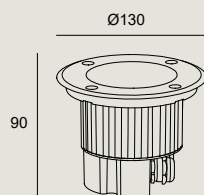

LED						
K	CRI	W LED	W Total	Real Lm	Optics	Code
3000	80	6	8.9	460	Medium 26°	55-9663 - CA - CL
4000	80	6	8.9	460	Medium 26°	55-9663 - CA - CM
		100-240V 50-60Hz				

Gea Compact 130mm RGB Easy+

BODY MAT AISI316		50000h L80 B20	IP 65/67	IK 10		±15°				SEA SIDE SUITABLE
---------------------	--	-------------------	-------------	----------	--	------	--	--	--	----------------------

CA

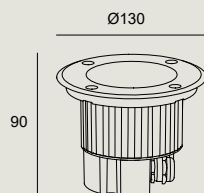

LED				
K	W LED	Real Lm	Optics	Code
RGB	6	172	Medium 24°	55-9822 - CA - 37
24VDC				

nicht inklusive / Non incluso

RGB EASY+ Master 50W RGB EASY + master 50W	71-E011-00-00
RGB EASY+ Master 150W inkl. Fernbedienung RGB EASY+ Master 150W con telecomando incluso	71-E069-00-00
RGB EASY+ Slave 150 W Schiavo RGB EASY+ di 150W	71-E070-00-00

Gea Compact 130mm RGB DMX

BODY MAT AISI316		50000h L80 B20	IP 65/67	IK 10		±15°				SEA SIDE SUITABLE	
---------------------	--	-------------------	-------------	----------	--	------	--	--	--	----------------------	--

CA

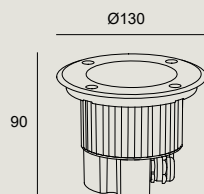

LED					
K	W LED	W Total	Real Lm	Optics	Code
RGB	6	6	172	Medium 24°	55-9823 - CA - 37
24VDC					

Smart Compatible-Zub. / Access. Smart Compatibile

71-A238-00-00 Converter Casambi DMX IP66
--

mitgeliefertes allgemeines Zub.
Access. comuni inclusi

Diffusor-Filter
Filtro diffusore

Unterputzdose
Cassetta da incasso

GEA COMPACT

Gea Compact 180mm

BODY MAT AL,AISI316		IP 65/67	IK 10	50000h L80 B20	3 MacAdam					
SEA SIDE SUITABLE		ON-OFF	BREEAM							

CA

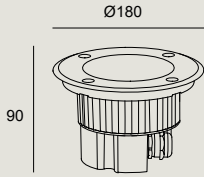

LED						
K	CRI	W LED	W Total	Real Lm	Optics	Code
3000	80	18	22	796	Spot 17°	55-9665 - CA - CL
3000	80	18	22	1101	Spot 14°	55-9667 - CA - CL
4000	80	18	22	838	Spot 17°	55-9665 - CA - 37
4000	80	18	22	1167	Spot 14°	55-9667 - CA - CM

100-240V 50-60Hz

Gea Compact 180mm RGB Easy+

BODY MAT AISI316		50000h L80 B20	IP 65/67	IK 10					SEA SIDE SUITABLE
---------------------	--	-------------------	-------------	----------	--	--	--	--	----------------------

CA

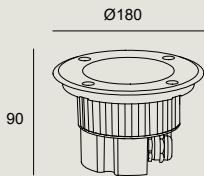

LED				
K	W LED	Real Lm	Optics	Code
RGB	17.1	424	Spot 15°	55-9824 - CA - 37

24VDC

nicht inklusive / Non incluso

RGB EASY+ Master 50W RGB EASY + master 50W	71-E011-00-00
RGB EASY+ Master 150W inkl. Fernbedienung RGB EASY+ Master 150W con telecomando incluso	71-E069-00-00
RGB EASY+ Slave 150 W Schiavo RGB EASY+ di 150W	71-E070-00-00

Gea Compact 180mm RGB DMX

BODY MAT AISI316		50000h L80 B20	IP 65/67	IK 10				SEA SIDE SUITABLE	
---------------------	--	-------------------	-------------	----------	--	--	--	----------------------	--

CA

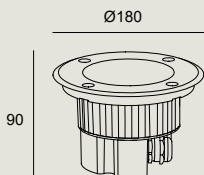

LED				
K	W LED	Real Lm	Optics	Code
RGB	17.1	424	Spot 15°	55-9825 - CA - 37







24VDC

Smart Compatible-Zub. / Access. Smart Compatible

71-A238-00-00 Converter Casambi DMX IP66

GEA COMPACT

Gea Compact 120mm

BODY MAT AISI316		50000h L80 B20	3 MacAdam	IP 65/67	IK 10	 ±15°			
SEA SIDE SUITABLE		ON-OFF							

CA 

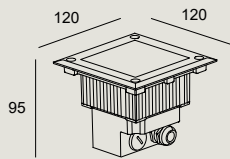

LED						
K	CRI	W LED	W Total	Real Lm	Optics	Code
3000	80	6	8.6	396	Medium 24°	55-9723 - CA - CL
 100-240V		50-60Hz				

mitgeliefertes allgemeines Zub.
Access. comuni inclusi

Diffusor-Filter
Filtro diffusore

Unterputzdose
Cassetta da incasso

GEA SIGNALING

Gea Signaling 12V AC/DC

BODY MAT		50000h	3	IP	IK				SEA SIDE
AL		L80 B20	MacAdam	65/67	05			2.5 m	SUITABLE

54

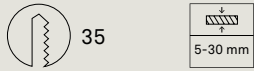
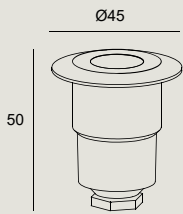

LED						
K	CRI	W LED	W Total	Real Lm	Optics	Code
4000	70	0.5	0.5	12	Flood 68°	55-9768 - 54 - T2

12V AC/DC

inklusive / Incluso

Austauschbare farbige Filter
Filtri intercambiabili colorati

Runder 3700-K-Diffusor
Diffusore circolare 3700K

Unterputzdose
Cassetta da incasso

BODY MAT		50000h	3	IP	IK				SEA SIDE
AL		L80 B20	MacAdam	65/67	05			2.5 m	SUITABLE

54

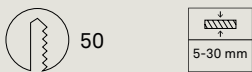
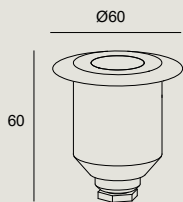

LED						
K	CRI	W LED	W Total	Real Lm	Optics	Code
4000	70	1	1	23	Flood 68°	55-9769 - 54 - T2

12V AC/DC

inklusive / Incluso

Austauschbare farbige Filter
Filtri intercambiabili colorati

Runder 3700-K-Diffusor
Diffusore circolare 3700K

Unterputzdose
Cassetta da incasso

Gea Signaling 100-240V

BODY MAT		IP	IK	50000h	3				SEA SIDE	
AL		65/67	10	L80 B20	MacAdam			2.5 m	SUITABLE	ON-OFF

54

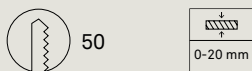
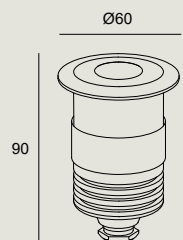

LED						
K	CRI	W LED	W Total	Real Lm	Optics	Code
3000	80	1	2.2	52	Flood 96°	55-9620 - 54 - CL
4000	80	1	2.2	52	Flood 96°	55-9620 - 54 - T2

100-240V 50-60Hz

inklusive / Incluso

Austauschbare farbige Filter
Filtri intercambiabili colorati

Unterputzdose
Cassetta da incasso

nicht mitgeliefertes
allgemeines Zub.
Access. comuni non inclusi

IP68-Stecker mit 6 Eingängen
Connettore IP68 a 6 ingressi **71-9199-05-05**

IP67-Stecker mit 3 Eingängen
Connettore IP67 a 3 ingressi **71-9262-05-05**

IP68- Antikondensationsstecker mit 2 Eingängen
Connettore IP68 con valvola anticondensa a 2 ingressi **71-E112-00-00**

IP68- Antikondensationsstecker mit 4 Eingängen
Connettore IP68 con valvola anticondensa a 4 ingressi **71-E122-00-00**

GEA TECHNOPOLYMER

BODY MAT AISI316,POLI		IP 65/67	IK 10				SEA SIDE SUITABLE
--------------------------	--	-------------	----------	--	--	--	----------------------

Gea Technopolymer GU10 Fixed

CA

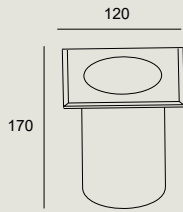

GU10				
<table border="0"> <tr> <td style="text-align: center;">W</td> <td style="text-align: right;">Code</td> </tr> <tr> <td style="text-align: center;">max. 50</td> <td style="text-align: right;">55-9281 - CA - 37</td> </tr> </table>	W	Code	max. 50	55-9281 - CA - 37
W	Code			
max. 50	55-9281 - CA - 37			

BODY MAT AISI316,POLI		IP 65/67	IK 10				SEA SIDE SUITABLE
--------------------------	--	-------------	----------	--	--	--	----------------------

CA

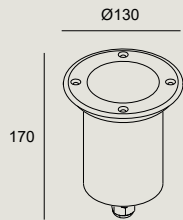

GU10				
<table border="0"> <tr> <td style="text-align: center;">W</td> <td style="text-align: right;">Code</td> </tr> <tr> <td style="text-align: center;">max. 50</td> <td style="text-align: right;">55-9280 - CA - 37</td> </tr> </table>	W	Code	max. 50	55-9280 - CA - 37
W	Code			
max. 50	55-9280 - CA - 37			

Gea Technopolymer GU10 Adjustable

BODY MAT AISI316,POLI		IP 65/67	IK 10					SEA SIDE SUITABLE
--------------------------	--	-------------	----------	--	--	--	--	----------------------

CA

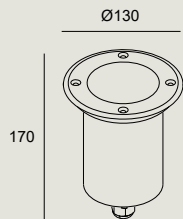

GU10				
<table border="0"> <tr> <td style="text-align: center;">W</td> <td style="text-align: right;">Code</td> </tr> <tr> <td style="text-align: center;">max. 50</td> <td style="text-align: right;">55-9380 - CA - 37</td> </tr> </table>	W	Code	max. 50	55-9380 - CA - 37
W	Code			
max. 50	55-9380 - CA - 37			

Gea Technopolymer LED Adjustable

BODY MAT AISI316,POLI		50000h L80 B20	2 MacAdam	IP 65/67	IK 10					
	SEA SIDE SUITABLE		BREEAM							
2,5 m		ON-OFF								

CA

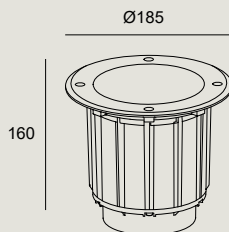

LED						
K	CRI	W LED	W Total	Real Lm	Optics	Code
3000	80	11.9	12.7	1276	Medium 21°	55-E038 - CA - CL
100-240V		50-60Hz				

inklusive / Incluso

15°- und 60°-Strahler
Riflettori 15° e 60°

Symmetrischer Blendschutz
Antiriflesso simmetrico

Asymmetrischer Blendschutz
Antiriflesso asimmetrico

mitgeliefertes allgemeines Zub.
Access. comuni inclusi

Unterputzdose
Cassetta da incasso



Kay

BODY MAT	DIF MAT		50000h	2
AL,AISI316	GLTMP		L80 B20	MacAdam



Video ansehen
Guarda il video

Kay ist eine Kollektion von Bodeneinbauleuchten mit einem klaren Zweck: die vertikale Beleuchtung von Bäumen und Büschen sowie von Außenwänden mit großem visuellem Komfort. Kay è una collezione di faretti da pavimento con una chiara funzionalità: illuminazione verticale di alberi, arbusti e pareti in qualsiasi spazio esterno con un grande comfort visivo.

Vielseitigkeit Versatilità

Erhältlich in drei Größen mit 8 cm, 12,5 cm und 18,5 cm Durchmesser, die ein zweckmäßiges und modernes Design aufweisen. È disponibile in 3 misure, 8 cm, 12,5 cm e 18,5 cm di diametro, con un design funzionale e moderno.



Höchster visueller Komfort Massimo comfort visivo

Kay verfügt über ein spezielles Blendschutz-Zubehör zur Verringerung des Restlichts und zur Maximierung des visuellen Komforts sowie über einen Diffusor mit asymmetrischem Filter, um den Lichtstrahl umzulenken und eine perfekte Wandflutung zu erreichen.

Kay include uno speciale accessorio antiabbagliamento per ridurre la luce residua e massimizzare il comfort visivo: include, inoltre, un filtro diffusore asimmetrico per deviare il fascio di luce ed ottenere un perfetto wallwasher sulla parete.



**Höchste Langlebigkeit und
Widerstandsfähigkeit**
Massima durabilità e
resistenza

Mit einem Gehäuse aus Aluminiumdruckguss und einem extra dicken Glasdiffusor. Diese hochwertigen Materialien maximieren die Lebensdauer des Produkts und ermöglichen sogar eine Installation in nassen Umgebungen oder in Umgebungen mit Meeresatmosphäre.

È dotato di un corpo in alluminio iniettato, di un anello in acciaio inox AISI 316 e di un diffusore in vetro extra spesso, per massimizzare la vita utile del prodotto e permettere la sua installazione in ambienti umidi o anche sul lungomare.



KAY

2 MacAdam	IP 65/67			 1 m	SEA SIDE SUITABLE	 ON-OFF
--------------	-------------	--	--	---------	----------------------	------------

CA

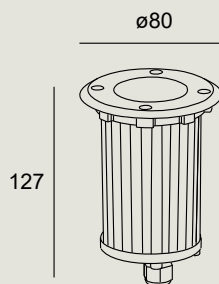

LED						
K	CRI	W LED	W Total	Real Lm	Optics	Code
3000	80	4.5	5.7	400	Medium 30°	55-E010 - CA - CL
100-240V		50-60Hz				

2 MacAdam	IP 65/67			 1 m	SEA SIDE SUITABLE	 ON-OFF
--------------	-------------	--	--	---------	----------------------	------------

CA

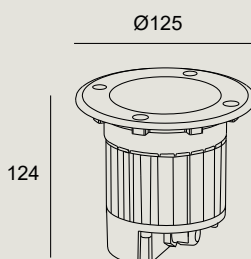

LED						
K	CRI	W LED	W Total	Real Lm	Optics	Code
3000	80	10	11.5	925	Medium 34°	55-E011 - CA - CL
100-240V		50-60Hz				

	3 MacAdam	IP 65/67			 1 m	SEA SIDE SUITABLE	 ON-OFF
--	--------------	-------------	--	--	---------	----------------------	------------

CA

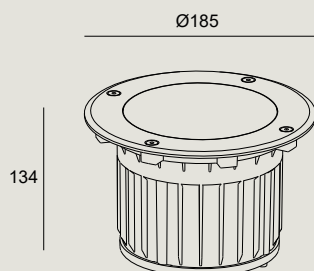

LED						
K	CRI	W LED	W Total	Real Lm	Optics	Code
3000	80	21.6	23.6	1890	Medium 35°	55-E020 - CA - CL
100-240V		50-60Hz				

mitgeliefertes allgemeines Zub.
Access. comuni inclusi

Unterputzdose
Cassetta da incasso

Blendschutz
Antiriflesso

Filter für Wall-Washer-Effekt
Filtro per effetto wall washer

**nicht mitgeliefertes
allgemeines Zub.**
Access. comuni non inclusi

IP68-Stecker mit 6 Eingängen
Connettore IP68 a 6 ingressi **71-9199-05-05**

IP67-Stecker mit 3 Eingängen
Connettore IP67 a 3 ingressi **71-9262-05-05**

IP68- Antikondensationsstecker mit 2 Eingängen
Connettore IP68 con valvola anticondensa a 2 ingressi **71-E112-00-00**

IP68- Antikondensationsstecker mit 4 Eingängen
Connettore IP68 con valvola anticondensa a 4 ingressi **71-E122-00-00**



los

BODY MAT	DIF MAT		50000h	3
AISI316	GLA		L80 B20	MacAdam

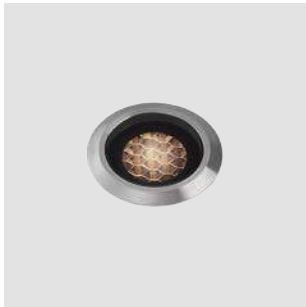

los ist eine Produktlinie ultrakompakter Einbauleuchten für Räume, die eine subtile, punktuelle Beleuchtung erfordern, bei der die Leuchte praktisch unbemerkt bleibt. Das schnörkellose Design ohne sichtbare Schrauben und die abgesenkte Anbringung der LEDs garantieren maximalen Sehkomfort. Die Niederspannungsversorgung gewährleistet ein Höchstmaß an Sicherheit und ermöglicht eine Installation in der Nähe von Brunnen und Schwimmbecken.

los è una collezione di incassi ultracompati pensata per spazi che richiedono un'illuminazione sottile e specifica, dove l'apparecchio rimane praticamente inosservato. Il suo design pulito e senza viti a vista, insieme alla disposizione incassata dei LED, garantiscono un'eccellente comfort visivo. Inoltre, l'alimentatore a bassa tensione massimizza la sicurezza dell'installazione e permette la sua installazione in zone vicino a fontane e piscine.

Symmetrisch und asymmetrisch Simmetrico ed asimmetrico

Die Bodeneinbauleuchte ist in zwei Formaten erhältlich: Symmetrisch mit einem Lichtstrahl im mittleren Winkel, der ideal zur Akzentbeleuchtung ist, und asymmetrisch mit einem auf eine Seite gerichteten Lichtstrahl, welcher sich ideal zur Beleuchtung kleiner Fassaden eignet.

L'incasso a pavimento è disponibile in 2 formati: simmetrico, con fascio luminoso a medio angolo, ideale per l'illuminazione d'accento e, asimmetrico, con fascio luminoso rivolto verso un lato, ideale per bagni di piccole facciate.

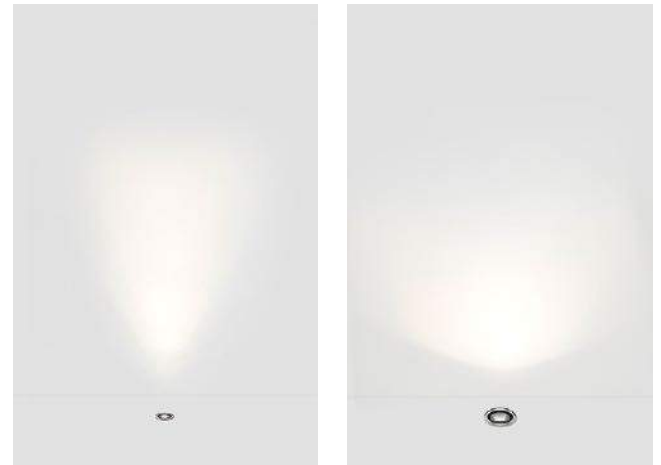

Hervorragender Sehkomfort Grande comfort visivo

Ausgezeichneter visueller Komfort dank der versenkten Anordnung der LEDs und der Verwendung von blendfreien Wabenrastern bei den symmetrischen Modellen.

Ottimo comfort visivo grazie alla disposizione incassata dei LED e all'utilizzo di pannelli a nido d'ape antiabbagliamento, nei modelli simmetrici.



Maximale Lebensdauer Massima durabilità

Mit einem Gehäuse aus hochreinem, gedrehtem Aluminium und einem Rahmen aus AISI316-Edelstahl, welche die Lebensdauer des Produkts erhöhen und eine Installation in nassen Umgebungen oder sogar direkt am Meer ermöglichen. Außerdem sind ein externes Kabel und spezielle Stopfbuchsenabdichtung inbegriffen, um die Dichtigkeit und Zuverlässigkeit der Leuchte zu garantieren.

Dotato di un corpo in alluminio tornito ad alta purezza ed una cornice in acciaio inox AISI316, per massimizzare la vita utile del prodotto e che permette la sua installazione in ambienti umidi o anche sul lungomare. Inoltre, include un cavo esterno e premistoppa speciale antiapertura, che garantiscono la tenuta e l'affidabilità dell'apparecchio.

- ① Rahmen aus AISI16-Edelstahl
Cornice in acciaio inox AISI16
- ② Versenkte Anordnung der LEDs
Disposizione incassata dei LED
- ③ Gehäuse aus hochreinem, gedrehtem Aluminium
Corpo in alluminio tornito di elevata purezza
- ④ Spezielle Stopfbuchsenabdichtung
Premistoppa speciale antiapertura

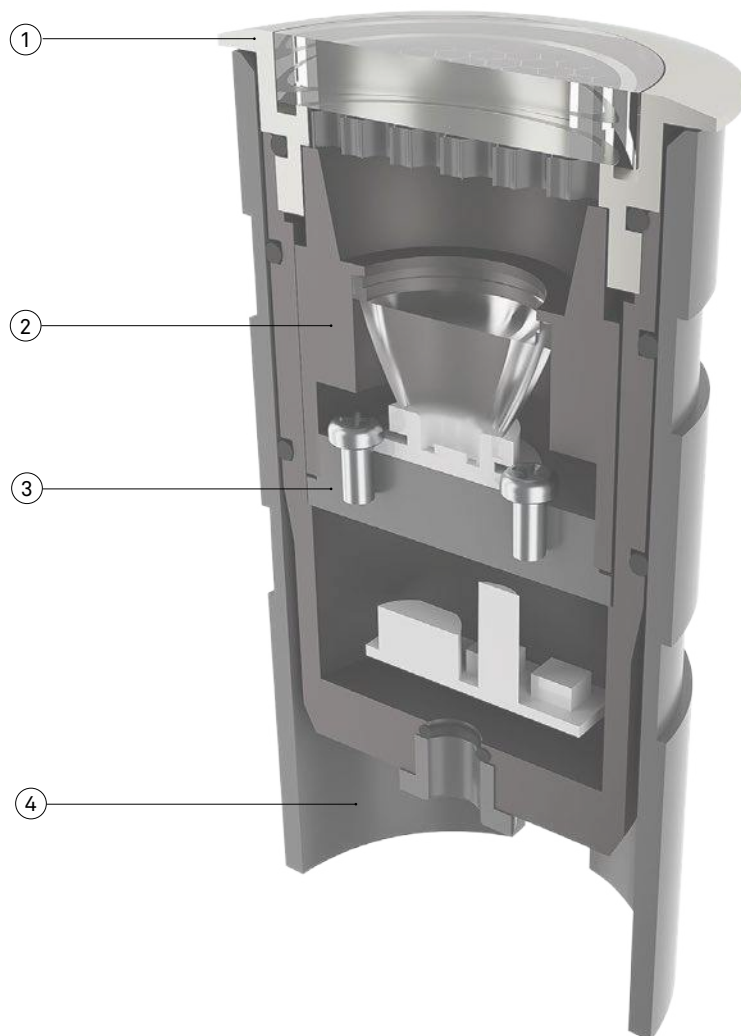

Perfekte Abdichtung Perfetta tenuta stagna

Außerdem sind ein externes Kabel und spezielle Stopfbuchsenabdichtung inbegriffen, um die Dichtigkeit und Zuverlässigkeit der Leuchte zu garantieren.

Include un cavo esterno e premistoppa speciale antiapertura, che garantiscono la tenuta e l'affidabilità dell'apparecchio.



IOS

los Symmetrical

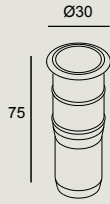

IP 65/67	IK 05				
-------------	----------	--	--	--	--

CA

LED						
K	CRI	W LED	W Total	Real Lm	Optics	Code
3000	80	2	4.1	94	Medium 29°	55-E148 - CA - CL

55-E148	IP		u. min	u. max	Code
	IP68	ON-OFF	1	4	71-E101-05-05
	IP67	ON-OFF	1	13	71-E159-00-00
	Optional IP66 IK09 box (300x200x105mm)				71-E100-00-00

P. 946

IP 65/67	IK 10				
-------------	----------	--	--	--	--

CA

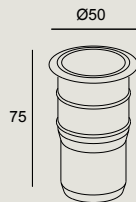

LED						
K	CRI	W LED	W Total	Real Lm	Optics	Code
3000	80	4	4.2	185	Medium 21°	55-E149 - CA - CL

55-E149	IP		u. min	u. max	Code
	IP68	ON-OFF	1	4	71-E101-05-05
	IP67	ON-OFF	1	13	71-E159-00-00
	Optional IP66 IK09 box (300x200x105mm)				71-E100-00-00

P. 946

IOS

los Asymmetrical

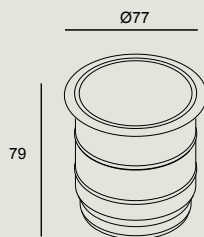

IP 65/67	IK 10				
-------------	----------	--	--	--	--

CA

LED						
K	CRI	W LED	W Total	Real Lm	Optics	Code
3000	80	5.8	6.3	203	Medium 38°	55-E150 - CA - CL

55-E150	IP		u. min	u. max	Code
	IP68	ON-OFF	1	3	71-E101-05-05
	IP67	ON-OFF	1	8	71-E159-00-00
	Optional IP66 IK09 box (300x200x105mm)				71-E100-00-00

P. 946

mitgeliefertes allgemeines Zub. Unterputzdose
Access. comuni inclusi Cassetta da incasso

nicht mitgeliefertes allgemeines Zub. Access. comuni non inclusi	IP68-Stecker mit 6 Eingängen Connettore IP68 a 6 ingressi	71-9199-05-05
	IP67-Stecker mit 3 Eingängen Connettore IP67 a 3 ingressi	71-9262-05-05
	IP68- Antikondensationsstecker mit 2 Eingängen Connettore IP68 con valvola anticondensa a 2 ingressi	71-E112-00-00
	IP68- Antikondensationsstecker mit 4 Eingängen Connettore IP68 con valvola anticondensa a 4 ingressi	71-E122-00-00



Pixel

BODY MAT	DIF MAT		50000h	3
AL,AISI316	GLA		L80 B20	MacAdam

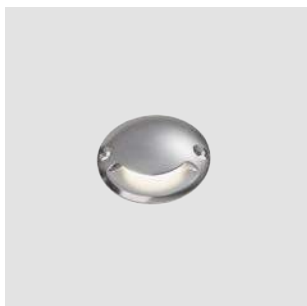

Video ansehen
Guarda il video

Eine Markierungskollektion mit starker Leistung, die einen bestimmten Bereich oder Durchgang durch verschiedene Lichteffekte vom Boden oder von der Wand abgrenzt. Pixel hat ein klares Design und kleine Abmessungen und ist in drei Formaten mit unterschiedlichen Lichtöffnungswinkeln erhältlich.

Collezione di segnaletica ad alte prestazioni studiata per delimitare una zona di transito, dal pavimento o dalla parete, mediante diversi effetti di luce. Pixel ha un design pulito con dimensioni ridotte, è disponibile in 3 formati, con differenti aperture di luce.

Visueller Komfort Comfort visivo

Dank der mit Fenstern versehenen Struktur mit der Leuchte und der versenkten Anordnung der LED blendet das Licht nicht, was zu einem höheren visuellen Komfort führt.

Grazie alla struttura con finestre di cui è dotato il corpo illuminante e alla disposizione ad incasso dei LED, la luce non abbaglia e genera un maggior comfort visivo.



Umfangreiches Sortiment Vasta gamma

Pixel ist in einer Größe und drei Formaten erhältlich. Mit einem, zwei und vier Fenstern oder Lichtstrahlöffnungen und in zwei Farbtemperaturen: 3000 K und 4000 K.

Pixel è disponibile in 1 misura e in 3 formati. Con 1, 2 e con 4 finestre o aperture del fascio di luce e in 2 temperature di colore: 3000K e 4000K.



Höchste Langlebigkeit und Widerstandsfähigkeit

Massima durabilità e resistenza

Mit einem Gehäuse aus AISI-316-Edelstahl und einem Glasdiffusor, die die Lebensdauer des Produkts maximieren und seine Installation in nassen Umgebungen oder sogar direkt am Meer ermöglichen. Die stabile Struktur ermöglicht die Installation auch in Bereichen mit Fahrzeugverkehr. Zudem sind spezielle Abdichtungsstopfen inbegriffen, um die Dichtigkeit und Zuverlässigkeit der Leuchte zu garantieren. Verfügt außerdem über eine spezielle Satinbehandlung zur Vermeidung von Kratzern, die dazu beiträgt, die Leuchte in perfektem Zustand zu halten. Ermöglicht Fahrzeugverkehr und verfügt über einen Stoßfestigkeitsgrad von IK10, der maximalen Widerstand garantiert. Dotato di un corpo in acciaio inox AISI 316 e un diffusore in vetro, per massimizzare la vita utile del prodotto e permettere la sua installazione in ambienti umidi o anche sul lungomare. La sua robusta struttura consente la sua installazione anche in zone a traffico veicolare. Inoltre, include premistoppa speciale antiapertura che garantisce la tenuta e l'affidabilità dell'apparecchio. Incorpora anche uno speciale trattamento satinato per evitare eventuali graffi, aiutando a mantenere l'apparecchio in perfette condizioni. Permette il passaggio di veicoli con un IK10, garantendo la massima resistenza.

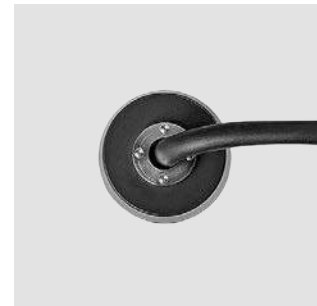

PIXEL

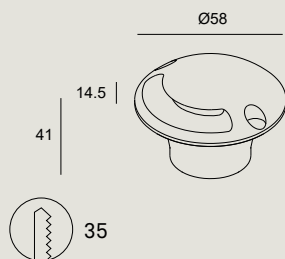

IP 65/67	IK 10				
-------------	----------	--	--	--	--

CA

LED					
K	CRI	W LED	Real Lm	Code	
3000	80	3.4	10	55-E001 - CA - CL	
4000	80	3.4	10	55-E001 - CA - CM	

24VDC

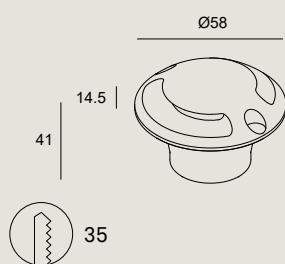

IP 65/67	IK 10				
-------------	----------	--	--	--	--

CA

LED					
K	CRI	W LED	Real Lm	Code	
3000	80	3.4	21	55-E002 - CA - CL	
4000	80	3.4	22	55-E002 - CA - CM	

24VDC

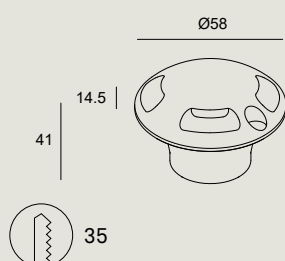

IP 65/67	IK 10				
-------------	----------	--	--	--	--

CA

LED					
K	CRI	W LED	Real Lm	Code	
3000	80	3.4	15	55-E003 - CA - CL	
4000	80	3.4	16	55-E003 - CA - CM	

24VDC

55-E001 55-E002 55-E003	IP		u. min	u. max	Code
	IP68	ON-OFF	1	4	71-E101-05-05
		ON-OFF	1	15	71-E159-00-00
	IP67	DALI	1	15	71-E098-00-00
		0-10V	1	10	71-E094-00-00
Optional IP66 IK09 box (300x200x105mm)					71-E100-00-00

P.946

mitgeliefertes allgemeines Zub. Access. comuni inclusi	Unterputzdose Cassetta da incasso	
nicht mitgeliefertes allgemeines Zub. Access. comuni non inclusi	IP68-Stecker mit 6 Eingängen Connettore IP68 a 6 ingressi	71-9199-05-05
	IP67-Stecker mit 3 Eingängen Connettore IP67 a 3 ingressi	71-9262-05-05
	IP68- Antikondensationsstecker mit 2 Eingängen Connettore IP68 con valvola anticondensa a 2 ingressi	71-E112-00-00
	IP68- Antikondensationsstecker mit 4 Eingängen Connettore IP68 con valvola anticondensa a 4 ingressi	71-E122-00-00
Smart Compatible-Zub. Access. Smart Compatibile	Driver Casambi PWM 1ch IP66	71-A242-00-00

Xena

DIF MAT
PC

Xena ist eine Kollektion von Bodeneinbauleuchten mit einem kompakten, zurückhaltenden und elegantem Design. Konzipiert zur Akzentuierung von Durchgangsbereichen mit einem Lichteffekt am Boden. Die Kollektion wird mit zwei Lichtquellen angeboten: LED und E-27. Sie beinhaltet bis zu 4 Kabelverschraubungen, um die Installation zu erleichtern. Des Weiteren besteht die Möglichkeit, die LED-Module als Ersatzteil zu bestellen, um somit eine Xena E27 in eine effizientere Leuchte umrüsten zu können. Dadurch wird die Verwendung in öffentlichen und intensiv genutzten Bereichen ermöglicht.

Xena è una collezione di faretti da incasso a pavimento con un design compatto, discreto ed elegante. Progettato per segnalare zone di transito, con un effetto di luce diretto verso il pavimento. La collezione è disponibile in due sorgenti luminose: LED ed E-27. Si offre con fino a 4 pressacavi per facilitare l'installazione ed esiste la possibilità di acquistare ricambi per i moduli LED che permettono di convertire una Xena E27 in un apparecchio più efficiente, favorendone così il suo utilizzo in spazi pubblici e ad uso intensivo.



**Maximale Widerstandsfähigkeit
und Lebensdauer**
Massima resistenza
e durabilità

Mit einem Gehäuse aus Aluminiumdruckguss und einem Polycarbonat diffuser wird die Lebensdauer des Produkts erhöht und eine Installation in nassen Umgebungen oder sogar direkt in Meeresnähe ermöglicht.

Dotato di un corpo in alluminio iniettato ed un diffusore in policarbonato nato per massimizzare la vita utile del prodotto e consentire la sua installazione in ambienti umidi o anche sul lungomare.



**Verwendung in
öffentlichen Bereichen**
Uso in spazi pubblici





Zur Erleichterung der Installation verfügt die Leuchte über 4 Kabelverschraubungen, die einzeln installiert werden können (2 für Kabel mit Ø 6 bis Ø 11 und 2 für Kabel mit Ø 8 bis Ø 16) sowie viel Platz für die Anschlüsse im Inneren der Leuchte.

Per facilitare l'installazione, questo modello è dotato di 4 pressacavi che possono essere installati singolarmente (2 per cavi da Ø6 a Ø11 e 2 per cavi da Ø8 a Ø16) e dispone di un ampio spazio per i collegamenti all'interno dell'apparecchio.



XENA

Xena LED

BODY MAT		IP	IK	50000h	3				SEA SIDE
AL		65/67	10	L80 B20	MacAdam	1800 Kg			SUITABLE



34 

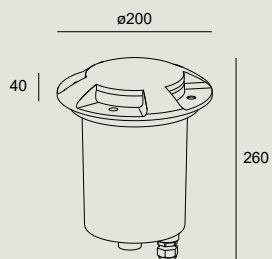

LED					
K	CRI	W LED	W Total	Real Lm	Code
3000	80	4.6	5.7	70	55-E102 - 34 - CL
4000	80	4.6	5.7	74	55-E102 - 34 - CM

 100-240V 50-60Hz

inklusive / Incluso

Unterputzdose
Cassetta da incasso

XENA

Xena E27

BODY MAT		IP	IK			SEA SIDE
AL_POLI						SUITABLE

34 

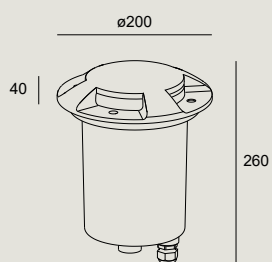

E27	
W	Code
max. 20	55-9428 - 34 - M3

inklusive / Incluso

Unterputzdose
Cassetta da incasso



Rim

BODY MAT	DIF MAT		50000h
AISI316	GLA		L80 B20



Video ansehen
Guarda il video

Rim ist Beleuchtung auf höchstem Niveau für zuverlässige Orientierungsbeleuchtung in höchster Qualität. Der beidseitig geschliffene Diffusor aus gehärtetem Glas sorgt für beispiellose Lichtqualität und eine perfekte Homogenität. Die Niederspannungsversorgung maximiert zudem die Sicherheit der Leuchte und ermöglicht eine steuerbare Installation in der Nähe von Brunnen und Schwimmbecken.

Rim è il massimo esponente dell'illuminazione di segnaletica, affidabile e di alta qualità. Il suo diffusore in vetro temperato con processo di sbiancamento su entrambi i lati conferisce un'ottima qualità ed omogeneità. Inoltre, l'alimentatore a bassa tensione massimizza la sicurezza dell'installazione e ne consente il montaggio in aree vicino a fontane e piscine, nonché la regolazione.

Weniger ist mehr
Meno è di più

Als Neuheit ist Rim in einer kleineren Größe mit 20 mm Durchmesser erhältlich, die sich vollständig in die Umgebung einfügen lässt und gleichzeitig alle Vorzüge der Kollektion bewahrt.

Come novità, Rim si presenta con un nuovo formato più piccolo di 20 mm di diametro che permette una totale integrazione nell'ambiente, preservando tutte le caratteristiche della collezione.

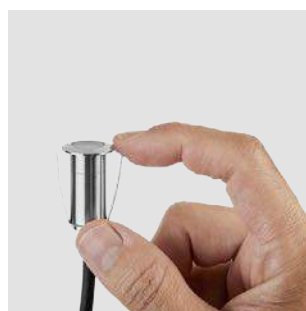

**Farbtemperatur warmweiss,
neutralweiss und blaues Licht**
**Temperatura calda,
neutra e luce blu**

Erhältlich in zwei Größen und in zwei Farbtemperaturen (3000 K und 4000 K). Die Ausführung mit 46 mm Durchmesser wird auch in einer Variante mit blauen LED angeboten, welche dank des guten Kontrasts in der Dunkelheit häufig zur Markierungsbeleuchtung eingesetzt werden.

Viene offerto in 2 misure con 2 temperature di colore (3000K e 4000K). La versione da 46 mm di diametro ha anche l'opzione di un LED blu, frequentemente utilizzato nella segnaletica, essendo il colore che ha il maggior contrasto al buio.



Maximale Lebensdauer **Massima durabilità**

Dank seiner zu 100 % aus Edelstahl AISI316 bestehenden Struktur ist das Produkt für Umgebungen aller Art geeignet, sogar in Meeresnähe. Die stabile Struktur ermöglicht die Installation auch in Bereichen mit Fahrzeugverkehr. Außerdem sind ein externes Kabel und spezielle Stopfbuchsenabdichtung inbegriffen, um die Dichtigkeit und Zuverlässigkeit der Leuchte zu garantieren.

La sua struttura realizzata al 100% in acciaio inox AISI 316, lo rende un prodotto adatto a tutti i tipi di ambienti, compreso il lungomare. La sua robusta struttura permette la sua installazione anche in zone a traffico veicolare. Inoltre, include un cavo esterno pressacavi speciale antiapertura, che garantisce la tenuta e l'affidabilità dell'apparecchio.



Niederspannung **Basso voltaggio**

Die Niederspannungsversorgung ermöglicht eine Steuerung der Leuchten und erhöht die Sicherheit der Anlage. Zudem ist eine Installation in der Nähe von Brunnen und Schwimmbecken möglich.

L'alimentazione a bassa tensione consente la regolazione e massimizza la sicurezza dell'installazione, permettendo, inoltre, il montaggio in aree vicino a fontane e piscine.

RIM

IP 66	IK 10				
----------	----------	--	--	--	--

CA

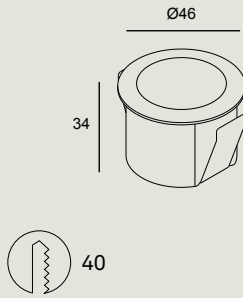

LED					
K	CRI	W LED	W Total	Real Lm	Code
3000	80	1	1.5	17	55-E151 - CA - CL
4000	80	1	1.5	17	55-E151 - CA - CM
Blue		1	1.5	3	55-E151 - CA - 11

24VDC

55-E151	IP		u. min	u. max	Code	
	IP68		ON-OFF	1	13	71-E101-05-05
			ON-OFF	1	14	71-E158-00-00
	IP67		DALI	1	30	71-E098-00-00
			0-10V	1	23	71-E096-00-00
Optional IP66 IK09 box (300x200x105mm)					71-E100-00-00	

P. 946

IP 65/67	IK 10	3 MacAdam				
-------------	----------	--------------	--	--	--	--

CA

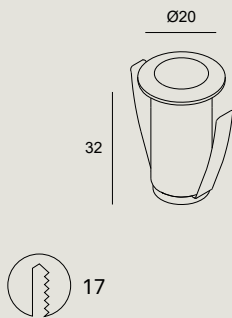

LED					
K	CRI	W LED	W Total	Real Lm	Code
3000	80	0.5	0.5	3	55-E006 - CA - CL
4000	80	0.5	0.5	4	55-E006 - CA - CM

24VDC

55-E006	IP		u. min	u. max	Code	
	IP68		ON-OFF	1	39	71-E101-05-05
			ON-OFF	1	45	71-E158-00-00
	IP67		DALI	1	30	71-E098-00-00
			0-10V	1	30	71-E094-00-00
Optional IP66 IK09 box (300x200x105mm)					71-E100-00-00	

P. 946

mitgeliefertes allgemeines Zub.
Access. comuni inclusi

Unterputzdose
Cassetta da incasso

Klemmen für Wandmontage
Morsetti per fissaggio a parete

nicht mitgeliefertes allgemeines Zub.
Access. comuni non inclusi

IP68-Stecker mit 6 Eingängen
Connettore IP68 a 6 ingressi **71-9199-05-05**

IP67-Stecker mit 3 Eingängen
Connettore IP67 a 3 ingressi **71-9262-05-05**

IP68- Antikondensationsstecker mit 2 Eingängen
Connettore IP68 con valvola anticondensa a 2 ingressi **71-E112-00-00**

IP68- Antikondensationsstecker mit 4 Eingängen
Connettore IP68 con valvola anticondensa a 4 ingressi **71-E122-00-00**

Smart Compatible-Zub.
Access. Smart Compatibile

Driver Casambi PWM 1ch IP66 **71-A242-00-00**



Uplights für Aufsatzmontage

Uplight di superficie



Soul

683

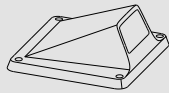

Rxel

686

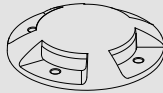

Xena

688



Soul

BENEDITO DESIGN 2021

BODY MAT	DIF MAT	50000h	3
AL	GLA	L80 B20	MacAdam



Video ansehen
Guarda il video

Vielseitige und professionelle Kollektion von Uplights und Downlights für den Aufputzeinbau mit ultraflachem und sauberem Design und hervorragender Farbwiedergabe durch mitgelieferte CRI90-Leuchtmittel. Ohne sichtbare Verschraubungen und mit hohem visuellem Komfort wurde sie für die Beleuchtung in Projekten mit anspruchsvoller architektonischer Integration entwickelt. Soul ist eine Kollektion zur Beleuchtung von Pflanzen, Denkmälern, Säulen oder sonstigen architektonischen Elementen, wenn es keine Möglichkeit zum versenkten Einbau oder zur Entwässerung gibt. Die Leuchten sind mit integriertem EIN-AUS-Schalter, DALI oder Casambi lieferbar und erleichtern so die Installation. Es gibt sie in zwei Durchmessern, mit 20 und 26 cm, mit verschiedener Leistung, drei Farbtemperaturen (2700K, 3000K und 4000K) und drei Lichtaustrittswinkeln (18°, 35° und 49°). Mit dem als Zubehör erhältlichen Filter kann ein Wall-Washer-Effekt erzeugt werden.

Collezione di faretto uplight e downlight di superficie, versatili e professionali, dal design ultrapiatto e pulito, senza bulloneria a vista e con un grande comfort visivo, pensata per illuminare progetti con un'eccellente integrazione architettonica e un'elevata riproduzione cromatica grazie al CRI90 di serie. Soul è una collezione progettata per illuminare piante, monumenti, colonne o altri elementi architettonici senza fori e senza la necessità di creare drenaggi. È disponibile con dispositivo ON-OFF, DALI o Casambi integrato all'interno dell'apparecchio, che lo rende più facile da installare. È disponibile in due diametri, 20 e 26 cm, offre varie potenze, 3 temperature di colore (2700K, 3000K e 4000K) e 3 angoli di luce (18°, 35° e 49°). Dispone di un accessorio di filtro opzionale per dirigere la luce e ottenere un effetto wallwasher.

Höchster visueller Komfort Massimo comfort visivo

Die Konfiguration mit einzelnen versenkten optischen Modulen sorgt für eine einheitliche Ausleuchtung und hohen visuellen Komfort. Dies erzeugt einen Dark-Light-Effekt. Dieser Effekt entsteht, wenn trotz eingeschalteter Leuchte der Eindruck erweckt wird, dass diese ausgeschaltet ist.

La sua configurazione, con singoli moduli ottici incassati, garantisce un'illuminazione omogenea, un grande comfort visivo e crea un effetto Dark Light. Questo effetto si verifica quando la lampada, anche se accesa, sembra essere spenta.

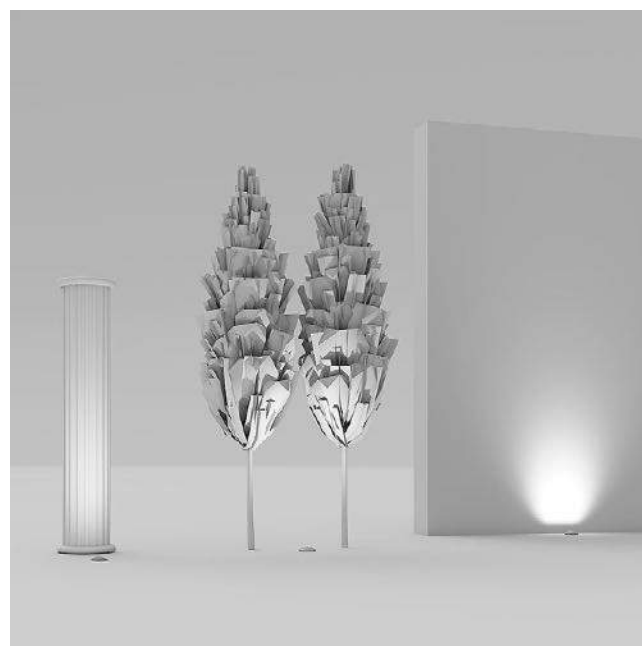

15° symmetrisch - 30° symmetrisch - 49° asymmetrisch/wall washer

15° simmetrici - 30° simmetrici - 49° asimmetrici/wall washer

**Höchste Langlebigkeit
und Widerstandsfähigkeit**
Massima durabilità
e resistenza

Bestehend aus einem Aluminiumdruckgussgehäuse, einem AISI316-Edelstahlsockel und einem Glasdiffusor. Diese Komponenten erhöhen die Lebensdauer des Produkts und ermöglichen eine Installation in nassen Umgebungen oder sogar direkt in Meeresnähe. Zusätzlich verfügt sie über einen doppelten Kabelausgang, um die Installation in Reihe zu vereinfachen. Dotato di un corpo in alluminio iniettato, base in acciaio inox AISI316 e un diffusore in vetro, per massimizzare la vita utile del prodotto e permettere la sua installazione in ambienti umidi o anche sul lungomare. Dispone inoltre di una doppia uscita del cavo per facilitare l'installazione in serie.



Einfache Installation
Installazione facile

Einfache Installation auf dem Boden, ohne dass die Leuchte eingebaut oder für Wasserabfluss gesorgt werden muss. Wird auf einer stabilen konischen Platte montiert, die wiederum das Gehäuse der Leuchte aufnimmt.

Facile montaggio a terra, senza la necessità di incassare l'apparecchio o di drenare. Montaggio su una resistente piastra conica, che a sua volta ospita il corpo dell'apparecchio.



Zubehör
Accessori

Mit einem asymmetrischen Diffusor-Filter von Jungbecker als Zubehör, der einen perfekten Wall-Washer-Effekt erzeugt.

Dispone di un accessorio di filtro diffusore asimmetrico Jungbecker che produce un perfetto effetto Wall Washer.



SOUL

IP 66/67	IK 10	1000 Kg		SEA SIDE SUITABLE	BREEAM
-------------	----------	---------	--	----------------------	--------

Codebeispiel / Esempio di codice: AL11-P6V9S2OUZ5

Model	W	K/ CRI/ Real lm	Optics	Source	Finishes
AL11 - 	P6 6.1W	V9 2700K/CRI90 425 lm	S2 18°	OU ON-OFF 100-277V 50-60Hz	Z5
		W9 3000K/CRI90 417 lm	M3 35°	BB 9V/Max. 700mA	
		X9 4000K/CRI90 462 lm	F1 49°		

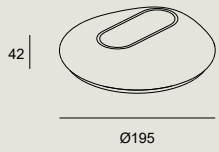

42 | Ø195

AL11	IP		u. min	u. max		Code
				220-240V	110-127V	
IP68	ON-OFF		1	1	1	71-E014-00-00
	DALI		1	4	2	71-E080-00-00
	0-10V		1	2	2	71-E081-00-00
IP70	ON-OFF		1	8	6	71-3542-00-00
	DALI		1	8	6	71-4706-00-00
	0-10V		1	8	6	71-4706-00-00
Optional IP66 IK09 box (300x200x105mm)						71-E100-00-00

ⓘ P 946

nicht inklusive / Non incluso	
Asymmetrischer Lichtstrahlfilter Filtro per fascio di luce asimmetrico	71-E200-00-00

	IP 66/67	IK 10	1000 Kg		SEA SIDE SUITABLE	BREEAM	
--	-------------	----------	---------	--	----------------------	--------	--

Model	W	K/ CRI/ Real lm	Optics	Source	Finishes
AL12 - 	18 18.3W	V9 2700K/CRI90 1301 lm	S2 16°	OU ON-OFF/100-277V 50-60Hz	Z5
		W9 3000K/CRI90 1301 lm	M3 33°	DS DALI-2/220-240V 50-60Hz	
		X9 4000K/CRI90 1301 lm	F1 48°	XB CASAMBI 220-240V 50-60Hz	
				BB 26.5V/Max. 700mA	

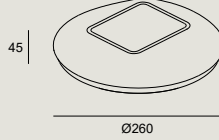
45 | Ø260

AL12	IP		u. min	u. max		Code
				220-240V	110-127V	
IP68	ON-OFF		1	1	1	71-E015-00-00
	DALI		1	1	1	71-E086-00-00
	0-10V		1	1	1	71-E086-00-00
IP20	ON-OFF		1	2	2	71-3542-00-00
	DALI		1	2	2	71-4706-00-00
	0-10V		1	2	2	71-4706-00-00
Optional IP66 IK09 box (300x200x105mm)						71-E100-00-00

ⓘ P 946

nicht inklusive / Non incluso	
Asymmetrischer Lichtstrahlfilter Filtro per fascio di luce asimmetrico	71-E227-00-00

Rexel

FRANCESCO VILARÓ 2016

BODY MAT	DIF MAT		50000h	3
AL	PMMA		L80 B20	MacAdam



Äußerst kompakte LED-Bodenaufbauleuchte, unerlässlich für die Markierung und Ausleuchtung von Durchgängen. Unauffällig dank einer Höhe von nur 75 mm, bietet sie dennoch die Möglichkeit, das Licht so auszurichten, dass der gesamte Durchgangsbereich perfekt geflutet wird. Ein weiteres bedeutendes Merkmal ist der im Gehäuse integrierte Treiber. Durch die Aufbauinstallation ist keine Unterputzdose und Drainage erforderlich und die Dichtigkeit gewährleistet.

Faretto compatto indispensabile per illuminare le zone di transito. Con un'altezza di soli 75mm, rimane inosservato, ma, nonostante ciò, offre la possibilità di direzionare il fascio di luce per ottenere un perfetto wallwasher della zona di transito. Un'altra delle sue notevoli caratteristiche è quella di incorporare il driver all'interno del corpo in superficie, in modo che la sua installazione non richieda una scatola da incasso e garantisca la tenuta stagna, senza la necessità di alcun tipo di drenaggio.

Manuelle Verstellung Controllo e regolazione manuale

Bietet die Möglichkeit, den Lichtaustritt auszurichten. So kann der Boden mit Streiflicht beleuchtet werden. Dies ist ein hervorragendes Designtool um besondere Effekte zu erzeugen.



Dispone di un blocco ottico che offre la possibilità di direzionare il fascio luminoso, permettendo di creare effetti luminosi a filo sul pavimento.



Zwei Größen Due misure

Erhältlich in zwei Modellen unterschiedlicher Größe und Leistung sowie in zwei Farbtemperaturen (3000 K und 4000 K). È disponibile in 2 modelli di diverse dimensioni e potenze e in 2 temperature di colore (3000K e 4000K).



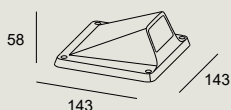

IP	IK		SEA SIDE		BREEAM
65/67	10	0° a 15°	SUITABLE	ON-OFF	

Z5 ●



LED					
K	CRI	W LED	W Total	Real Lm	Code
3000	80	2.1	3.4	144	55-9883 - Z5 - CL
4000	80	2.1	3.4	198	55-9883 - Z5 - CM
 100-240V		50-60Hz			

IP	IK		SEA SIDE		BREEAM
66/67	09	0° a 15°	SUITABLE	ON-OFF	

Z5 ●

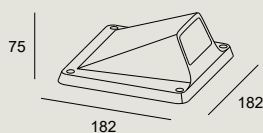

LED					
K	CRI	W LED	W Total	Real Lm	Code
3000	80	4.3	5.5	281	55-9741 - Z5 - CL
4000	80	4.3	5.5	281	55-9741 - Z5 - CM
 100-240V		50-60Hz			

Xena LED

BODY MAT	DIF MAT		50000h	3
AL	PC		L80 B20	MacAdam

Bodenaufbauleuchte mit zurückhaltendem und elegantem Design. Xena LED Surface wurde entwickelt, um Durchgangsbereiche mit interessanten Lichteffekten auszuleuchten. Die Funktionalität beruht auf der einfachen Montage. Eine Unterputzdose ist nicht erforderlich, da alle Bauteile in der Leuchte integriert sind.

Un faretto con un design discreto ed elegante, Xena LED Surface è progettato per segnalare le zone di transito pedonale attraverso suggestivi effetti di luce. La sua funzionalità risiede nella sua facile installazione dovuto al fatto di non richiedere una scatola da incasso, incorporando l'alimentatore all'interno.



Verschiedene Optionen Diverse opzioni

Erhältlich mit verschiedenen Lichtaustrittsöffnungen (1, 2 und 4), in Farbtemperatur 4000 K und inklusive Zubehörfilter zur Umrüstung auf 3000 K.

Questo modello viene fornito con diverse aperture di uscita della luce (1, 2 e 4), in 1 temperatura di colore, di 4000K. Include un filtro accessorio per modificare la temperatura a 3000K.



Maximale Lebensdauer Massima durabilità

Hergestellt aus Aluminium, das vor dem Lackieren einer doppelten chemischen Behandlung und Sandstrahlung unterzogen wurde, um eine die Installation in nassen Umgebungen oder sogar direkt in Meeresnähe zu ermöglichen. Beständig gegen bis zu 800 kg Gewicht.

Dotato di un corpo in alluminio con doppio trattamento chimico e sabbiatura, prima della verniciatura, per massimizzare la vita del prodotto e consentire la sua installazione in ambienti umidi o anche sul lungomare. Resiste fino a 800 kg di peso.



Einfache Installation Installazione facile

Doppelter Kabelausgang, um die Installation zu vereinfachen. Eine Drainage ist nicht erforderlich.

Include una doppia uscita del cavo per facilitare l'installazione. Non necessita di foro da incasso o di drenaggio.

XENA LED

IP 66	IK 10	800 Kg		SEA SIDE SUITABLE	ON-OFF
----------	----------	--------	--	----------------------	--------

34

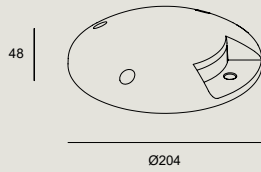

LED					
K	CRI	W LED	W Total	Real Lm	Code
4000	80	1.5	2	42	55-9945 - 34 - CM
100-240V		50-60Hz			

IP 66	IK 10	800 Kg		SEA SIDE SUITABLE	ON-OFF
----------	----------	--------	--	----------------------	--------

34

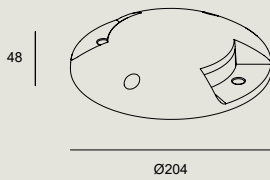

LED					
K	CRI	W LED	W Total	Real Lm	Code
4000	80	3	5	70	55-9946 - 34 - CM
100-240V		50-60Hz			

IP 65	IK 10	800 Kg		SEA SIDE SUITABLE	ON-OFF
----------	----------	--------	--	----------------------	--------

34

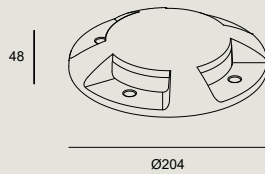

LED					
K	CRI	W LED	W Total	Real Lm	Code
4000	80	6	8.2	148	55-9947 - 34 - CM
100-240V		50-60Hz			

mitgeliefertes allgemeines Zub. 3000-K-Filter
Access. comuni inclusi Filtro 3000K



Pollerleuchten

Faretti

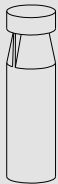

Rek
693



Compact
700



Row
703



Simenti
706



Modis
708



Newton
711



Cilin
717



Dan
719



Lyon
723



Cubik
724



Nott
728

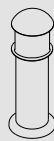

Balizas
730

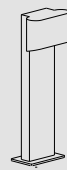

Diago
732



Priap
733



Helion
734



Cubus
734



Way
735



Invisible
736



Juncus
739



Rek

BODY MAT	DIF MAT		50000h	3
AL	PC		L80 B20	MacAdam



Einen Gehweg mit mehr als 20 Lux und einer Gleichmäßigkeit von über 40 % bei einem Leuchtpfostenabstand von 5 Metern auszuleuchten, ist eine große Leistung. Diese Vorgaben mussten bei der Entwicklung der Kollektion eingehalten werden, um die Vorschriften der spanischen Technischen Bauordnung (CTE) zu erfüllen. Rek ist eine Neuheit im Outdoor-Katalog und eine ernstzunehmende Alternative, da durch die ausgefeilte Technologie im Vergleich zu herkömmlichen Modellen für die vollständige Ausleuchtung eines Weges eine geringere Anzahl Leuchten erforderlich sind, was zudem noch mit beeindruckender Gleichmäßigkeit gelingt. Auch den technischen Aspekten wurde große Aufmerksamkeit gewidmet, um die Kollektion optimal gegen Wind und Wetter zu rüsten. Rek verfügt serienmäßig über ein Antikondensationsventil, einen hervorragenden Schutz gegen das Eindringen von Staub und Hochdruckwasser (IP66), hohe Stoßfestigkeit (IK10) und kann dank des hochwertigen Aluminiumwerkstoffs und der KTL-Grundierung sogar in rauer Seeluft aufgestellt werden.

Riuscire a illuminare una zona di passaggio con oltre 20 lux e un'uniformità superiore al 40% con luci a una distanza di 5 metri una dall'altra, è una sfida con la s maiuscola. Questi parametri costituiscono la ragion d'essere della collezione in vista del rispetto della normativa di costruzione richiesta dal Codice tecnico della costruzione. Rek è una novità del catalogo Outdoor che si presenta come alternativa di grande valore, in quanto le sue avanzate caratteristiche tecniche consentono di illuminare completamente la strada con un numero inferiore di faretti, rispetto ad altri modelli più classici, con la garanzia di una perfetta omogeneità della zona da illuminare. Anche gli aspetti tecnici sono stati profondamente curati, per ottenere una collezione ultra resistente alle condizioni più avverse. Rek dispone di una valvola anticondensa inclusa di serie, un'eccellente protezione contro l'ingresso di polvere e acqua ad alta pressione (IP66), una grande resistenza agli urti (IK10) e può essere installata anche in ambienti con atmosfera marina grazie alla qualità dell'alluminio e al processo di verniciatura in cataforesi.

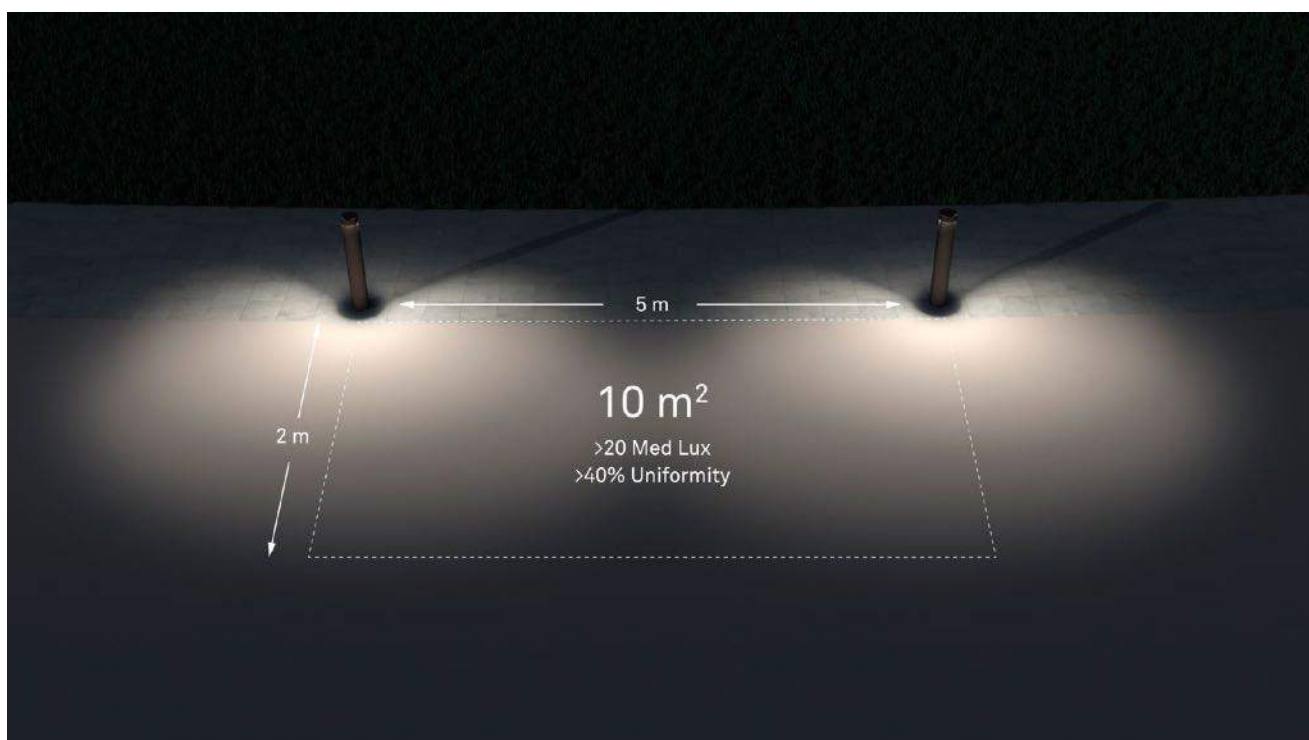

Vorteile des größeren Abstands Benefici di una maggiore interdistanza

Die Tatsache, dass Rek einen Gehweg bei einem Leuchtenabstand von 5 Metern mit durchschnittlich >20 Lux und einer Gleichmäßigkeit von 40 % hervorragend beleuchtet, macht die Kollektion zu einer Alternative mit hohem Mehrwert.

Hier einige weitere Vorteile:

- Verbesserte architektonische Einbindung, da die geringere Leuchtpostenanzahl weniger abrupt in die Landschaft wirkt
- Höhere Energieeinsparung (35 % geringerer Stromverbrauch im Gesamtprojekt gegenüber herkömmlichen Gehwegleuchten)
- Eine erhebliche Einsparung bei den Gesamtkosten, sowohl bei den Leuchten als auch bei der Installation

Und das beste ist, dass neben all diesen Vorteilen auch noch ein überragendes Beleuchtungsergebnis erzielt wird.

La capacità di illuminare zone di passaggio con un'interdistanza di 5 metri, una media >20 lux e un'uniformità del 40% rende Rek una scelta con molti vantaggi.

I vantaggi sono:

- Una maggiore integrazione architettonica, poiché con meno faretti non si interviene in modo brusco sul paesaggio
- Un maggiore risparmio energetico (con il 35% in meno di consumo del progetto totale rispetto a faretti per zone di passaggio tradizionali)
- Un notevole risparmio nel costo totale, sia degli apparecchi che della loro installazione

E la cosa migliore è che, indipendentemente da questi vantaggi, si ottiene un eccellente risultato totale di illuminazione.



Pollerleuchten Rek / Faretti Rek

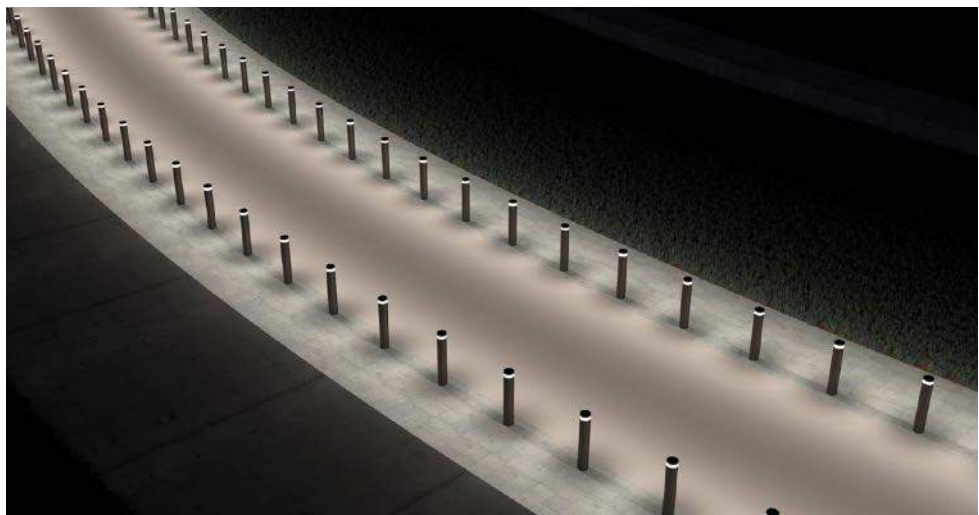

Konventionell Pollerleuchten / Faretti convenzionali

Umfassendes Angebot Ampia gamma

Die Rek-Kollektion ist das umfangreichste Leuchtpfostenangebot im Produktprogramm von C4 LEDS. Neben der Wahl der Farbtemperatur zwischen 2700K, 3000K und 4000K sind die Modelle mit 360°- oder 180°-Ausleuchtung, in zwei verschiedenen Bauhöhen (45 cm und 90 cm) und nicht zuletzt mit verschiedenen Treibern (EIN/AUS, DALI oder Casambi) erhältlich.

La collezione Rek è la collezione di faretti più ampia del portafoglio LEDS C4. Non solo consente di scegliere la temperatura di colore tra 2700K, 3000K e 4000K, ma permette anche di scegliere tra illuminazione a 360° e 180°, due diverse altezze (45 cm o 90 cm) e perfino il tipo di driver (ON/OFF, DALI o Casambi).



90 cm - 360°



45 cm - 180°

Verfügbare Farben Colori disponibili

Rek wird standardmäßig in der Farbe Anthrazitgrau geliefert und ist außerdem in dem Farbtönen der individuellen Farbpalette The Colours von LEDS C4 erhältlich.

Rek è disponibile nel colore grigio antracite di serie e anche nella gamma personalizzata The Colours di LEDS C4.



Visueller Komfort Comfort visivo

Die Konstruktion des optischen Moduls der Rek-Modelle besteht aus asymmetrischen Linsen, die strategisch in den Kopf eingelassen sind, um der Lichtverschmutzung vorzubeugen und einen hervorragenden Lichtkomfort zu liefern.

Il design del modulo ottico di Rek dispone di lenti asimmetriche strategicamente inserite all'interno della testa per garantire una contaminazione luminosa nulla e un eccellente comfort visivo.



Pro-Base-System Pro-base System



Rek verfügt über das Pro-Base-Befestigungssystem, das eine perfekte Installation und eine größere Stabilität und Haltbarkeit der Leuchte gewährleistet.

100 % integriert. Der Sockel ist vollständig in der Leuchte verborgen.

100 % geschützt. Mit Technopolymerschicht, die den Sockel vor direktem Kontakt mit dem Boden isoliert und so ein Verkratzen des Aluminiums während der Installation verhindert.

100 % stabil. Der Sockel besteht aus besonders dickem Aluminium, um Schwachstellen zu vermeiden und kann in privaten, öffentlich genutzten Bereichen wie auch Einkaufszentren oder Hotels installiert werden.

100 % zur Installation in Meeresnähe geeignet. Die äußere Aluminiumschicht wird durch ein spezielles Verfahren verstärkt, was eine Oxidation des Aluminiums verhindert.

100 % aufrecht. 3 zusätzliche Bohrungen sorgen dafür, dass alle Poller während der Installation absolut gerade ausgerichtet sind und sich in keine Richtung neigen.

Rek dispone del sistema di fissaggio Pro-base system, che garantisce una perfetta installazione, insieme a una maggiore stabilità e durata dell'apparecchio.

Integrato al 100%. Base totalmente nascosta all'interno del faretto.

Protetto al 100%. È inclusa una piastra in tecnopolimero per isolare la base dal contatto diretto con il terreno, evitando così eventuali graffi sull'alluminio, durante l'installazione.

Stabile al 100%. Base realizzata in alluminio, di maggior spessore, per evitare punti deboli; si può installare in aree private di uso pubblico come centri commerciali o hotel.

Adatto al 100% per il lungomare. Processo speciale per rinforzare lo strato esterno di alluminio, prevenendone l'ossidazione.

100% dritto. Sono inclusi 3 fori extra per assicurare che i faretto rimangano assolutamente dritti durante l'installazione, senza alcuna inclinazione.

Smart

Die Rek-Kollektion ist mit einem Bluetooth-Mesh-Gerät mit Casambi-Technologie ausgestattet, das eine individuelle Ansteuerung der einzelnen Leuchten trotz konventioneller Verkabelung mit Phase, Neutral- und Schutzleiter ermöglicht. La collezione Rek integra un dispositivo Bluetooth Mesh con tecnologia Casambi, il che rende possibile il controllo individuale di ciascuno degli apparecchi con un'installazione tradizionale Fase, Neutro e Terra.



Smart-Funktion:
Zeitliche Programmierung
Funzionalità Smart:
Programmazioni orarie

Der Leuchtpfosten Rek kann über die Casambi-APP ferngesteuert werden und Funktionen wie das Ein- und Ausschaltprogramm nach einem festgelegten Zeitplan ausführen. Dies ist in Durchgangsbereichen, in denen die Leuchte normalerweise aufgestellt wird, unerlässlich.

Il faretto Rek può essere gestito da remoto tramite la APP di Casambi e svolgere funzioni come la programmazione di accensione e spegnimento in base a un orario prestabilito, indispensabile in zone di passaggio dove normalmente questa luce viene collocata.



REK

Rek 180° emission

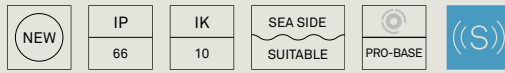

14* ○ 34* ● 60* ● DL* ● E3* ● J6* ● Z5 ●

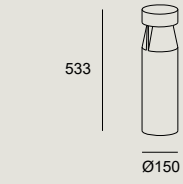

LED						
K	CRI	W LED	W Total	Real Lm	Code	
2700	80	11.4	13.7	325	14	34
					55-E025	60
					55-E026 - DL - CK	E3
					55-E027	J6
						Z5
3000	80	11.4	13.7	325	14	34
					55-E025	60
					55-E026 - DL - CL	E3
					55-E027	J6
						Z5
4000	80	11.4	13.7	325	14	34
					55-E025	60
					55-E026 - DL - CM	E3
					55-E027	J6
						Z5

55-E025	ON-OFF	100-240V	50-60Hz
55-E026	DALI-2	220-240V	50-60Hz
55-E027	Casambi	220-240V	50-60Hz

REK

Rek 360° emission

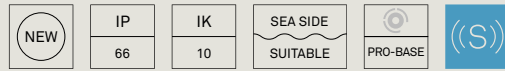

14* ○ 34* ● 60* ● DL* ● E3* ● J6* ● Z5 ●

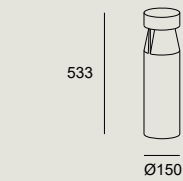

LED						
K	CRI	W LED	W Total	Real Lm	Code	
2700	80	23.5	27	650	14	34
					55-E028	60
					55-E029 - DL - CK	E3
					55-E030	J6
						Z5
3000	80	23.5	27	650	14	34
					55-E028	60
					55-E029 - DL - CL	E3
					55-E030	J6
						Z5
4000	80	23.5	27	650	14	34
					55-E028	60
					55-E029 - DL - CM	E3
					55-E030	J6
						Z5

55-E028	ON-OFF	100-240V	50-60Hz
55-E029	DALI-2	220-240V	50-60Hz
55-E030	Casambi	220-240V	50-60Hz

*Fragen Sie unser Verkaufsteam nach den Lieferbedingungen.

Consultare i termini e le condizioni di consegna al nostro team commerciale.

REK

Rek 180° emission



14* 34* 60* DL* E3* J6* Z5

933



Ø150



180°

LED						
K	CRI	W LED	W Total	Real Lm	Code	
2700	80	16.6	19.5	459	14	
					34	
					60	55-E031 - DL - CK
					E3	55-E032
					J6	55-E033
3000	80	16.6	19.5	459	14	
					34	
					60	55-E031 - DL - CL
					E3	55-E032
					J6	55-E033
4000	80	16.6	19.5	459	14	
					34	
					60	55-E031 - DL - CM
					E3	55-E032
					J6	55-E033
					Z5	

	55-E031	ON-OFF	100-240V	50-60Hz
	55-E032	DALI-2	220-240V	50-60Hz
	55-E033	Casambi	220-240V	50-60Hz

REK

Rek 360° emission



14* 34* 60* DL* E3* J6* Z5

933



Ø150



360°

LED						
K	CRI	W LED	W Total	Real Lm	Code	
2700	80	35.9	40	918	14	
					34	
					60	55-E035 - DL - CK
					E3	55-E036
					J6	55-E037
3000	80	35.9	40	918	14	
					34	
					60	55-E035 - DL - CL
					E3	55-E036
					J6	55-E037
4000	80	35.9	40	918	14	
					34	
					60	55-E035 - DL - CM
					E3	55-E036
					J6	55-E037
					Z5	

	55-E035	ON-OFF	100-240V	50-60Hz
	55-E036	DALI-2	220-240V	50-60Hz
	55-E037	Casambi	220-240V	50-60Hz

nicht mitgeliefertes
allgemeines Zub.
Access. comuni non inclusi

Befestigungsbolzen
Perni di fissaggio

71-E092-48-48

Compact

BODY MAT	DIF MAT		50000h	3
AL	PC		L80 B20	MacAdam



**Hohe Effizienz und
Lichtqualität**
Alta efficienza e
qualità della luce

Im kompakten Leuchtengehäuse befindet sich eine sehr leistungsstarke Lichtquelle, die den Lichtbedarf jedes Raums erfüllt und damit die Umgebung vollkommen in den Mittelpunkt stellt. Der Leuchteninnenraum ist vollkommen leer und flutet sich mit Licht, wenn die Leuchte eingeschaltet wird. Das verleiht der Leuchte einen besonderen Charakter.

Faretto modulare con una sorgente luminosa molto potente, integrata nel suo corpo compatto, per soddisfare le esigenze di illuminazione di qualsiasi progetto, concedendo tutto il protagonismo all'ambiente. L'interno, totalmente vuoto, si illumina completamente quando viene acceso, rendendolo un pezzo molto originale.

Eine hocheffiziente Osram-LED-Lichtquelle gewährleistet eine optimale Lichtqualität.

Offre una sorgente luminosa Osram LED che garantisce un'alta efficienza e un'ottima qualità della luce.



Modularität
Modularità

Verschiedene Optionen für eine Lichtlenkung in eine, zwei, drei oder vier Richtungen

Possibilità di dirigere l'emissione luminosa in una, due, tre o quattro direzioni.



Maximale Lebensdauer
Massima durabilità

Hergestellt aus Aluminium für ein perfektes Wärmemanagement und eine lange Lebensdauer.

Compact è realizzato in alluminio, facilitando la perfetta dissipazione del calore e massimizzando la vita utile del prodotto.

COMPACT

IP	IK		SEA SIDE	
65	10		SUITABLE	ON-OFF

Z5 ●

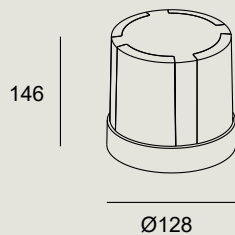

LED					
K	CRI	W LED	W Total	Real Lm	Code
3000	80	10.8	11.2	532	10-9994 - Z5 - CL
 100-240V		50-60Hz			

IP	IK	SEA SIDE	
65	10	SUITABLE	ON-OFF

Z5 ●

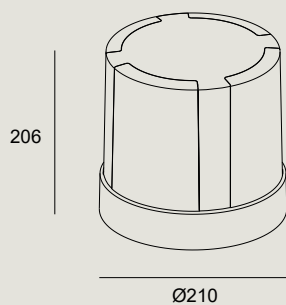

LED					
K	CRI	W LED	W Total	Real Lm	Code
3000	80	17	19.3	835	10-9847 - Z5 - CL
 100-240V		50-60Hz			



Row

BODY MAT	DIF MAT		50000h	3
CON	PC		L80 B20	MacAdam



Hervorragender Sehkomfort Grande comfort visivo

Diese Produktreihe der Deco-Tech-Pollerleuchten bildet die perfekte Symbiose aus Hochleistungs-LED mit hohem Lichtstrom und zeitgenössischem Design. Mit dem Ziel, die Leuchte optimal in ihre Umgebung zu integrieren, ist Row aus Zement gefertigt, wodurch sie sich vollständig in die Außenarchitektur einfügt.

Questa collezione di faretto Deco-Tech rappresenta la combinazione perfetta tra una soluzione LED ad alto flusso luminoso ed un prodotto con un design contemporaneo. Con l'obiettivo di integrare il più possibile l'apparecchio nello spazio, Row viene realizzato in cemento, permettendo che si integri completamente con l'architettura esterna.

Durch die Platzierung der LED im oberen Teil des Leuchtenkopfes und die Neigung des Diffusors, deckt der nach unten gelenkte Lichtstrahl eine größere Fläche ab und verhindert jegliche Blendung.

Progettato per offrire un grande comfort visivo, il posizionamento dei LED nella parte superiore della testa, insieme all'inclinazione del diffusore, fanno sì che il fascio luminoso raggiunga un'area più ampia e sia diretto verso il basso, evitando così eventuali abbagliamenti.

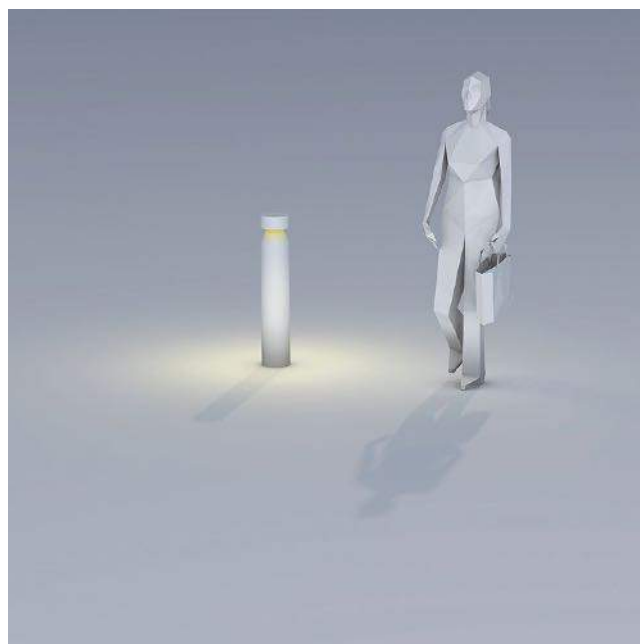

Trendige Optik Finitura di tendenza

Die moderne Zementoptik von Row ermöglicht eine stilvolle Integration in architektonische und gewerbliche Räume.

Row è disponibile con una finitura cemento che gli consente di mimetizzarsi completamente in spazi architettonici e industriali.



Pro-Base-System Pro-base System



Row verfügt über das Pro-Base-Befestigungssystem, das eine perfekte Installation und eine größere Stabilität und Haltbarkeit der Leuchte gewährleistet.

100 % integriert. Der Sockel ist vollständig in der Leuchte verborgen.

100 % geschützt. Mit Technopolymerschicht, die den Sockel vor direktem Kontakt mit dem Boden isoliert und so ein Verkratzen des Aluminiums während der Installation verhindert.

100 % stabil. Der Sockel besteht aus besonders dickem Aluminium, um Schwachstellen zu vermeiden und kann in privaten, öffentlich genutzten Bereichen wie auch Einkaufszentren oder Hotels installiert werden.

100 % zur Installation in Meeresnähe geeignet. Die äußere Aluminiumschicht wird durch ein spezielles Verfahren verstärkt, was eine Oxidation des Aluminiums verhindert.

100 % aufrecht. 3 zusätzliche Bohrungen sorgen dafür, dass alle Poller während der Installation absolut gerade ausgerichtet sind und sich in keine Richtung neigen.

Row dispone del sistema di fissaggio Pro-base system, che garantisce una perfetta installazione, insieme a una maggiore stabilità e durata dell'apparecchio.

Integrato al 100%. Base totalmente nascosta all'interno del faretto.



Protetto al 100%. È inclusa una piastra in tecnopolimero per isolare la base dal contatto diretto con il terreno, evitando così eventuali graffi sull'alluminio, durante l'installazione.

Stabile al 100%. Base realizzata in alluminio, di maggior spessore, per evitare punti deboli; si può installare in aree private di uso pubblico come centri commerciali o hotel.

Adatto al 100% per il lungomare. Processo speciale per rinforzare lo strato esterno di alluminio, prevenendone l'ossidazione.

100% dritto. Sono inclusi 3 fori extra per assicurare che i faretti rimangano assolutamente dritti durante l'installazione, senza alcuna inclinazione.



ROW

IP 65	IK 10		SEA SIDE SUITABLE			BREEAM
----------	----------	--	----------------------	--	---	--------

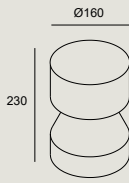
DC 



LED					
K	CRI	W LED	W Total	Real Lm	Code
3000	80	17.4	19.3	1071	10-E055 - DC - CL
 100-277V		50-60Hz			

IP 65	IK 10		SEA SIDE SUITABLE			BREEAM
----------	----------	---	----------------------	---	--	--------

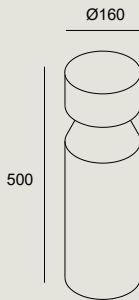

DC 



LED					
K	CRI	W LED	W Total	Real Lm	Code
3000	80	17.4	19.3	1071	55-E055 - DC - CL
 100-277V		50-60Hz			

nicht inklusive / Non incluso

Bodenbefestigungsbolzen 71-E029-48-48
Bulloni di fissaggio al suolo

IP 65	IK 10		SEA SIDE SUITABLE			BREEAM
----------	----------	---	----------------------	---	--	--------

DC 

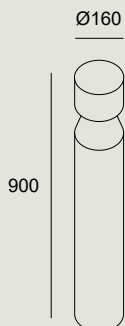

LED					
K	CRI	W LED	W Total	Real Lm	Code
3000	80	17.4	19.3	1071	55-E056 - DC - CL
 100-277V		50-60Hz			

nicht inklusive / Non incluso

Bodenbefestigungsbolzen 71-E029-48-48
Bulloni di fissaggio al suolo



Simenti

BODY MAT	DIF MAT		50000h	3
CON	GLA		L80 B20	MacAdam

Simenti ist eine Outdoor-Kollektion und verfügt über ein zeitloses Design aus Zement. Sie ist als Wandleuchte und Poller erhältlich und dient zur Beleuchtung von Außenwänden und Gärten. Als Bodenleuchte bietet sie eine allgemeine Beleuchtung und als Wandleuchte eine Up&Down-Beleuchtung.

Simenti è una collezione outdoor con un design che non scade mai, realizzata in cemento. Disponibile in formato da parete e come faretto, il prodotto viene progettato per illuminare facciate e giardini, offrendo un'illuminazione generale per l'opzione a pavimento e, Up&Down, per l'opzione a parete.



Anpassung an die Umgebung Mimetizzazione con l'ambiente

Zement ist ein in den meisten architektonischen und städtebaulichen Projekten häufig verwendetes Baumaterial. Diese Kollektion fügt sich vollkommen in die Umgebung ein und stellt das ausgestrahlte Licht in den Mittelpunkt.

Il cemento è un materiale da costruzione ricorrente nella maggior parte dei progetti di architettura ed urbanistica. Questa collezione permette mimetizzarsi con l'ambiente, cedendo tutto il protagonismo alla luce che proietta.



SIMENTI

Simenti Bollard

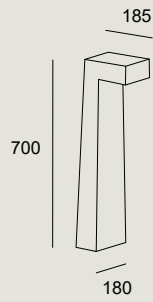

IP	IK	SEA SIDE		BREEAM
66	08	SUITABLE	ON-OFF	

DC

LED					
K	CRI	W LED	W Total	Real Lm	Code
3000	80	9	11.6	597	55-9971 - DC - CL
100-240V	50-60Hz				

nicht inklusive / Non incluso	
Bodenbefestigungsbolzen Bulloni di fissaggio al suolo	71-E030-48-48



Modis

LUCA TURRINI 2022

BODY MAT	DIF MAT		50000h	3
AL	GLA		L80 B20	MacAdam

Modis Opal Bollard

	IP 66	IK 10	LOW FLICKER	 350°	 90°		SEA SIDE SUITABLE	BREEAM	SWITCH CCT SW 2700-3200-4000	
--	----------	----------	----------------	----------	---------	--	----------------------	--------	---------------------------------	--

14* 34* 60* DL* E3* J6* Z5

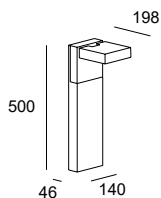

LED						
K	CRI	W LED	W Total	Real Lm	Code	
SW 2700-3200-4000	80	11.6	13.2	744	14	
					34	
					60	DU
					E3	OU
					J6	XB
					Z5	

XB Casambi
DU DALI-2
OU ON-OFF

	IP 66	IK 10	LOW FLICKER	 350°	 90°		SEA SIDE SUITABLE	BREEAM	SWITCH CCT SW 2700-3200-4000	
--	----------	----------	----------------	----------	---------	--	----------------------	--------	---------------------------------	--

14* 34* 60* DL* E3* J6* Z5

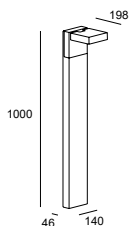

LED						
K	CRI	W LED	W Total	Real Lm	Code	
SW 2700-3200-4000	80	11.6	13.2	744	14	
					34	
					60	DU
					E3	OU
					J6	XB
					Z5	

XB Casambi
DU DALI-2
OU ON-OFF







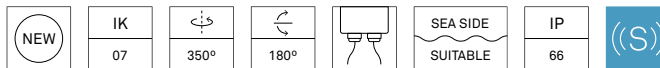

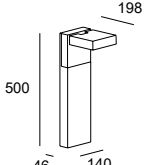

*Fragen Sie unser Verkaufsteam nach den Lieferbedingungen.

Consultare i termini e le condizioni di consegna al nostro team commerciale.

Modis Optics Bollard







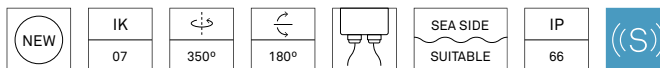



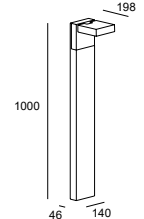

Codebeispiel / Esempio di codice: AS14-18V9S30UZ5

Model	W	K/ Cri/ Real lm	Optics	Source	Finishes
 	18 18,3W	V9 2700K CRI 90/1301 lm	S3 16°	OU  ON-OFF 100-277V 50-60Hz	Z5 
		W9 3000K CRI90/1301 lm	M3 33°	DS  DALI-2 220-240V 50-60Hz	14* 
		X9 4000K CRI90/1301 lm	F1 48°	XB  CASAMBI 220-240V 50-60Hz	60* 
					34* 
					J6* 
					E3* 
					DL* 



Codebeispiel / Esempio di codice: AS15-18V9S30UZ5

Model	W	K/ Cri/ Real lm	Optics	Source	Finishes
 	18 18,3W	V9 2700K CRI90/1301lm	S3 16°	OU  ON-OFF 100-277V 50-60Hz	Z5 
		W9 3000K CRI90/1301 lm	M3 33°	DS  DALI-2 220-240V 50-60Hz	14* 
		X9 4000K CRI90/1301 lm	F1 48°	XB  CASAMBI 220-240V 50-60Hz	60* 
					34* 
					J6* 
					E3* 
					DL* 

nicht mitgeliefertes
allgemeines Zub.
Access. comuni non inclusi

Blende weiß Visiera grigia	71-E234-14-00
Blende hellgrau Visiera grigio chiaro	71-E234-34-00
Blende schwarz Visiera nera	71-E234-60-00
Blende gold Visiera dorata	71-E234-DL-00
Blende tannengrün Visiera verde abete	71-E234-E3-00
Blende braun Visiera marrone	71-E234-J6-00
Blende grau Visiera grigia	71-E234-Z5-00
Befestigungsbolzen Perni di fissaggio	71-E363-48-48

*Fragen Sie unser Verkaufsteam nach den Lieferbedingungen.
Consultare i termini e le condizioni di consegna al nostro team commerciale.



Newton

Newton LED Pro

P. 713



250 mm



700 mm



1000 mm

28,2 W

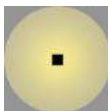

360°

Z5 ●

Newton LED

P. 714



250 mm



800 mm

12,7 W



360°

Z5 ●

Newton E27

P. 714



800 mm

max. 23 W



360°

Z5 ●



Newton



Newton ist eine Kollektion zeitlos gestalteter, runder Leuchtpfosten mit einer Lichtabstrahlung von 360°, die sich durch ihre große Robustheit auszeichnet. Sie ist in verschiedenen Höhen und in drei Ausführungen erhältlich: Newton LED Pro, Newton LED und Newton E27. Die Kollektion ist für die Ausleuchtung von Durchgangsbereichen und großen Räumen entwickelt, ohne dabei Abstriche beim visuellen Komfort zu machen. Alle Ausführungen sind mit doppelter Kabeleinführung für die mühelose Reiheninstallation ausgestattet und verfügen über eine Oberflächenbeschichtung, die sogar eine Aufstellung in Meeresnähe ermöglicht.

Newton è una collezione di faretti circolari dal design sempre attuale con una proiezione del fascio di luce a 360°, che si contraddistingue per la sua solidità. È disponibile in varie altezze e in 3 versioni: Newton LED Pro, Newton LED e Newton E27. Questa collezione è pensata per illuminare zone di passaggio e spazi ampi senza dover rinunciare al comfort visivo. Tutte le versioni sono dotate di doppio ingresso di cavo per agevolare l'installazione in serie e di un trattamento esterno che le rende adatte a essere installate vicino al mare.

Pro-Base-System Pro-base System



Newton verfügt über das Pro-Base-Befestigungssystem, das eine perfekte Installation und eine größere Stabilität und Haltbarkeit der Leuchte gewährleistet.

100 % integriert. Der Sockel ist vollständig in der Leuchte verborgen.

100% geschützt. Mit Technopolymerschicht, die den Sockel vor direktem Kontakt mit dem Boden isoliert und so ein Verkratzen des Aluminiums während der Installation verhindert.

100 % stabil. Der Sockel besteht aus besonders dickem Aluminium, um Schwachstellen zu vermeiden, und kann in privaten, öffentlich genutzten Bereichen wie Einkaufszentren oder Hotels installiert werden.

100 % zur Verwendung direkt am Meer geeignet. Die äußere Aluminiumschicht wird durch ein spezielles Verfahren verstärkt, das die Oxidation des Aluminiums verhindert.

100 % gerade. Mit drei zusätzlichen Löchern, die dafür sorgen, dass alle Bodenaufbauleuchten während der Installation absolut gerade sind, ohne jegliche Neigung.

Newton dispone del sistema di fissaggio Pro-base System, che garantisce una perfetta installazione, insieme a una maggiore stabilità e durata dell'apparecchio.

Integrato al 100%. Base totalmente nascosta all'interno del faretto.

Protetto al 100%. È inclusa una piastra in tecnopolimero per isolare la base dal contatto diretto con il suolo, evitando così eventuali graffi sull'alluminio durante l'installazione.

Stabile al 100%. Base realizzata in alluminio, di maggior spessore, per evitare punti deboli; si può installare in aree private di uso pubblico come centri commerciali o hotel.

Adatto al 100% per il lungomare. Processo speciale per rinforzare lo strato esterno di alluminio, prevenendone l'ossidazione.

Dritto al 100%. Sono inclusi 3 fori extra per far sì che i faretti restino assolutamente dritti durante l'installazione, senza alcuna inclinazione.



NEWTON LED PRO



Die Newton LED Pro-Reihe ist die leistungsstärkste der Kollektion und hat den größten Durchmesser. Sie ist als einzige serienmäßig mit dem DALI-Dimmsystem ausgestattet und erfüllt die Anforderungen des BREEAM-Effizienzstandards. Dank der hohen Leuchtdichte kann sie für die Beleuchtung von Wegen und Gehwegen bis hin zu größeren Flächen eingesetzt werden. La gamma Newton LED Pro è la più potente della collezione e quella con il diametro maggiore. È l'unica a disporre di un sistema di regolazione DALI di serie e a rispettare la normativa di efficienza richiesta dalla BREEAM. Può essere impiegata per illuminare camminatoi e percorsi ma anche zone più grandi, grazie al buon livello di luminosità che offre.

Verschiedene Größen Varie misure

Sie ist in drei Bauhöhen erhältlich: 25 cm, 70 cm und 100 cm.
È disponibile in tre altezze: 25cm, 70cm e 100cm.

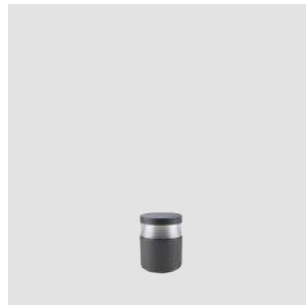

Smart-Funktion: Zeitliche Programmierung Funzionalità Smart: Programmazioni orarie

Der Leuchtpfosten Newton LED Pro kann mit dem entsprechenden Smart-Zubehör über die Casambi-APP ferngesteuert werden und Funktionen wie das Ein- und Ausschaltprogramm nach einem festgelegten Zeitplan ausführen. Dies ist in Durchgangsbereichen, in denen die Leuchte normalerweise aufgestellt wird, unerlässlich.

Il faretto Newton LED Pro, con il relativo accessorio Smart, può essere gestito da remoto tramite la APP di Casambi e svolgere funzioni come la programmazione di accensione e spegnimento in base a un orario prestabilito, indispensabile in zone di passaggio dove normalmente questa luce viene collocata.



NEWTON LED



Newton LED wurde für Projekte mit LED-Lichtquellen entwickelt, die keine Dimmung oder hohe Leuchtkraft erfordern, jedoch die Robustheit und Zuverlässigkeit der Kollektion nutzen möchten. Sie ist in zwei Bauhöhen erhältlich.

Newton LED è pensata per progetti con sorgenti luminose LED che non richiedono regolazione né un grande flusso in uscita, ma che non vogliono rinunciare alla grande robustezza e all'affidabilità di questa collezione. È disponibile in due altezze.

NEWTON E27



Newton E27 wurde für Projekte entwickelt, die ein austauschbares Leuchtmittel erfordern und gleichzeitig die Robustheit und Zuverlässigkeit der Kollektion nutzen möchten. Sie ist in einer Bauhöhe erhältlich.

Newton E27 è pensata per progetti che necessitano di una sorgente luminosa intercambiabile senza dover rinunciare alla grande robustezza e affidabilità di questa collezione. Disponibile in una sola altezza.

NEWTON

Newton LED Pro

NEW	DIF MAT PC	IP 66	IK 10	LOW FLICKER		50000h L80 B20	3 MacAdam		
BREEAM	SEA SIDE SUITABLE								

Z5 ●



LED					
K	CRI	W LED	W TOTAL	Real Lm	Code
3000	80	22.8	25.1	2450	10-E016 - Z5 - CL
220-240V		50-60Hz			

NEW	DIF MAT PC	IP 66	IK 10	LOW FLICKER		50000h L80 B20	3 MacAdam		
BREEAM	SEA SIDE SUITABLE								

Z5 ●

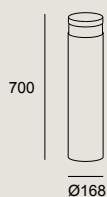

LED					
K	CRI	W LED	W TOTAL	Real Lm	Code
3000	80	22.8	25.1	2450	55-E016 - Z5 - CL
220-240V		50-60Hz			

DIF MAT PC	IP 66	IK 10	LOW FLICKER		50000h L80 B20	3 MacAdam			BREEAM
SEA SIDE SUITABLE									

Z5 ●

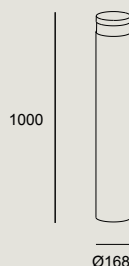

LED					
K	CRI	W LED	W TOTAL	Real Lm	Code
3000	80	22.8	25.1	2450	55-E054 - Z5 - CL
220-240V		50-60Hz			

nicht mitgeliefertes
allgemeines Zub.
Access. comuni non inclusi

Bodenbefestigungsbolzen
Bulloni di fissaggio al suolo

71-E006-48-48

Smart Compatible-Zub.
Access. Smart Compatibile

Converter Casambi DALI IP66

71-A237-00-00

OUTDOOR POLLERLEUCHTEN / FARETTI

NEWTON

Newton LED

DIF MAT	50000h	3	IP	IK		SEA SIDE		
PC	L80 B20	MacAdam	65	08		SUITABLE		

Z5 ●

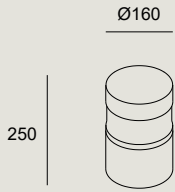

LED					
K	CRI	W LED	W Total	Real Lm	Code
3000	80	12.7	13.9	573	10-9791 - Z5 - CL
		100-240V 50-60Hz			

DIF MAT	50000h	3	IP	IK		SEA SIDE		
PC	L80 B20	MacAdam	65	08		SUITABLE		

Z5 ●

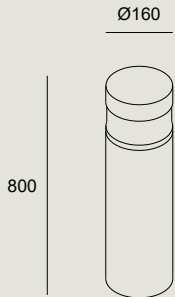

LED					
K	CRI	W LED	W Total	Real Lm	Code
3000	80	12.7	13.9	573	55-9791 - Z5 - CL
		100-240V 50-60Hz			

nicht inklusive / Non incluso

Bodenbefestigungsbolzen
Bulloni di fissaggio al suolo

71-E013-48-48

NEWTON

Newton E27

DIF MAT	IP	IK		SEA SIDE	
PC, GLA	65	08		SUITABLE	

Z5 ●

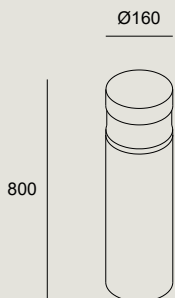

E27	
W	Code
max. 23	55-9504 - Z5 - M2

nicht inklusive / Non incluso

Bodenbefestigungsbolzen
Bulloni di fissaggio al suolo

71-E013-48-48

Cilin

BODY MAT	DIF MAT		50000h	3
AL	PC		L80 B20	MacAdam



IP	IK	SEA SIDE		
66	09	SUITABLE	PRO-BASE	ON-OFF

Z5 ●

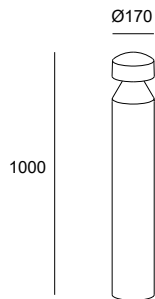

LED					
K	CRI	W LED	W Total	Real Lm	Code
3000	80	23	26.8	774	55-9890 - Z5 - CL
4000	80	23	26.8	851	55-9890 - Z5 - CM
100-240V		50-60Hz			

nicht inklusive / Non incluso

Bodenbefestigungsbolzen
Bulloni di fissaggio al suolo

71-E006-48-48



Dan

BODY MAT	DIF MAT		50000h	3
AL	PC		L80 B20	MacAdam



Verschiedene Abmessungen und Ausführungen

Varie misure e finiture

Dan ist eine Leuchtpfosten-Kollektion, die sich durch ihrer große Vielseitigkeit ideal für die Beleuchtung von Flächen, Wegen und Durchgangsbereichen in Wohngebäuden eignet. Die als Zubehör im Lieferumfang enthaltene Lichtblende ermöglicht die Umschaltung von der 360°-Beleuchtung zu einem konzentrierten 180°-Leuchtstrahl. Die Leuchte verfügt über einen eingebauten Schalter zur Änderung der Farbtemperatur und wird mit dem Pro-Base-System am Boden befestigt, um die größtmögliche Stabilität der Leuchte zu gewährleisten.

Dan è una collezione di faretti che, grazie alla sua grande versatilità, è perfetto per illuminare aree, percorsi e zone di passaggio di spazi residenziali. L'accessorio otturatore di luce incluso consente di passare da un'illuminazione a 360° a una concentrazione del fascio luminoso a 180°. È provvisto di un interruttore incorporato per cambiare la temperatura del colore e di un sistema di fissaggio al suolo Pro-base System che garantisce una maggiore stabilità dell'apparecchio.

Die Kollektion ist in zwei Höhen (45 cm und 70 cm) und zwei Ausführungen erhältlich: Stadtgrau, ideal für moderne oder gepflasterte Zonen, und Braun für begrünte und naturbelassene Zonen.

Questa collezione è disponibile in 2 altezze (45 cm e 70 cm) e in 2 finiture, grigio urbano, perfetto per ambienti moderni o pavimentati e marrone per giardini e ambienti naturali circondati da vegetazione.

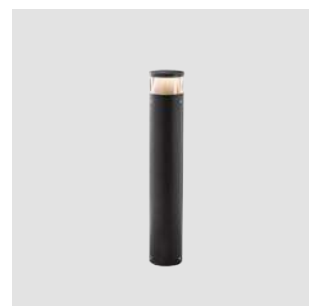

CCT-Technologie Tecnologia CCT

Die Kollektion ist mit der CCT-Technologie ausgestattet, bei der Sie die Farbtemperatur (3000K oder 4000K) über einen Schalter wählen können. Die Farbtemperatur kann mit dem eingebauten Schalter geändert werden, der damit bereits in der Artikelbestellung enthalten ist.

La collezione include la tecnologia CCT, con la quale è possibile scegliere la temperatura del colore, tramite un interruttore (3000K e 4000K). Lo switch integrato permette la variazione della temperatura di colore, partendo da un unico codice di riferimento.



4000K



3000K

Pro-Base-System Pro-base System



Dan verfügt über das Pro-Base-Befestigungssystem, das eine perfekte Installation und eine größere Stabilität und Haltbarkeit der Leuchte gewährleistet.

100 % integriert. Der Sockel ist vollständig in der Leuchte verborgen.

100% geschützt. Mit Technopolymerschicht, die den Sockel vor direktem Kontakt mit dem Boden isoliert und so ein Verkratzen des Aluminiums während der Installation verhindert.

100 % stabil. Der Sockel besteht aus besonders dickem Aluminium, um Schwachstellen zu vermeiden, und kann in privaten, öffentlich genutzten Bereichen wie Einkaufszentren oder Hotels installiert werden.

100 % zur Verwendung direkt am Meer geeignet. Die äußere Aluminiumschicht wird durch ein spezielles Verfahren verstärkt, das die Oxidation des Aluminiums verhindert.

100 % gerade. Mit drei zusätzlichen Löchern, die dafür sorgen, dass alle Bodenaufbauleuchten während der Installation absolut gerade sind, ohne jegliche Neigung.

Dan dispone del sistema di fissaggio Pro-base system, che garantisce una perfetta installazione, insieme a una maggiore stabilità e durata dell'apparecchio.

Integrato al 100%. Base completamente nascosta all'interno del faretto.

Protetto al 100%. È inclusa una piastra in tecnopolimero per isolare la base dal contatto diretto con il suolo, evitando così eventuali graffi sull'alluminio durante l'installazione.

Stabile al 100%. Base realizzata in alluminio, di maggior spessore, per evitare punti deboli; si può installare in aree private di uso pubblico come centri commerciali o hotel.

Adatto al 100% per il lungomare. Processo speciale per rinforzare lo strato esterno di alluminio, prevenendone l'ossidazione.

Dritto al 100%. Sono inclusi 3 fori extra per far sì che i faretti restino assolutamente dritti durante l'installazione, senza alcuna inclinazione.

Höchste Langlebigkeit und Widerstandsfähigkeit
Massima durabilità e resistenza.

Mit einem Gehäuse aus Aluminium mit Antioxidations-Behandlung und einem PC-Diffusor, die die Lebensdauer des Produkts maximieren und seine Installation in nassen Umgebungen oder sogar direkt am Meer ermöglichen.

Dotato di un corpo in alluminio con trattamento antiruggine, prima della verniciatura, e di un diffusore in PC per massimizzare la vita utile del prodotto, permettendo la sua installazione in ambienti umidi o anche sul lungomare.



Zubehör
Accessorio

Mit Lichtblende, die einen einzigen, nach vorne gerichteten Lichtstrahl anstelle von 360°-Beleuchtung ermöglicht.

Include un otturatore della luce che consente di ottenere un fascio di luce solo di fronte invece che a 360°.

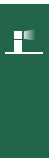
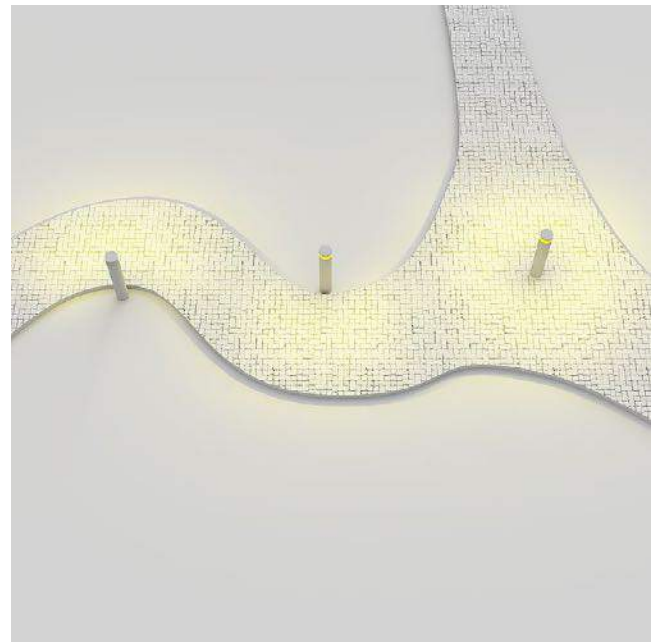

DAN

NEW	IP 66	IK 10	SEA SIDE SUITABLE	PRO-BASE	ON-OFF	SWITCH CCT SW 3000-4000
-----	----------	----------	----------------------	----------	--------	----------------------------

J6 ● Z5 ●

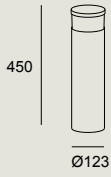

LED						
K	CRI	W LED	W Total	Real Lm	Code	
SW 3000-4000	80	8.9	11.2	439	55-E019 - J6 - Z5 - EH	
100-240V		50-60Hz				

IP 66	IK 10	SEA SIDE SUITABLE	PRO-BASE	ON-OFF	SWITCH CCT SW 3000-4000
----------	----------	----------------------	----------	--------	----------------------------

J6 ● Z5 ●

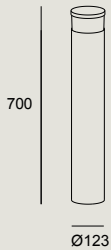

LED						
K	CRI	W LED	W Total	Real Lm	Code	
SW 3000-4000	80	8.9	11.2	439	55-E012 - J6 - Z5 - EH	
100-240V		50-60Hz				

mitgeliefertes allgemeines Zub.
Access. comuni inclusi

Lichtblende hinten
Otturatore della luce posteriore

**nicht mitgeliefertes
allgemeines Zub.**
Access. comuni non inclusi

Befestigungsbolzen
Perni di fissaggio

71-E092-48-48

Lyon

BODY MAT	DIF MAT		50000h	3
AL	PC		L80 B20	MacAdam



IP	IK	SEA SIDE			BREEAM
66	10	SUITABLE	PRO-BASE	ON-OFF	

Z5 ●

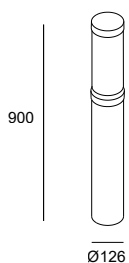

LED					
K	CRI	W LED	W Total	Real Lm	Code
3000	80	23	26	2146	55-E092 - Z5 - CL
100-240V		50-60Hz			

nicht inklusive / Non incluso	
Befestigungsbolzen Perni di fissaggio	71-E092-48-48



Cubik

BODY MAT
AL

DIF MAT
PC



Verschiedene Formate Diversi formati

Diese Produktreihe aus zeitlosen und neutralen Design-Leuchten wurde entwickelt, um eine Allgemeinbeleuchtung für professionelle Projekte und die private Anwendung zu schaffen. Die Leuchte besteht aus Aluminium und Polycarbonat und verfügt damit über eine hohe Widerstandsfähigkeit und die Möglichkeit, diese auch unter widrigen Wetterbedingungen installieren zu können.

Questa collezione di faretti con un design neutro e duraturo nel tempo è progettata per creare una luce generale in progetti sia professionali che domestici. Realizzato in alluminio e in polycarbonato, il pezzo acquista una grande robustezza, rendendo possibile la sua installazione in ambienti con condizioni meteorologiche avverse.

Die Kollektion verfügt über drei unterschiedliche Formate. An der Wand, sowie als Pfosten mit 65 cm und 1 m Höhe.

La collezione di faretti è presentata in 3 formati con diverse altezze: a parete, un faretto da 65 cm e un faretto da 1 m.



CUBIK

Cubik LED

50000h	3	IP	IK		BREEAM
L80 B20	MacAdam	65	10	PRO-BASE	

Z5 ●

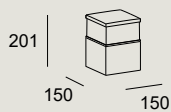

LED					
K	CRI	W LED	W Total	Real Lm	Code
3000	80	15	16.2	833	10-9938 - Z5 - CL
100-240V		50-60Hz			

50000h	3	IP	IK		BREEAM
L80 B20	MacAdam	65	10	PRO-BASE	

Z5 ●

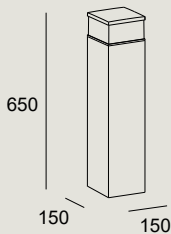

LED					
K	CRI	W LED	W Total	Real Lm	Code
3000	80	15	16.2	833	55-9938 - Z5 - CL
100-240V		50-60Hz			

50000h	3	IP	IK		BREEAM
L80 B20	MacAdam	65	10	PRO-BASE	

Z5 ●

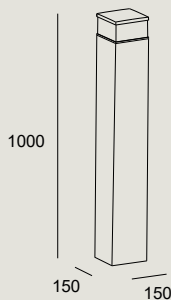

LED					
K	CRI	W LED	W Total	Real Lm	Code
3000	80	15	16.2	833	55-9939 - Z5 - CL
100-240V		50-60Hz			

nicht mitgeliefertes
allgemeines Zub.
Access. comuni non inclusi

Bodenbefestigungsschrauben
Bulloni di fissaggio a pavimento

71-E164-48-48

Cubik E27

BODY MAT
AL

DIF MAT
PC



IP
54

IK
10

SEA SIDE
SUITABLE

Z5 ●

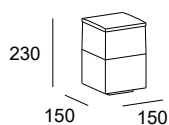

E27	
W max. 60	Code 10-9386 - Z5 - M3



IP
54

IK
10

SEA SIDE
SUITABLE

Z5 ●

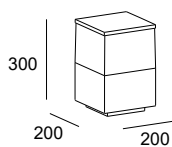

E27	
W max. 100	Code 10-9387 - Z5 - M3

Cubik E27

BODY MAT
AL

DIF MAT
PC



IP
54

IK
10

SEASIDE
SUITABLE

Z5 ●

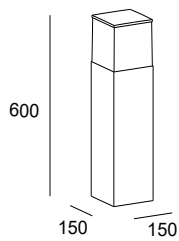

E27	
W	Code
max. 60	55-9488 - Z5 - M3

nicht inklusive / Non incluso	
Bodenbefestigungsbolzen Bulloni di fissaggio al suolo	71-E002-48-48



IP
54

IK
10

SEASIDE
SUITABLE

Z5 ●

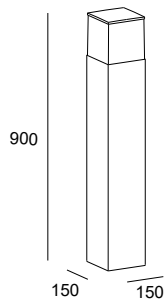

E27	
W	Code
max. 60	55-9549 - Z5 - M3

nicht inklusive / Non incluso	
Bodenbefestigungsbolzen Bulloni di fissaggio al suolo	71-E002-48-48



Nott LED

BODY MAT	DIF MAT	
PP	PC	



IP	IK	50000h	3	SEA SIDE	
65	08	L80 B20	MacAdam	SUITABLE	ON-OFF

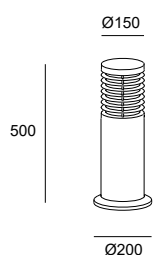

05 ●

LED					
K	CRI	W LED	W Total	Real Lm	Code
3000	80	16.5	18.6	516	55-E017 - 05 - CL
					
100-240V		50-60Hz			



IP	IK	50000h	3	SEA SIDE	
65	08	L80 B20	MacAdam	SUITABLE	ON-OFF

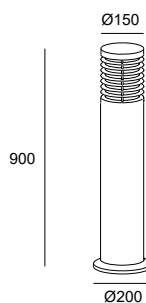

05 ●

LED					
K	CRI	W LED	W Total	Real Lm	Code
3000	80	16.5	18.6	516	55-E018 - 05 - CL
					
100-240V		50-60Hz			

nicht mitgeliefert
allgemeines Zub.
Access. comuni non inclusi

Bodenbefestigungsbolzen
Bulloni di fissaggio al suolo

71-E018-48-48

Nott E27

BODY MAT	DIF MAT	
PP	PC	



IP	IK	SEASIDE
65	08	SUITABLE

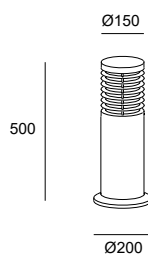

05 ●

E27	
W max. 23	Code 55-9655 - 05 - CD



IP	IK	SEASIDE
65	08	SUITABLE

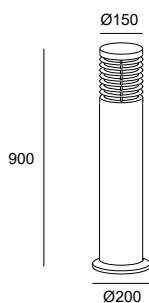

05 ●

E27	
W mac. 23	Code 55-9656 - 05 - CD

nicht mitgeliefertes
allgemeines Zub.
Access. comuni non inclusi

Bodenbefestigungsbolzen
Bulloni di fissaggio al suolo

71-E018-48-48



Balizas

BODY MAT	DIF MAT	
AL	PC	

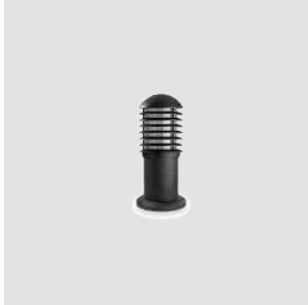

IP	IK	SEA SIDE
44	08	SUITABLE

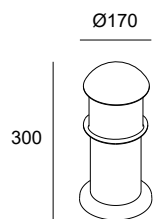

Z5 ●

E27	
W max. 100	Code 55-9318 - Z5 - M3

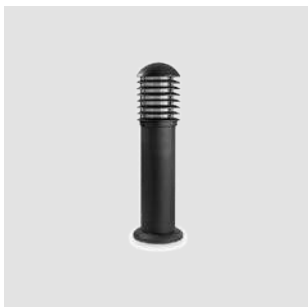

IP	IK	SEA SIDE
44	08	SUITABLE

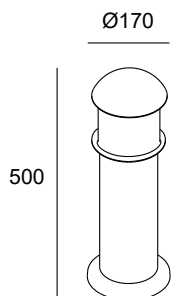

Z5 ●

E27	
W max. 100	Code 55-9319 - Z5 - M3

Balizas

BODY MAT
AL

DIF MAT
PC

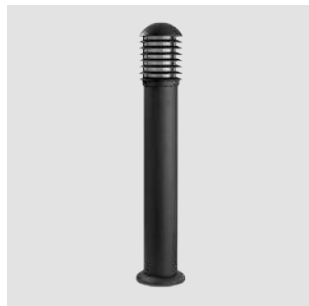

IP
44

IK
08

SEASIDE
SUITABLE

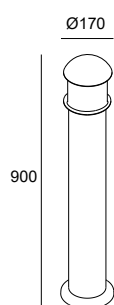

Z5 ●

E27	
W max. 100	Code 55-9320 - Z5 - M3

nicht mitgeliefertes
allgemeines Zub.
Access. comuni non inclusi

Bodenbefestigungsbolzen
Bulloni di fissaggio al suolo

71-9955-48-48

Diago

BODY MAT	DIF MAT		50000h	3
AL	GLA		L80 B20	MacAdam



IP	IK	SEA SIDE		BREEAM
65	05	SUITABLE	ON-OFF	

Z5 ●

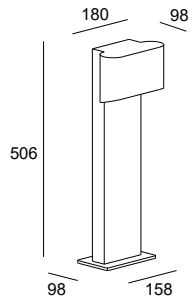

LED					
K	CRI	W LED	W Total	Real Lm	Code
3000	80	4.8	6.5	494	55-9873 - Z5 - CL
100-240V		50-60Hz			

nicht inklusive / Non incluso	
Bodenbefestigungsbolzen Bulloni di fissaggio al suolo	71-E009-48-48

Priap

BODY MAT
AISI316

DIF MAT
PC



IP
54

IK
07

SEA SIDE
SUITABLE

PRO-BASE

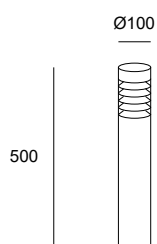

CA ●

E27				
<table border="0"> <tr> <td style="text-align: center;">W</td> <td style="text-align: right;">Code</td> </tr> <tr> <td style="text-align: center;">max. 23</td> <td style="text-align: right;">55-9239 - CA - M2</td> </tr> </table>	W	Code	max. 23	55-9239 - CA - M2
W	Code			
max. 23	55-9239 - CA - M2			



IP
54

IK
07

SEA SIDE
SUITABLE

PRO-BASE

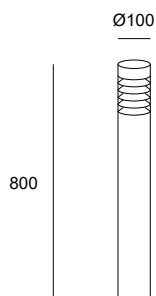

CA ●

E27				
<table border="0"> <tr> <td style="text-align: center;">W</td> <td style="text-align: right;">Code</td> </tr> <tr> <td style="text-align: center;">max. 23</td> <td style="text-align: right;">55-9440 - CA - M2</td> </tr> </table>	W	Code	max. 23	55-9440 - CA - M2
W	Code			
max. 23	55-9440 - CA - M2			

nicht mitgeliefertes
allgemeines Zub.
Access. comuni non inclusi

Bodenbefestigungsbolzen
Bulloni di fissaggio al suolo

71-E028-48-48

OUTDOOR POLLERLEUCHTEN / FARETTI

Helion

BODY MAT	DIF MAT		50000h	3
AL	PC		L80 B20	MacAdam



IP	IK	SEA SIDE	
54	08	SUITABLE	ON-OFF

Z5 ●

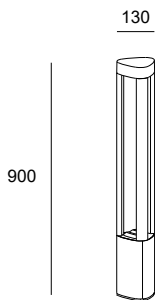

LED					
K	CRI	W LED	W Total	Real Lm	Code
3000	80	9	11.4	399	55-9721 - Z5 - M1
100-240V		50-60Hz			

nicht inklusive / Non incluso

Bodenbefestigungsbolzen
Bulloni di fissaggio al suolo

71-E012-48-48

Cubus

BODY MAT	DIF MAT		50000h	3
AL	GLA		L80 B20	MacAdam



IP	IK		SEA SIDE	
65	10	±45°	SUITABLE	ON-OFF

Z5 ●

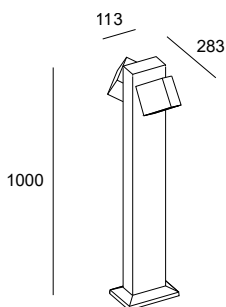

LED					
K	CRI	W LED	W Total	Real Lm	Code
3000	80	22	24.9	1031	55-9944 - Z5 - CL
100-240V		50-60Hz			

nicht inklusive / Non incluso

Bodenbefestigungsbolzen
Bulloni di fissaggio al suolo

71-E008-48-48

Way

BODY MAT
AL

DIF MAT
GLA



IP	IK	
66	08	±45°

Z5 ●

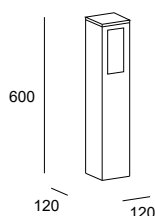

GU10				
<table border="0"> <tr> <td style="text-align: center;">W</td> <td style="text-align: center;">Code</td> </tr> <tr> <td style="text-align: center;">max. 50</td> <td style="text-align: center;">55-9682 - Z5 - 37</td> </tr> </table>	W	Code	max. 50	55-9682 - Z5 - 37
W	Code			
max. 50	55-9682 - Z5 - 37			



IP	IK	
66	08	±45°

Z5 ●

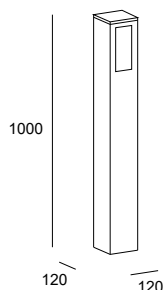

GU10				
<table border="0"> <tr> <td style="text-align: center;">W</td> <td style="text-align: center;">Code</td> </tr> <tr> <td style="text-align: center;">max. 50</td> <td style="text-align: center;">55-9921 - Z5 - 37</td> </tr> </table>	W	Code	max. 50	55-9921 - Z5 - 37
W	Code			
max. 50	55-9921 - Z5 - 37			

nicht mitgeliefertes
allgemeines Zub.
Access. comuni non inclusi

Bodenbefestigungsbolzen
Bulloni di fissaggio al suolo

71-E031-48-48

Invisible

FRANCESC VILARÓ 2018

DIF MAT		50000h	3
PC		L80 B20	MacAdam



Schwenkbarer Leuchtkopf Testa inclinabile

Eine Leuchtenkollektion mit minimalistischem Design, leichtem zylinderförmig-länglichem Gehäuse und rundem, um 355° kippbarem Leuchtkopf. In verschiedenen Höhen und in schwarzer Oberfläche lieferbar. Das schwarze Gehäuse lässt die Leuchte fast unsichtbar werden und betont den Lichtstrahl.

Si tratta di una collezione di apparecchi con un design minimalista, composta da una struttura cilindrica, leggera ed allungata e da una testa tonda inclinabile di 355°. È disponibile in diverse altezze e con finitura nera, cosa che enfatizza il carattere invisibile dell'apparecchio e dà importanza alla luce.

Dank des um 355° schwenkbaren Kopfes passt sich Invisible an die Bedürfnisse jedes Projekts an.

Grazie alla caratteristica inclinabile della testa, con una rotazione di 355°, Invisible può essere adattato alle esigenze di qualsiasi progetto.

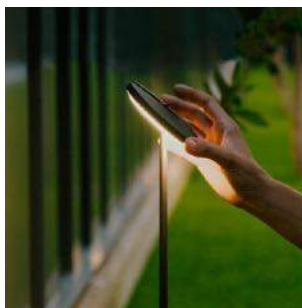

Totale Vielseitigkeit Versatilità totale

In zwei Formaten erhältlich: mit Befestigung durch einen Erdspieß für Rasenflächen oder andere weiche Materialien, und mit Befestigung durch Schrauben für Böden aus Zement, Terrazzo oder anderen Materialien, bei denen der Erdspieß nicht verwendet werden kann.

È disponibile in due formati: con fissaggio, tramite picchetto per pavimenti in erba o altri materiali morbidi, e, con fissaggio, tramite viti, per pavimenti in cemento, terrazzo o altri materiali dove il picchetto non può essere utilizzato.



INVISIBLE

BODY MAT	IP	IK		SEA SIDE	
AL / GL	54	04	355°	SUITABLE	ON-OFF

05 ●

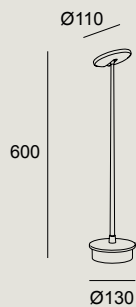

LED					
K	CRI	W LED	W Total	Real Lm	Code
3000	80	9	10.7	469	55-9733 - 05 - M1
100-240V		50-60Hz			

BODY MAT	IP	IK		SEA SIDE	
AL / GL	54	04	355°	SUITABLE	ON-OFF

05 ●

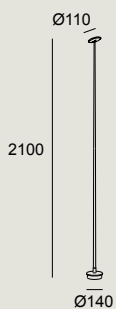

LED					
K	CRI	W LED	W Total	Real Lm	Code
3000	80	9	10.7	469	25-9733 - 05 - M1
100-240V		50-60Hz			

BODY MAT	IP	IK		SEA SIDE		
AL	54	04	355°	SUITABLE	ON-OFF	1.5 m

05 ●

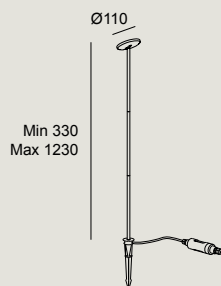

LED					
K	CRI	W LED	W Total	Real Lm	Code
3000	80	9	10.7	469	10-9733 - 05 - CL
100-240V		50-60Hz			

inklusive / Incluso

IP67 Driver & Connector
IP67 Driver & Connector

Erdspeiß
Picchetto





Juncus

LUCA TURRINI 2018

BODY MAT	DIF MAT		50000h	2
AL	PC		L80 B20	MacAdam



Anpassung an die Umgebung Adattabilità all'ambiente

Mit seinem minimalistischen Design, dem braunem Finish und der flexiblen Befestigungshöhe ermöglicht diese Pollerleuchte eine natürliche Einbindung und Anpassung an die Landschaft. Durch das Zoom-Linsensystem im Inneren des zylindrischen Gehäuses der Leuchte wird maximaler visueller Komfort möglich.

Con un design minimalista, una finitura marrone ed una versatilità nell'altezza dell'installazione, questo faretto risponde al desiderio di fondersi con l'ambiente e di integrarsi perfettamente nel paesaggio. Il suo sistema di lenti zoom, nascosto all'interno del corpo cilindrico dell'apparecchio, consente un maggiore comfort visivo.

Mit seinem um $\pm 90^\circ$ verstellbaren Leuchtkörper und der Möglichkeit, je nach den Anforderungen des Projekts vier verschiedene Höhen zu verwenden, passt sich Juncus zu 100 % seiner Umgebung an. Mit Erdspeer zur einfachen Bodenbefestigung.

Juncus si adatta al 100% all'ambiente grazie al suo corpo regolabile di $\pm 90^\circ$ ed alla possibilità di giocare con 4 diverse altezze, a seconda delle esigenze del progetto. Include un picchetto per un facile fissaggio sul terreno.



Hohe Widerstandsfähigkeit Grande resistenza

Das hochwertige Material ermöglicht eine Installation in Meeresnähe und gewährleistet eine maximale Widerstandsfähigkeit gegen mechanische Einwirkungen.

La qualità del materiale garantisce la fattibilità dell'installazione in prossimità del mare, così come la massima resistenza all'impatto meccanico.

JUNCUS

Juncus Bollard

IP	IK	LOW			SEA SIDE		BREEAM
65	10	FLICKER	360°	1.5 m	SUITABLE	ON-OFF	

J6

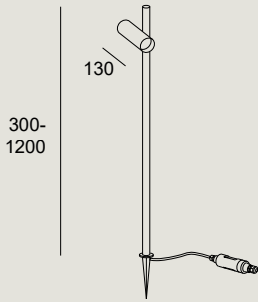

LED					
K	CRI	W LED	W Total	Real Lm	Code
3000	80	6.4	8.3	418	10-E013 - J6 - CL
	100-240V	50-60Hz			

inklusive / Incluso
IP67 Driver & Connector IP67 Driver & Connector
Erdspieß Picchetto



Mastleuchten

Lampioni



Modis

742



Juncus

744



Zigzag

747



Citizen

752



Lyon

753

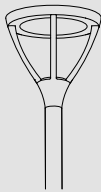

Proud

754

Modis

LUCA TURRINI 2022

BODY MAT	DIF MAT	50000h	3
AL	GLA	L80 B20	MacAdam



Modis ist ein neuer Vorschlag für den Außenbereich mit einer ausgeprägt dekorativen Komponente. Ein klares und neutrales Profil sowie eine Konstruktion, die eine hohe Beweglichkeit des Kugelgelenks erlaubt und die Möglichkeit bietet, die Abstrahlungsart zu wählen, denn die Leuchte ist wahlweise mit konzentriertem oder gebündeltem Licht erhältlich. Die vielköpfige Familie der Kollektion und ihre Kompositionsmöglichkeiten machen sie zu einer Lösung, die sich durch ihre Vielseitigkeit auszeichnet und sich meisterhaft und elegant an die Anforderungen von Projekten anpasst, die ein ästhetisches Gleichgewicht im Gesamtbild erfordern. Neben den dekorativen Vorzügen wurde auch den technischen Aspekten große Aufmerksamkeit gewidmet, um die Vielseitigkeit der Familie noch stärker zu betonen. Modis weist eine hohe Stoßfestigkeit (IK10), Staubdichtheit und Hochdruckwasserbeständigkeit (IP66) auf und kann dank der KTL-Grundierung auch in Umgebungen mit harter Seeluft aufgestellt werden.

Modis è una nuova proposta da esterno con una grande componente decorativa. Dal profilo pulito e neutro, il suo design si basa sulla grande capacità di movimento dello snodo e sulla possibilità di scegliere il fascio di luce, con opzione luce concentrata o diffusa. La grande famiglia della collezione e le sue possibilità compositive la trasformano in una scelta caratterizzata da versatilità e adattabile con maestria ed eleganza alle esigenze di progetti che richiedono insieme esteticamente equilibrati. Oltre al valore decorativo, gli aspetti tecnici sono stati curati fin nei minimi dettagli, per offrire una linea ancora più polivalente. Modis ha una grandissima resistenza agli urti (IK10), un'eccellente protezione dall'ingresso di polvere e acqua ad alta pressione (IP66) e può essere installata in ambienti con atmosfera marina, grazie al processo di verniciatura in catforesi.



MODIS

Modis Opal Lampost

NEW	IP 66	IK 10	LOW FLICKER	350°	90°	SEA SIDE SUITABLE	BREEAM	SWITCH CCT SW 2700-3200-4000	(S)
-----	----------	----------	----------------	------	-----	----------------------	--------	---------------------------------	-----

14* 34* 60* DL* E3* J6* Z5

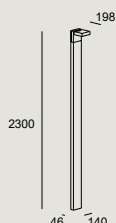

LED						
K	CRI	W LED	W Total	Real Lm	Code	
SW 2700-3200-4000	80	11.6	13.2	744	55-E024 -	DL - DU E3 - OU J6 Z5

XB Casambi
DU DALI-2
OU ON-OFF

MODIS

Modis Optics Lampost

NEW	IK 07	350°	180°	SEA SIDE SUITABLE	IP 66	(S)
-----	----------	------	------	----------------------	----------	-----

Codebeispiel / Esempio di codice: AS16-18V9S30UZ5

Model	W	K/ Cri/ Real lm	Optics	Source	Finishes
 AS16 - 180°	18 18,3W	V9 2700K CRI90/1301 lm	S3 16°	OU ON-OFF 100-277V 50-60Hz	Z5
		W9 3000K CRI90/1301 lm	M3 33°	DS DALI-2 220-240V 50-60Hz	14*
		X9 4000K CRI90/1301 lm	F1 48°	XB CASAMBI 220-240V 50-60Hz	60*
					34*
					J6*
					E3*
					DL*

mitgeliefertes allgemeines Zub. Befestigungssystem zum Erdeinbau
 Access. comuni inclusi Sistema di fissaggio per interrimento nel suolo

nicht mitgeliefertes allgemeines Zub. Access. comuni non inclusi		
Blende weiß Visiera bianca		71-E234-14-00
Blende hellgrau Visiera grigio chiaro		71-E234-34-00
Blende schwarz Visiera nera		71-E234-60-00
Blende gold Visiera dorata		71-E234-DL-00
Blende tannengrün Visiera verde abete		71-E234-E3-00
Blende braun Visiera marrone		71-E234-J6-00
Blende grau Visiera grigia		71-E234-Z5-00

*Fragen Sie unser Verkaufsteam nach den Lieferbedingungen.
 Consultare i termini e le condizioni di consegna al nostro team commerciale.

Juncus

LUCA TURRINI 2020

BODY MAT

DIF MAT



50000h

2

AL

GLA

L80 B20

MacAdam



Mit der Mastleuchte Juncus wollten wir große Außenbereiche beleuchten, ohne auf die Einzigartigkeit der Juncus-Reihe zu verzichten.

Il lampione Juncus pretende illuminare ampi spazi esterni e mantenere l'essenza della collezione Juncus.



Individuelle Ausrichtung Regolazione indipendente

Sie verfügt über ein minimalistisches Design und ein braunes Finish. Die LED-Schwenkköpfe können individuell ausgerichtet werden und fügen sich vollständig in die Umgebung ein. Wie in den übrigen Versionen kann auch hier die Öffnung des Lichtkegels durch das Zoom-Linsensystem im Inneren des zylindrischen Gehäuses der Leuchte eingestellt werden.

Il suo design minimalista, la sua finitura marrone e la possibilità di regolare le teste dei LED in modo indipendente, permettono di facilitare la sua completa integrazione nell'ambiente. In tutte le sue versioni, permette anche di adattare l'apertura del fascio luminoso attraverso il sistema di lenti zoom che è nascosto all'interno delle teste degli apparecchi.

Stabile Befestigung Ancoraggio perfetto

Mit speziellem Befestigungssystem, das die Stabilität der Leuchte gewährleistet.

Dispone di uno speciale sistema di fissaggio per garantire la stabilità dell'apparecchio.



JUNCUS

IP 66	IK 05	 ±90°			SEA SIDE SUITABLE	 DALI	BREEAM
----------	----------	---	---	---	----------------------	---	--------

J6 

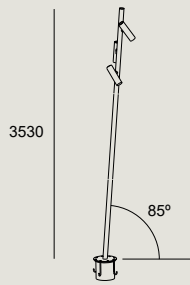

LED						
K	CRI	W LED	W Total	Real Lm	Optics	Code
3000	80	36.1	41	3712	Flood 45°	60-E057 - J6 - CL
 100-277V		50-60Hz				

inklusive / Incluso

Bolzen und Schablone
Bulloni e cornice di fissaggio





Zigzag

LUCA TURRINI 2020

BODY MAT

AL



Symmetrische Option Opzione simmetrica

Mastleuchte in modernem Design mit Zickzack-Form für optimale Integration mit der Architektur, ideal für öffentlich genutzte oder private Bereiche wie Einkaufszentren, Hotels und Wohnsiedlungen. Sie bietet hervorragenden Sehkomfort dank ihrer Form und der tief platzierten LED. Bietet eine symmetrische und eine asymmetrische Ausführung, die jeweils spezifische Beleuchtungsanforderungen erfüllen. Der dimmbare Treiber zur Anpassung der Lichtintensität gemäß den Anforderungen des jeweiligen Raums und Zeitpunkts ist in beiden Ausführungen inbegriffen.

Un lampione con un design contemporaneo a forma di zigzag concepito per integrarsi completamente nell'architettura e ideale per spazi privati ad uso pubblico, come centri commerciali, hotel e complessi residenziali. Offre un ottimo comfort visivo grazie alla sua forma e al fatto che il LED si trova su un piano inferiore. È dotato di una versione Simmetrica ed Asimmetrica, ciascuna concepita per specifiche esigenze di illuminazione. Entrambe le versioni includono un driver regolabile che permette di adattare l'intensità della luce, in base alle necessità di ogni spazio o momento.

Ideal zur Erzielung der höchsten Lichtintensität nach vorn und zur Maximierung des seitlichen visuellen Komforts. Dazu werden einzelne LED hinter den symmetrischen Reflektoren eingesetzt, die wiederum hinter Blendschutzvorrichtungen verborgen sind. Dadurch wird ein ausgezeichneter UGR-Wert von unter 10 erreicht.

Ideale per ottenere il massimo flusso luminoso, frontalmente, e massimizzare il comfort visivo, ai lati. Per ottenere ciò, vengono utilizzati singoli LED nascosti dietro i riflettori simmetrici che sono, a loro volta, nascosti dietro gli anti abbaglianti. Tutto ciò per ottenere un incredibile UGR, inferiore a 10.

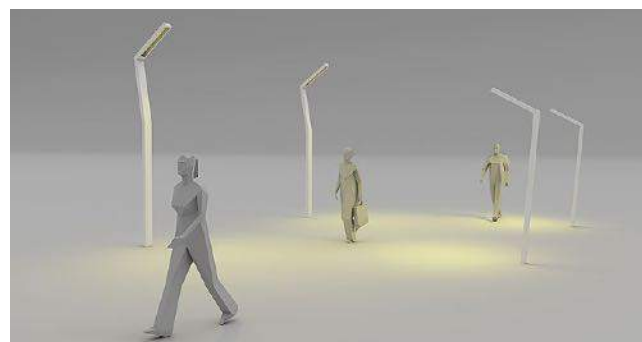

Asymmetrische Option Opzione Asimmetrica

Ideal, um den höchsten Lichtfluss zu den Seiten zu erzielen und den Sehkomfort nach vorne zu maximieren. Um dies zu erreichen, werden strategisch platzierte, hocheffiziente asymmetrische Optiken verwendet, die eine hervorragende Beleuchtung auf allen Arten von Straßen, Wegen und auch Radwegen ermöglichen. Das Beste ist, dass dadurch viel Arbeitszeit gespart werden kann, da die Leuchten in großem Abstand voneinander installiert werden können, ohne die Homogenität des Lichts zu verlieren.

Ideale per ottenere il massimo flusso luminoso ai lati e massimizzare il comfort visivo, frontalmente. Per ottenere ciò, vengono utilizzate ottiche asimmetriche ad alta efficienza posizionata strategicamente, che consentono un'illuminazione eccellente su tutti i tipi di strade, sentieri o persino piste ciclabili. Il principale vantaggio è che permette di economizzare il lavoro poiché gli apparecchi possono essere installati a grande distanza, l'uno dall'altro, senza perdere omogeneità di luce.



Hoher visueller Komfortl Alto comfort visivo

Die strategische Anordnung der LED mit hochwertigen Optiken garantiert einen ausgezeichneten visuellen Komfort.

Il posizionamento strategico dei LED, con ottiche di alta qualità, garantiscono un ottimo comfort visivo.



Schnelle Installation Installazione rapida

Mit wasserdichtem Klemmblock, doppelter Kabeleinführung und Montageset mit Schablone zur Erleichterung und Gewährleistung einer zuverlässigen Befestigung am Boden.

Include una morsettieria stagna con doppio ingresso dei cavi ed un set di bulloni con il modello, per facilitare e garantire un fissaggio a pavimento affidabile.



Einfache Wartung Manutenzione facile

Bei einem Ausfall lassen sich die LED-Module durch einfaches Öffnen einer Abdeckung am hinteren Bereich des Leuchtkopfes einfach austauschen. Auch der Treiber lässt sich im Störfall schnell austauschen, da er leicht zugänglich im Inneren der Leuchte platziert ist. Der Zugang erfolgt durch einfaches Öffnen der Abdeckung an der Rückseite des Leuchtensockels.

I moduli LED sono facilmente sostituibili in caso di guasto, semplicemente aprendo un coperchio nascosto sul retro della testa. Anche il driver può essere sostituito rapidamente, in caso di guasto, poiché è strategicamente posizionato all'interno del lampione; vi si accede semplicemente, aprendo il rivestimento della porta anteriore che si trova nella parte posteriore della base del lampione.



Langlebigkeit Durabilità

Mit einem Gehäuse aus extrudiertem Aluminium, das die Lebensdauer des Produkts maximiert und seine Installation in nassen Umgebungen oder sogar direkt am Meer ermöglicht. Auch der Innenbereich ist so ausgelegt, dass er starken Witterungseinflüssen standhält.

Dotato di un corpo in alluminio estruso per massimizzare la vita utile del prodotto, permette la sua installazione in ambienti umidi o anche sul lungomare. Internamente, è stato progettato per resistere alle intemperie.



ZIGZAG

Zigzag Symmetrical

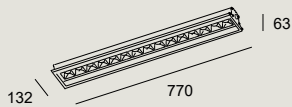

DIF MAT		IP	IK	50000h	3		SEA SIDE		BREEM
GLA		65	03	L80 B20	MacAdam	2.7 m	SUITABLE	0-10V	

Z5 ●

LED						
K	CRI	W LED	W Total	Real Lm	Optics	Code
3000	80	55.8	63.4	4264	Flood 51°	60-E102 - Z5 - CL
4000	80	55.8	63.4	4264	Flood 51°	60-E102 - Z5 - CM

100-240V 50-60Hz

ZIGZAG

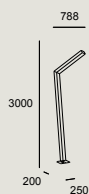

SEA SIDE
SUITABLE

Z5 ●

Code
81-E102 - Z5 - Z5

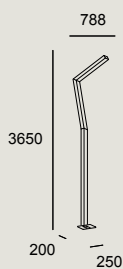

SEA SIDE
SUITABLE

Z5 ●

Code
81-E103 - Z5 - Z5

mitgeliefertes allgemeines Zub.
Access. comuni inclusi

Bolzen und Schablone
Bulloni e cornice di fissaggio

**nicht mitgeliefertes
allgemeines Zub.**
Access. comuni non inclusi

Kratzfester Lack in Z5-Grau
Vernice antigraffio in grigio Z5

71-E117-Z5-00

ZIGZAG

Zigzag Asymmetrical

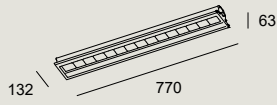

DIF MAT		IP	IK	50000h	3		SEA SIDE		BREEAM
GLA		65	03	L80 B20	MacAdam		2.7 m		

Z5 ●

LED						
K	CRI	W LED	W Total	Real Lm	Optics	Code
3000	80	56.4	62.1	5595	Horizontal 105°	60-E000 - Z5 - CL
4000	80	56.4	62.1	5829	Horizontal 105°	60-E000 - Z5 - CM
		100-240V 50-60Hz				

ZIGZAG

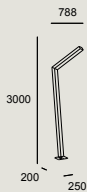

SEA SIDE
SUITABLE

Z5 ●

Code
81-E102 - Z5 - Z5

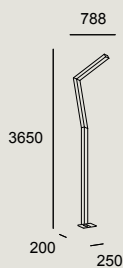

SEA SIDE
SUITABLE

Z5 ●

Code
81-E103 - Z5 - Z5

mitgeliefert **allgemeines Zub.**
Access. comuni inclusi

Bolzen und Schablone
Bulloni e cornice di fissaggio

nicht mitgeliefert **allgemeines Zub.**
Access. comuni non inclusi

Kratzfester Lack in Z5-Grau
Vernice antigraffio in grigio Z5

71-E117-Z5-00



Citizen

DIF MAT
PC



BODY MAT		50000h	2	IP	IK	
ST,AL		L80 B20	MacAdam	65	10	0-10V

Z5 ●

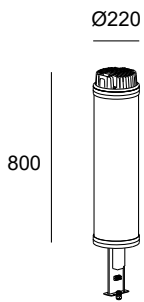

LED					
K	CRI	W LED	W Total	Real Lm	Code
3000	80	54	59	4257	60-3239 - Z5 - CL
100-240V		50-60Hz			

BODY MAT
ST

Z5 ●

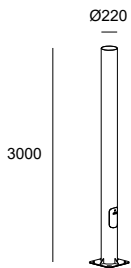

Code
81-3239 - Z5 - Z5

mitgeliefertes allgemeines Zub.
Access. comuni inclusi

Bolzen und Schablone
Bulloni e cornice di fissaggio

Leuchenschlüssel
Chiave per sportello lampione

Lyon

BODY MAT	DIF MAT
AL	PC



	IP 65	IK 10	50000h L80 B20	3 MacAdam	UGR <16	SEA SIDE SUITABLE	BREEAM	 1-10V
--	----------	----------	-------------------	--------------	------------	----------------------	--------	-----------

34 Z5

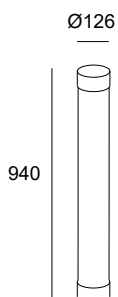

LED						
K	CRI	W LED	W Total	Real Lm	Code	
3000	80	50.3	59	4580	60-9809 - 34 - Z5	CL
4000	80	50.3	59	5389	60-9809 - 34 - Z5	CM

100-240V 50-60Hz

SEA SIDE SUITABLE

34 Z5

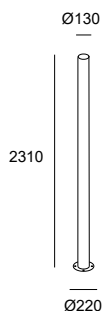

Code
81-9915 - 34 - 34 Z5 - Z5

nicht inklusive / Non incluso
Bodenbefestigungsbolzen Bulloni di fissaggio al suolo
71-9957-48-48

SEA SIDE SUITABLE

34 Z5

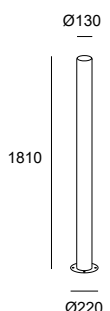

Code
81-9914 - 34 - 34 Z5 - Z5

nicht inklusive / Non incluso
Bodenbefestigungsbolzen Bulloni di fissaggio al suolo
71-9957-48-48



Proud Symmetrical



BODY MAT	DIF MAT		IP	IK	50000h	3		SEA SIDE	BREEAM
AL	PC		66	10	L80 B20	MacAdam	0.4 m	SUITABLE	
ON-OFF									

Z5 ●

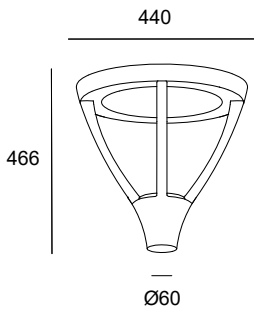

LED					
K	CRI	W LED	W Total	Real Lm	Code
3000	80	40	44.9	3110	60-9913 - Z5 - CL
3000	80	76.7	85.4 W	5223	
4000	80	40	44.9	3110	60-9913 - Z5 - CM
4000	80	76.7	85.4	5695	

	ON-OFF	100-240V	50-60Hz
--	--------	----------	---------

nicht inklusive / Non incluso

Bodenbefestigungsbolzen
Bulloni di fissaggio al suolo

71-E213-48-48

BODY MAT
ST

Z5 ●

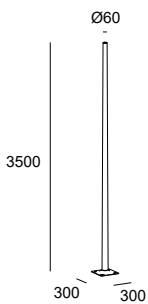

Code
81-E000 - Z5 - Z5

nicht inklusive / Non incluso

Kratzfester Lack in Z5-Grau
Vernice antigraffio in grigio Z5

71-E117-Z5-00

Bodenbefestigungsbolzen
Bulloni di fissaggio al suolo

71-E213-48-48

Proud Asymmetrical



BODY MAT AL	DIF MAT PC		IP 65	IK 10	50000h L80 B20	3 MacAdam	UGR <22	LOW FLICKER	
SEA SIDE SUITABLE		BREEAM							

Z5 ●

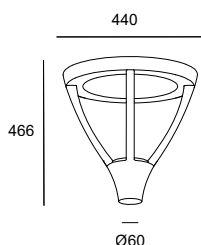

LED					
K	CRI	W LED	W Total	Real Lm	Code
3000	80	44	46.4	4879	60-E082 - Z5 - CL
4000	80	44	46.4	5227	60-E082 - Z5 - CM
100-277V		50-60Hz			

nicht inklusive / Non incluso

Bodenbefestigungsbolzen
Bulloni di fissaggio al suolo **71-E213-48-48**

BODY MAT ST

Z5 ●

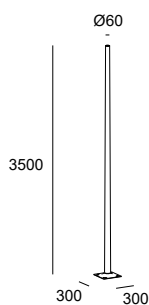

Code 81-E000 - Z5 - Z5

nicht inklusive / Non incluso

Kratzfester Lack in Z5-Grau
Vernice antigraffio in grigio Z5 **71-E117-Z5-00**

Bodenbefestigungsbolzen
Bulloni di fissaggio al suolo **71-E213-48-48**





Wandleuchten

Lampade da parete



Max

759

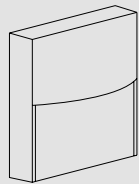

Sam

765

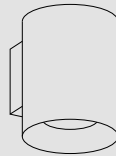

Cosmos

769

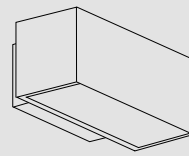

Afrodita

773



Nemesis

786

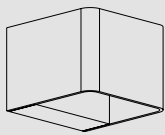

Wilson

788

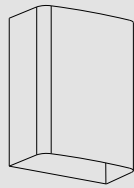

Clous

790

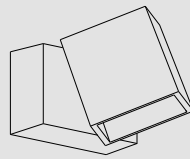

Cubus

791

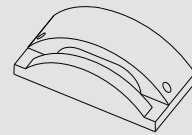

Finestra

793

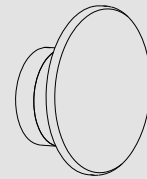

Moal

797

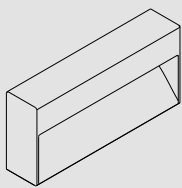

Arc

800



Kössel

802

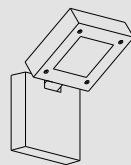

Modis

807

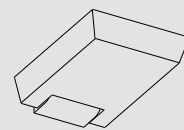

Blade

812



Skat

815



Mega

818

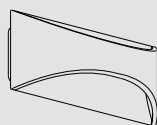

Venus

820

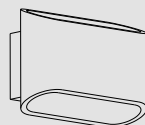

Diago

820

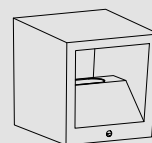

Simenti

821



Darwin

821



Wandleuchten

Lampade da parete

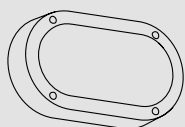

Basic

823



Curie

830



Max

BODY MAT	DIF MAT		50000h
AL	GLA		L80 B20



Video ansehen
Guarda il video

Die Max-Wandleuchte bietet drei Varianten für uni- und bidirektionale Lichtrichtung sowie eine weitere Größe pro Modell, um sich an alle Projekte anzupassen. Durch den Einsatz von austauschbaren LED-Modulen, die einen hohen Lichtkomfort mit einem UGR von < 12 und eine hohe Farbwiedergabe mit CRI90 bieten, verfügt die Leuchte über ein ökologisches Design. Alle Modelle können mit den von LEDES C4 angebotenen Farben individuell gestaltet werden.

Max applique è disponibile in tre versioni a mono e doppia emissione e in una nuova misura per ciascun modello per potersi adattare a tutti i progetti. Il suo design risponde a un parametro ecologico grazie all'uso di moduli LED sostituibili che offrono un elevato comfort visivo UGR < 12 e un'elevata riproduzione cromatica con un CRI90. Tutte le opzioni sono personalizzabili con i colori offerti dalla LEDES C4.

Verschiedene Größen Diverse misure

Die Wandleuchte Max ist in verschiedenen Größen und mit uni- oder bidirektionalem Licht und sowohl in ON-OFF- als auch in DALI-Ausführung erhältlich, um sich an jeden Bedarf anzupassen.

Max Applique è disponibile in diverse misure e nei formati Mono e Doppia Emissione per soddisfare ogni esigenza, sia in versione ONOFF che DALI.

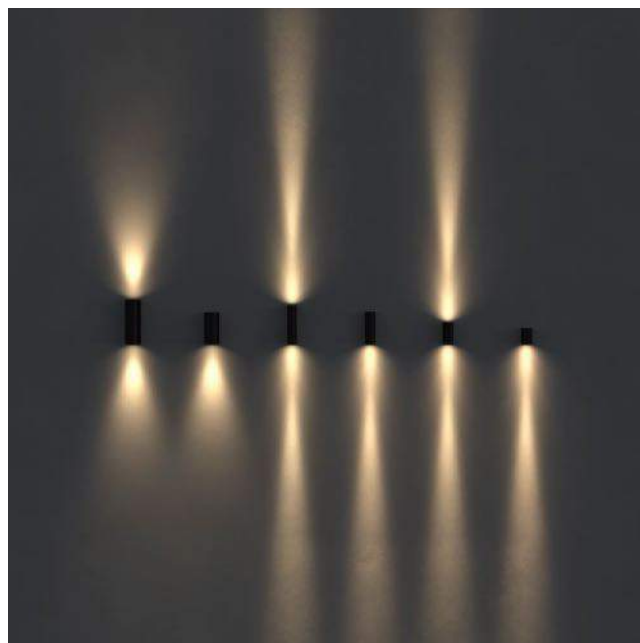

Umfangreiches Zubehör Ampia gamma di accessori

Die Kollektion beinhaltet eine große Auswahl an Zubehör wie einen elliptischen Diffusor, einen quadratischen Diffusor, ein Wabenraster und eine Weichzeichnerlinse.

La collezione dispone di un'ampia gamma di accessori quali diffusore ellittico, diffusore quadrato, pannello a nido d'ape e diffusore dell'alone.













MAX

Max Wall Fixture Single emission















Codebeispiel / Esempio di codice: AI19-P4V9S10SZ5

Model	W	K/ Cri/ Real lm	Optics	Source	Finishes
AI19 - Unifirektional Mono emissione  	P4 4W	V9 2700K CRI90/286 lm	S1 9°	OS  ON-OFF 220-240V 50-60Hz	Z5 
		W9 3000K CRI90/286 lm			14* 
		X9 4000K CRI90/286 lm			60* 
	P7 6,5W	V9 2700K CRI90/519 lm	S2 17°	OS  ON-OFF 220-240V 50-60Hz	34* 
		W9 3000K CRI90/519 lm	M2 27°		J6* 
		X9 4000K CRI90/519 lm	F1 50°		E3* 
					DL* 



Codebeispiel / Esempio di codice: AI23-P6V9S1DUZ5

Model	W	K/ Cri/ Real lm	Optics	Source	Finishes	
AI23 - Unidirektional Mono emissione  	P6 6W	V9 2700K CRI90/373 lm	S1 9°	DU  DALI-2 100-277V 50-60Hz	Z5 	
		W9 3000K CRI90/373 lm			XB  CASAMBI 220-240V 50-60Hz	14* 
		X9 4000K CRI90/373 lm				60* 
	P8 8,9W	V9 2700K CRI90/610 lm	S2 17°	DU  DALI-2 100-277V 50-60Hz	34* 	
		W9 3000K CRI90/610 lm	M2 27°		XB  CASAMBI 220-240V 50-60Hz	J6* 
		X9 4000K CRI90/610 lm	F1 50°			E3* 
				DL* 		

nicht mitgeliefertes allgemeines Zub.
Access. comuni non inclusi

5 Wabenraster
5 pannelli a nido d'ape

71-E131-00-00

5 Lichtfilter für gestreute Lichtkegel
5 filtri per l'emissione di luce diffusa

71-E133-00-00

5 Lichtfilter für quadratische Lichtkegel
5 filtri per l'emissione di luce quadrata

71-E135-00-00

5 Lichtfilter für elliptische Lichtkegel
5 filtri per emettere luce ellittica

71-E141-00-00

*Fragen Sie unser Verkaufsteam nach den Lieferbedingungen.











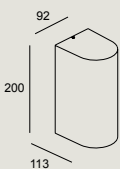

Consultare i termini e le condizioni di consegna al nostro team commerciale.

MAX

Max Wall Fixture Single emission



Codebeispiel / Esempio di codice: AT19-18V9S3OSZ5

Model	W	K/ Cri/ Real lm	Optics	Source	Finishes
AT19 - Unidirektional Mono emissione  	18 17,3W	V9 2700K CRI90 1902 lm	S3 21°	OS  ON-OFF 220-240V 50-60Hz	Z5 
		W9 3000K CRI90 2047 lm	M3 31°	DU  DALI-2 100-277V 50-60Hz	14* 
		X9 4000K CRI90 2191 lm	F1 40°	XB  CASAMBI 220-240V 50-60Hz 	60*  34*  J6*  E3*  DL* 



nicht inklusive / Non incluso

5 Lichtfilter für gestreute Lichtkegel/ 5 filtri per l'emissione di luce diffusa	71-E260-00-00
5 Lichtfilter für elliptische Lichtkegel / 5 filtri per emettere luce ellittica	71-E261-00-00
5 Lichtfilter für quadratische Lichtkegel / 5 filtri per l'emissione di luce quadrata	71-E262-00-00
5 Wabenraster / 5 pannelli a nido d'ape	71-E263-00-00

*Fragen Sie unser Verkaufsteam nach den Lieferbedingungen.

Consultare i termini e le condizioni di consegna al nostro team commerciale.

MAX

Max Wall Fixture Double Emission

BODY MAT
AL



IK
10

SEA SIDE
SUITABLE

IP
66

ON-OFF

Codebeispiel / Esempio di codice: AI21-P8V9S10SZ5

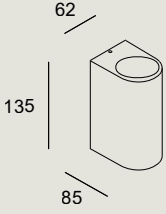
Model	W	K/ Cri/ Real lm	Optics	Source	Finishes
AI21 - Bidirektional Doppia emissione  	P8 8W	V9 2700K CRI90/572 lm	S1 9°	OS ON-OFF 220-240V 50-60Hz	Z5
		W9 3000K CRI90/572 lm			14*
		X9 4000K CRI90/572 lm			60*
	11 10,5W	V9 2700K CRI90/805 lm	S7 8,6° + 17°	OS ON-OFF 220-240V 50-60Hz	34*
		W9 3000K CRI90/805 lm	S8 8,6° + 27°		J6*
		X9 4000K CRI90/805 lm	S9 8,6° + 50°		E3*
	13 13W	V9 2700K CRI90 1038 lm	S2 17° + 17°	OS ON-OFF 220-240V 50-60Hz	DL*
			M2 27° + 27°		
		W9 3000K CRI90 1038 lm	F1 50° + 50°		
M5 27° + 50°					
X9 4000K CRI90 1038 lm		S5 17° + 27°			
		S6 17° + 50°			

MAX

Max Wall Fixture Double Emission

BODY MAT
AL



IK
10



IP
66

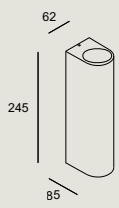

Codebeispiel / Esempio di codice: AI24-12V9S1DUZ5

Model	W	K/ Cri/ Real lm	Optics	Source	Finishes	
AI24 - Bidirektional Doppia emissione  	12 12W	V9 2700K CRI90/747 lm	S1 9°	DU DALI-2/100-277V 50-60Hz	Z5	
		W9 3000K CRI90/747 lm			XB CASAMBI 220-240V 50-60Hz	14*
		X9 4000K CRI90/747 lm			60*	
	14 14,1W	V9 2700K CRI90/957 lm	S7 8,6° + 17°	DU DALI-2/100-277V 50-60Hz	34*	
		W9 3000K CRI90/957 lm	S8 8,6° + 27°		J6*	
		X9 4000K CRI90/957 lm	S9 8,6° + 50°		E3*	
	17 17,8W	V9 2700K CRI90/1221 lm	S2 17° + 17°	DU DALI-2 100-277V 50-60Hz	DL*	
			M2 27° + 27°			
		W9 3000K CRI90/1221 lm	F1 50° + 50°			
M5 27° + 50°						
X9 4000K CRI90/1221 lm		S5 17° + 27°				
		S6 17° + 50°				

nicht mitgeliefertes allgemeines Zub.
Access. comuni non inclusi

5 Wabenraster
5 pannelli a nido d'ape

71-E131-00-00

5 Lichtfilter für gestreute Lichtkegel
5 filtri per l'emissione di luce diffusa

71-E133-00-00

5 Lichtfilter für quadratische Lichtkegel
5 filtri per l'emissione di luce quadrata

71-E135-00-00

5 Lichtfilter für elliptische Lichtkegel
5 filtri per emettere luce ellittica

71-E141-00-00

MAX**Max Wall Fixture
Double emission**

Codebeispiel / Esempio di codice: AT21-33V9S30SZ5

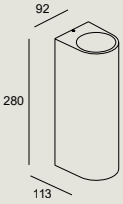
Model	W	K/ Cri/ Real lm	Optics	Source	Finishes
AT21 - Bidirektional Doppia emissione  	33 31,5W	V9 2700K CRI90 3804 lm	S3 21° + 21°	OS ON-OFF 220-240V 50-60Hz	Z5
		W9 3000K CRI90 4094 lm	M3 31° + 31°	DU DALI-2 100-277V 50-60Hz	14*
		X9 4000K CRI90 4382 lm	F1 40° + 40°	XB CASAMBI 220-240V 50-60Hz	60*
			M5 31° + 40°		34*
			S5 21° + 31°		J6*
			S6 21° + 40°		E3*
					DL*

nicht inklusive / Non incluso

5 Lichtfilter für gestreute Lichtkegel / 5 filtri per l'emissione di luce diffusa	71-E260-00-00
5 Lichtfilter für elliptische Lichtkegel / 5 filtri per emettere luce ellittica	71-E261-00-00
5 Lichtfilter für quadratische Lichtkegel / 5 filtri per l'emissione di luce quadrata	71-E262-00-00
5 Wabenraster / 5 pannelli a nido d'ape	71-E263-00-00

*Fragen Sie unser Verkaufsteam nach den Lieferbedingungen.

Consultare i termini e le condizioni di consegna al nostro team commerciale.



Sam

BODY MAT	DIF MAT		50000h	3
AL	PC		L80 B20	MacAdam



Eleganz, Persönlichkeit und vielseitige Betriebsmöglichkeiten mit einem Profil ohne Design-Extravaganzen. Sam ist als Wandleuchte für die Beleuchtung von Durchgangsbereichen vorgesehen und erfüllt die spezifischen Raumanforderungen auf einfache und flexible Weise. Die flache Baugröße macht statt des aufwendigen Wandeinbaus eine einfache Aufputzmontage möglich.

Eleganza, personalità e versatilità nelle modalità di funzionamento in un profilo sinuoso di design. Sam è pensata per illuminare zone di passaggio dalla parete, adattandosi alle esigenze di illuminazione di ciascuno spazio in modo agile e molto semplice. Con un corpo poco profondo, viene installata in superficie, senza bisogno di essere incassata.

Optikblock mit 3 sinnvollen Stellungen

Blocco ottico con 3 utili posizioni

Die Anforderungen an die Beleuchtung sind von verschiedenen Faktoren wie der Tageszeit, der Notwendigkeit, verschiedene Atmosphären im gleichen Raum zu schaffen bzw. größere oder kleinere Bereiche auszuleuchten. Zu diesem Zweck verfügt Sam über einen bedienfreundlichen internen Mechanismus, mit dem der Abstand zwischen dem Optikblock und dem Diffusor verstellt und damit je nach Größe der auszuleuchtenden Bodenfläche verschiedene Lichtstärken erzeugt werden können.

Le esigenze di illuminazione possono cambiare per diversi fattori, per fasce orarie, per la necessità di creare ambienti diversi in uno stesso spazio o per la necessità di illuminare zone di maggiori o minori dimensioni. Tenendo in considerazione questo aspetto, Sam è provvista di un meccanismo interno, facilmente azionabile, che consente di regolare la distanza del blocco ottico rispetto al diffusore, per creare così diversi livelli di luminosità in funzione dei metri di pavimento da illuminare.

Sam 180 mm

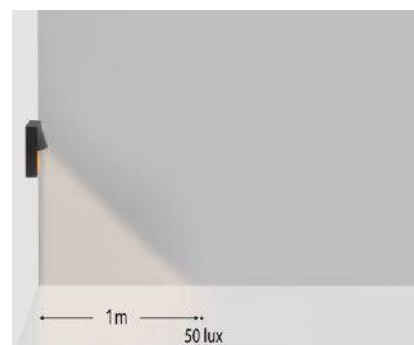
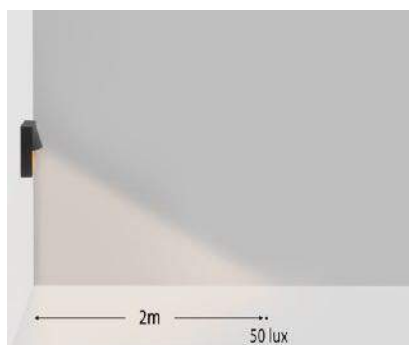
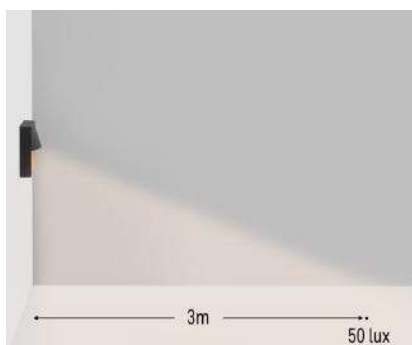

Sam 140 mm

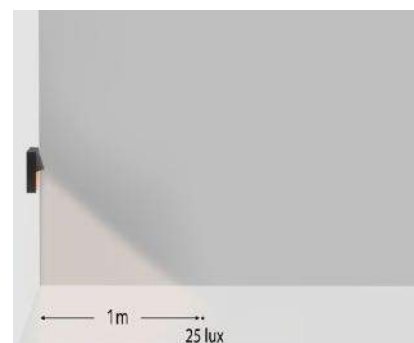
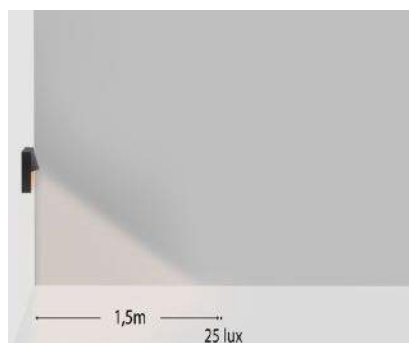
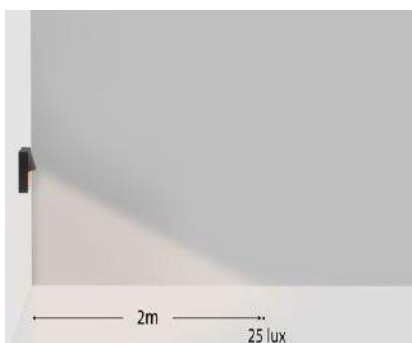

CCT-Switch Switch CCT

Mit dem eingebauten CCT-Switch kann die Farbtemperatur von wärmeren auf kühlere Farbtöne im Bereich von 2700K, 3200K und 4000K umgestellt werden.

Dispone di uno Switch CCT incorporato che consente di cambiare la temperatura di colore, passando da una tonalità calda a un'altra più fredda, con un range di 2700K, 3200K e 4000K.

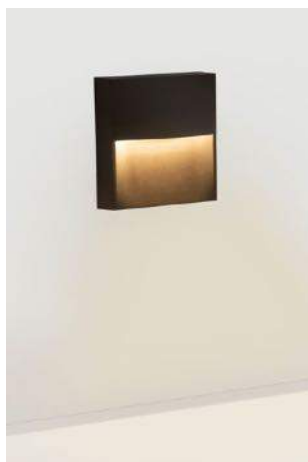
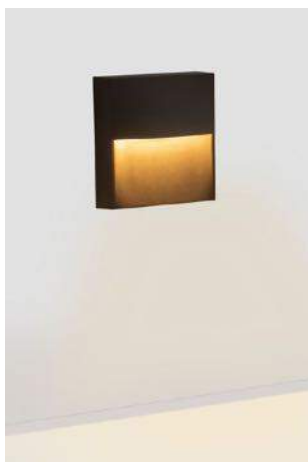

Einfache Installation Installazione facile



Die Montagefreundlichkeit ist ein wichtiger Aspekt bei der Wahl des Leuchtenmodells, das die Anforderungen eines Projekts erfüllt. Für die Installation von sind weder Vorschaltgeräte noch Unterputzdosen erforderlich, da der Treiber bereits in die ultraflache Bauform integriert ist. Zudem verfügt Sam über einen doppelten Kabelausgang, um die Reiheninstallation zu vereinfachen. Das größere Modell verfügt über einen vierfachen Kabelausgang, damit bei der Wahl der DALI-Option Stromkabel und DALI-Signalkabel getrennt verlegt werden können.

La facilità di installazione di un apparecchio per l'illuminazione è una qualità sempre molto apprezzata al momento di scegliere il modello più adatto alle esigenze del progetto. Sam non richiede l'installazione di dispositivi né di scatole da incasso nella parete, poiché il suo design ha già il driver incorporato. Inoltre, Sam è provvisto di una doppia uscita del cavo per semplificare l'installazione in serie. Il modello più grande ha un'uscita del cavo quadrupla, in questo modo, nel caso si scelga l'opzione DALI, sarà possibile passare cavi di alimentazione e cavi di segnale DALI in modo indipendente.

Erhältliche Ausführungen Finiture disponibili

Sam wird standardmäßig in der Z5-Ausführung geliefert und kann mit der umfangreichen The Colours-Palette von LEDS C4 individuell gestaltet werden.

Sam si presenta in finitura 75 di serie e può essere personalizzato con l'ampia gamma The Colours offerta da LEDS C4.



SAM

	IP 66	IK 10		ON-OFF	SWITCH CCT SW 2700-3200-4000	SEA SIDE SUITABLE
--	----------	----------	--	--------	---------------------------------	----------------------

14* 34* 60* DL* E3* J6* Z5

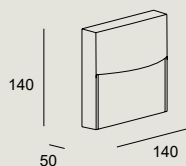

LED						
K	CRI	W LED	W Total	Real Lm	Code	
SW 2700-3200-4000	80	3.2	3.5	269	14	
					34	
					60	
					05-E059 - DL - EH	
					E3	
J6						
Z5						
 220-240V 50-60Hz						

	IP 66	IK 10		ON-OFF	SWITCH CCT SW 2700-3200-4000	SEA SIDE SUITABLE
--	----------	----------	--	--------	---------------------------------	----------------------

14* 34* 60* DL* E3* J6* Z5

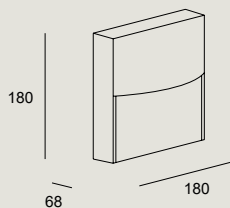

LED						
K	CRI	W LED	W Total	Real Lm	Code	
SW 2700-3000-4000	80	16	17.4	1444	14	
					34	
					60	
					05-E058 - DL - EH	
					E3	
J6						
Z5						
SW 2700-3200-4000	80	16	17.4	1444	14	
					34	
					60	
					05-E068 - DL - EH	
					E3	
J6						
Z5						
 05-E058 DALI-2 120-277V 50-60Hz 05-E068 ON-OFF 100-240V 50-60Hz						

*Fragen Sie unser Verkaufsteam nach den Lieferbedingungen.

Consultare i termini e le condizioni di consegna al nostro team commerciale.



Cosmos

BODY MAT	DIF MAT		50000h
AL	GLA		L80 B20



Die Cosmos-Kollektion von Wand- und Deckenleuchten wurde nach dem Deco-Tech-Konzept entworfen und dient zur Beleuchtung der Fassaden und Terrassen von Hotels, öffentlichen Bereichen und Wohnhäusern, um ihnen einen dekorativen Touch zu verleihen.

La collezione di applique e plafoniere Cosmos è progettata secondo il concetto deco-tech ed ha lo scopo di illuminare, professionalmente, facciate e terrazze di hotel, aree pubbliche e residenze, con un tocco decorativo.



Beleuchtungsoptionen Opzioni dell'illuminazione

Mit optionalem doppeltem Lichtaustritt nach oben und unten geht sie in ihrer dekorativen Qualität noch einen Schritt weiter. Dispone di una doppia emissione luminosa opzionale, verso l'alto e verso il basso, per fare un ulteriore passo in avanti nella sua qualità decorativa.



Höchste Eleganz Massima eleganza

Die beiden mitgelieferten Zierringe und die versteckte Hardware ermöglichen eine maximale Integration in den Raum. I due anelli decorativi inclusi e le viti nascoste, consentono la massima integrazione nello spazio.



COSMOS

Cosmos Single emission

IP	IK		BREEAM
66	06	ON-OFF	

Z5 ●

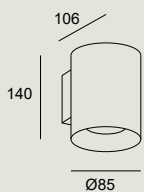

LED						
K	CRI	W LED	W Total	Real Lm	Optics	Code
3000	80	11	13	760	Spot 17°	05-9952 - Z5 - CL
4000	80	11	13	819	Spot 17°	05-9952 - Z5 - CM
		100-240V 50-60Hz				

inklusive / Incluso

15°- und 36°-Strahler
Riflettori 15° e 36°

Dekorative Abschlüsse
Modanature decorative

IP	IK		BREEAM
66	06	ON-OFF	

Z5 ●

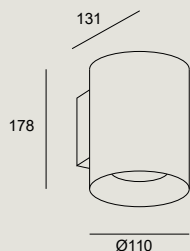

LED						
K	CRI	W LED	W Total	Real Lm	Optics	Code
3000	80	23	26.1	1823	Spot 16°	05-9954 - Z5 - CL
4000	80	23	26.1	1823	Spot 16°	05-9954 - Z5 - CM
		100-240V 50-60Hz				

inklusive / Incluso

15°- und 36°-Strahler
Riflettori 15° e 36°

Dekorative Abschlüsse
Modanature decorative

IP	IK		BREEAM
66	07	ON-OFF	

Z5 ●

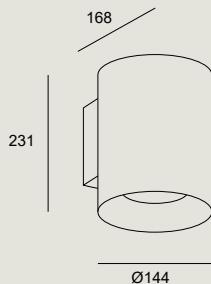

LED						
K	CRI	W LED	W Total	Real Lm	Optics	Code
3000	80	33	38.6	2367	Spot 16°	05-9956 - Z5 - CL
4000	80	33	38.6	2534	Spot 16°	05-9956 - Z5 - CM
		100-240V 50-60Hz				

inklusive / Incluso

15°- und 36°-Strahler
Riflettori 15° e 36°

Dekorative Abschlüsse
Modanature decorative

COSMOS

Cosmos Double emission

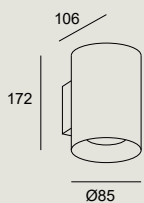

IP	IK		BREEAM
66	06	ON-OFF	

Z5 ●

LED						
K	CRI	W LED	W Total	Real Lm	Optics	Code
3000	80	10.5	11.8	912	Spot 17°	05-9953 - Z5 - CL
4000	80	10.5	11.8	960	Spot 17°	05-9953 - Z5 - CM
		100-240V		50-60Hz		

inklusive / Incluso

15°- und 36°-Strahler

Riflettori 15° e 36°

Dekorative Abschlüsse

Modanature decorative

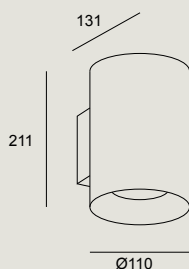

IP	IK		BREEAM
66	06	ON-OFF	

Z5 ●

LED						
K	CRI	W LED	W Total	Real Lm	Optics	Code
3000	80	21	24.5	1823	Spot 16°	05-9955 - Z5 - CL
4000	80	21	24.5	1823	Spot 16°	05-9955 - Z5 - CM
		100-240V		50-60Hz		

inklusive / Incluso

15°- und 36°-Strahler

Riflettori 15° e 36°

Dekorative Abschlüsse

Modanature decorative

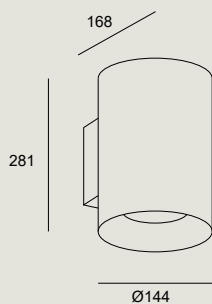

IP	IK		BREEAM
66	07	ON-OFF	

Z5 ●

LED						
K	CRI	W LED	W Total	Real Lm	Optics	Code
3000	80	31	35	2710	Spot 16°	05-9957 - Z5 - CL
4000	80	31	35	2901	Spot 16°	05-9957 - Z5 - CM
		100-240V		50-60Hz		

inklusive / Incluso

15°- und 36°-Strahler

Riflettori 15° e 36°

Dekorative Abschlüsse

Modanature decorative



Afrodita

Afrodita Infinite

P. 775

Architektonische Integration
Integrazione architettonica



1000 x 105 mm

20,3 - 29 W

Flood



14 ○ Z5 ●



Afrodita LED

P. 776

Grundbeleuchtung
Luce generale



220 x 90 mm



300 x 120 mm

11,5 - 39 W
Emergency

Flood



14 ○ Z4 ● Z5 ●



Afrodita Power LED

P. 778

Vertikale Beleuchtung
Luce verticale



100 x 135 mm



100 x 150 mm

10,5 - 17,4 W

Medium



14 ○ 34 ● 60 ●

DL ● E3 ● J6 ●

Z5 ●

Afrodita Tech

P. 778

Lichteffekte
Effetti di luce



120 x 120 mm



215 x 215 mm

12 - 37,8 W

Flood

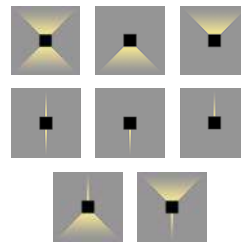

Z5 ●

Afrodita GU10

P. 777

Betrieb mit Glühbirne
Uso con lampadina



83 x 115 mm



83 x 208 mm

1 / 2 x max. 8 W



14 ○ 34 ● Z5 ●

Afrodita

BODY MAT	DIF MAT	
AL	GLA	

Eine Familie aus einfachen und modernen Wandleuchten für die Außenbeleuchtung im Wohn- und Hotelbereich, die ideal zur Ausleuchtung von Eingängen und Wegen von der Wand aus konzipiert sind. Besonders geeignet für öffentliche Bereiche. Die Kollektion umfasst die Produktreihen Afrodita LED, Afrodita Power LED, Afrodita Tech, Afrodita Infinite, Afrodita E-27 und Afrodita GU10, die jeweils ein spezifisches Design aufweisen, um unterschiedliche Anforderungen zu erfüllen.

Famiglia di applique, semplici e moderne, per l'illuminazione di esterni residenziali e alberghieri, ideale per segnalare ingressi e percorsi, dalla parete. Questo prodotto funziona molto bene negli spazi pubblici. La collezione comprende le gamme Afrodita LED, Afrodita Power LED, Afrodita Tech, Afrodita Infinite, Afrodita E-27 e Afrodita GU10, ciascuna con un design specifico per soddisfare le diverse esigenze.

Semiopal-Diffusoren Diffusori semi opalini

Alle Lichtstromausgänge werden durch Semiopal-Diffusoren abgeschirmt, um ein optimales Beleuchtungsdesign zu erzielen. Tutti i flussi luminosi emessi sono filtrati da diffusori semi-opalini, per ottenere progetti di illuminazione ottimali.



Maximale Lebensdauer Massima durabilità

Afrodita besteht aus Aluminium, was eine perfekte Wärmeab-
leitung ermöglicht und die Lebensdauer des Produkts erhöht. Afrodita è realizzato in alluminio, permettendo la perfetta dissipazione del calore e massimizzando la vita utile del prodotto.

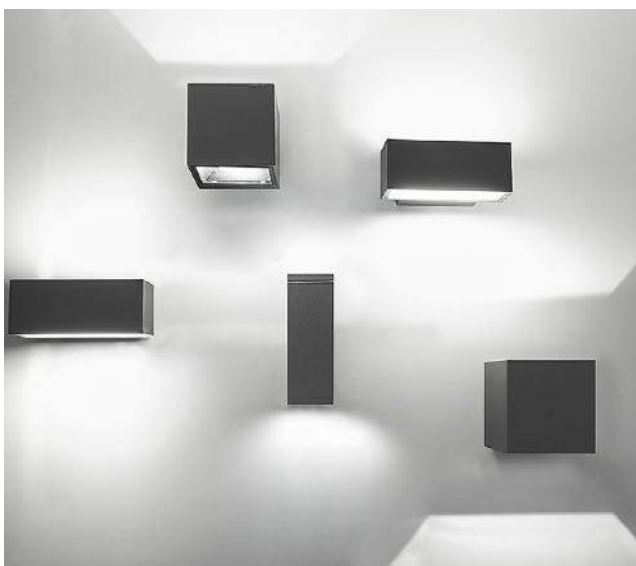

AFRODITA INFINITE



Die Aphrodite Infinite-Wandleuchte kann in Reihe geschaltet werden, um sich an die Länge des zu beleuchtenden Bereichs anzupassen.

L'applicque Afrodita Infinite offre un'opzione di installazione in serie per adattarsi alla lunghezza dell'area da illuminare.

Verschiedene Formate Diversi formati



Die mit Einfach- oder Doppelstrahler erhältliche Kollektion kann horizontal oder vertikal in Reihe geschaltet werden.

Disponibile nel formato mono o doppia emissione, la collezione può essere installata in serie, in modo orizzontale o verticale.

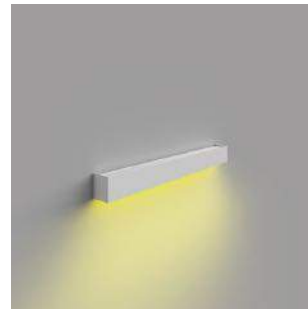

Smart

Afrodita Infinite ist in Ausführungen mit eingebauter Bluetooth Mesh-Casambi-Technologie erhältlich, mit der Räume vielseitiger gestaltet werden können, da das Einschalten und die Lichtintensität gesteuert werden können.

Afrodita Infinite dispone di versioni con tecnologia Bluetooth Mesh Casambi incorporata, aumentando la versatilità degli spazi in grado di controllare l'accensione e il flusso luminoso.

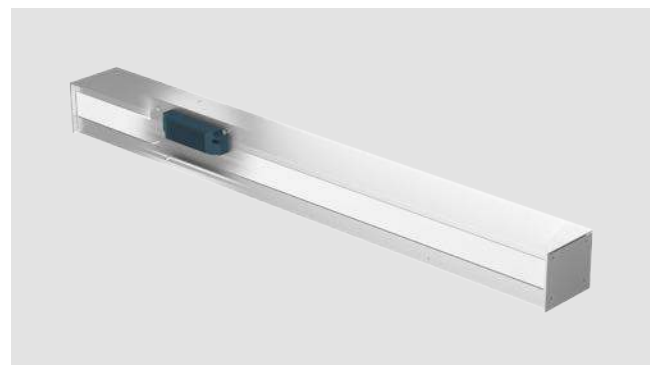

AFRODITA LED



Afrodita LED ist in zwei Größen in drei Farben erhältlich, als Einfach- oder Doppelstrahlerausführung mit zwei Farbtemperaturen (3000 K und 4000 K).

Si presenta in due misure, Afrodita LED è disponibile in 3 colori, in versione mono e doppia emissione e con due temperature di colore (3000K e 4000K).

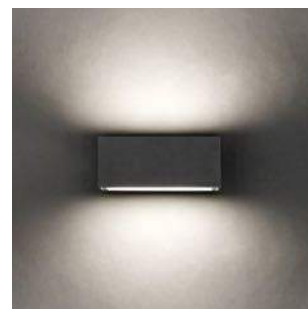
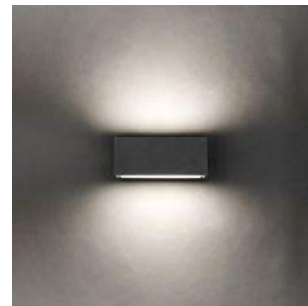

Smart

Die Afrodita-LED-Familie verfügt über die integrierte Casambi Bluetooth Mesh-Technologie, die eine konventionelle elektrische Installation ermöglicht.

La famiglia Afrodita LED dispone di tecnologia integrata Casambi Bluetooth Mesh, permettendo un'installazione elettrica convenzionale.

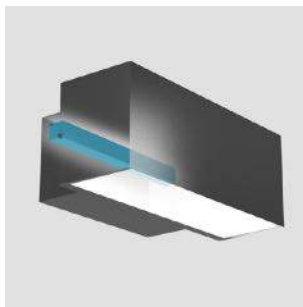

Notfall-Version Versione emergenza

Die Kollektion beinhaltet eine Notfall-Version mit eingebauter Technologie.

La collezione dispone di una versione di emergenza con tecnologia incorporata.



**Smart-Funktionen:
Lichtatmosphären**
Funzionalità Smart: Atmosfere
luminose

Mit Hilfe der Smart -Technologie bietet Afrodita eine große Vielseitigkeit bei den Anschlussmöglichkeiten, die die Programmierung verschiedener Lichtszenen je nach Zeitpunkt ermöglicht. Grazie alla sua tecnologia Smart, Afrodita offre un'ampia versatilità nelle opzioni di connettività, consentendo la programmazione di diverse scene luminose a seconda delle esigenze orarie.

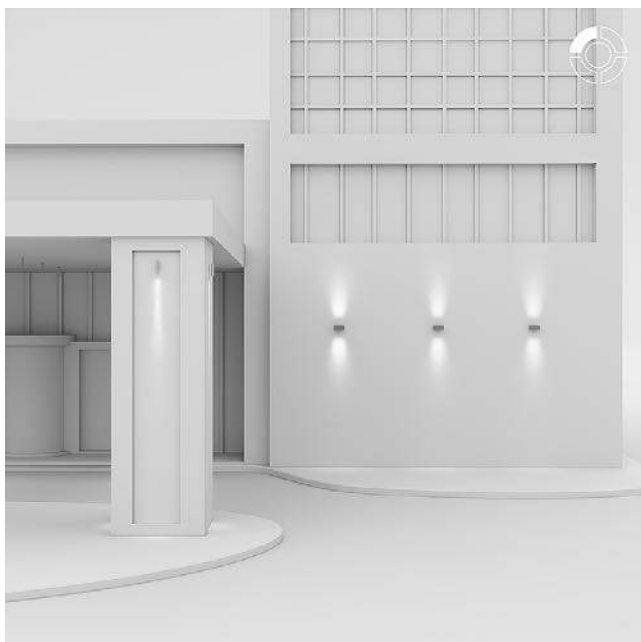

AFRODITA GU10



Bei dieser Wandleuchte handelt es sich um die GU10-Option aus der Afrodita-Kollektion, die in drei Farben, mit Einfach- und Doppelstrahler erhältlich ist.

Questa applique è la versione GU10 della collezione Afrodita, disponibile in 3 colori, a mono e doppia emissione.



AFRODITA POWER LED



Afrodita Power LED verfügt über einen Einfach- und einen Doppelstrahler.

Afrodita Power LED dispone di mono e doppia emissione.

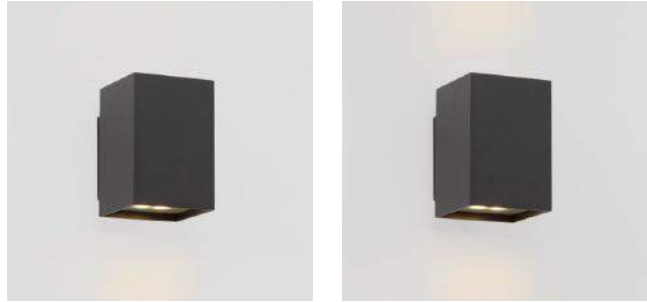

The Colours-Ausführungen Finiture The Colours

Afrodita Power LED ist in allen The Colours-Ausführungen aus dem LEDES C4-Katalog erhältlich.

Afrodita Power LED è disponibile in tutte le finiture The Colours del catalogo LEDES C4.



AFRODITA TECH

Aphrodite Tech ist in zwei Größen und zwei Farbtemperaturen erhältlich und lässt sich zur Kombination verschiedener Lichteffekte anpassen.

Afrodite Tech è disponibile in 2 misure, 2 temperature di colore e può adattarsi alla combinazione di diversi effetti di luce.

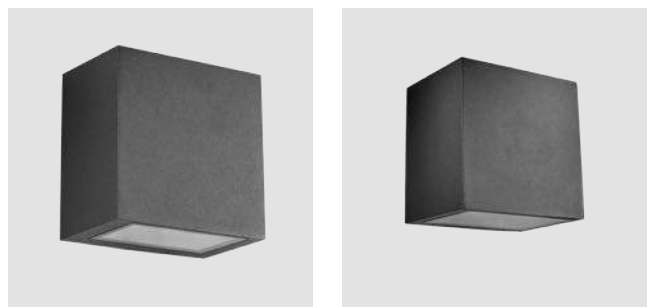

Modulzubehör Accessori modulanti

Die Kollektion bietet eine Einfach und eine Doppelstrahlervariante sowie verschiedenes Zubehör, mit dem sich eine Reihe von Lichteffekten schaffen lässt.

La collezione dispone dell'opzione doppia e mono-emissione e di vari accessori che permettono diversi effetti di luce.



Doppelstrahlervariante im größeren Format
Versione doppia emissione
misura grande



Zubehör nicht inbegriffen
Accessorio non incluso

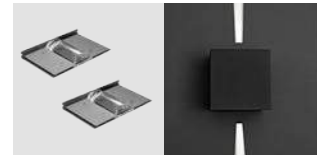

Zubehör nicht inbegriffen
Accessorio non incluso



Einfachstrahlervariante im größeren Format
Versione mono emissione
misura grande

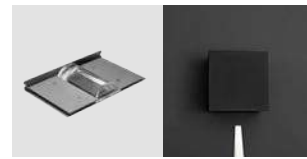

Zubehör nicht inbegriffen
Accessorio non incluso



Doppelstrahlervariante im kleineren Format
Versione doppia emissione
misura piccola



Zubehör inbegriffen
Accessorio incluso



Zubehör inbegriffen
Accessorio incluso



Einfachstrahlervariante im kleineren Format
Versione mono emissione
misura piccola



Zubehör inbegriffen
Accessorio incluso

AFRODITA

Afrodita Infinite

IP 66	IK 04	50000h L80 B20	3 MacAdam	LOW FLICKER		BREEAM	
----------	----------	-------------------	--------------	----------------	--	--------	--

14 Z5

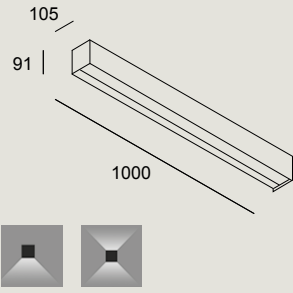

LED						
K	CRI	W LED	W Total	Real Lm	Optics	Code
3000	80	20.3	24.8	1388	Flood 90°	05-E084 - ¹⁴ Z5 - CL
3000	80	29	32.5	2083	Flood 90°	05-E052 - Z5 - CL
3000	80	29	32.5	2083	Flood 90°	05-E086 - ¹⁴ Z5 - CL
4000	80	20.3	24.8	1388	Flood 90°	05-E084 - ¹⁴ Z5 - CM
4000	80	29	32.5	2166	Flood 90°	05-E086 - Z5 - CM

	05-E052	DALI-2	100-240V	50-60Hz
	05-E084	0-10V	100-240V	50-60Hz
	05-E086	Casambi	220-240V	50-60Hz

AFRODITA

Afrodita LED Single emission

IP 65	IK 04	50000h L80 B20	3 MacAdam	SEA SIDE SUITABLE	ON-OFF	BREEAM
----------	----------	-------------------	--------------	----------------------	--------	--------

14 34 Z5

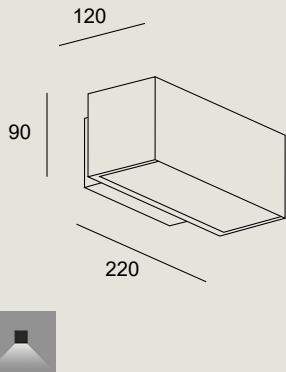

LED						
K	CRI	W LED	W Total	Real Lm	Optics	Code
3000	80	11.5	12.7	913	Flood 90°	¹⁴ 05-9912 - ³⁴ Z5 - CL
4000	80	11.5	12.7	1004	Flood 90°	05-9912 - Z5 - CM

	100-240V	50-60Hz
--	----------	---------

IP 66	IK 04	50000h L80 B20	3 MacAdam	SEA SIDE SUITABLE	BREEAM	
----------	----------	-------------------	--------------	----------------------	--------	--

14 34 Z5

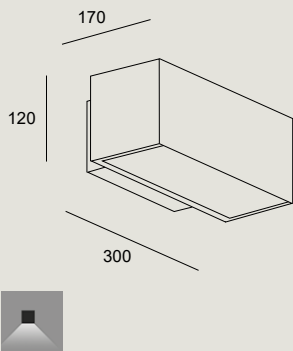

LED						
K	CRI	W LED	W Total	Real Lm	Optics	Code
3000	80	19	20.8	1670	Flood 88°	05-9879 ¹⁴
3000	80	19	20.8	1949	Flood 88°	05-E020 - ³⁴ Z5 - CL
3000	80	19	20.8	1949	Flood 88°	05-E047 Z5
4000	80	19	20.8	1837	Flood 88°	05-9879
4000	80	19	20.8	2144	Flood 88°	05-E020 - Z5 - CM
4000	80	19	20.8	2144	Flood 88°	05-E047

	05-9879	ON-OFF	100-240V	50-60Hz
	05-E020	Casambi	100-240V	50-60Hz
	05-E047	1-10V/PUSH/DALI	100-240V	50-60Hz

AFRODITA

Afrodita LED Double emission

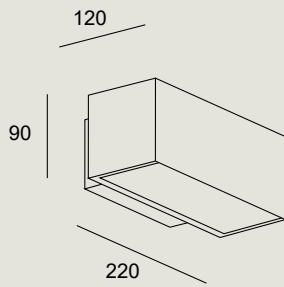

IP 65	IK 04	50000h L80 B20	3 MacAdam	SEA SIDE SUITABLE	ON-OFF	BREEAM
----------	----------	-------------------	--------------	----------------------	--------	--------

14 34 Z5

LED						
K	CRI	W LED	W Total	Real Lm	Optics	Code
3000	80	17.5	17.9	1494	Flood 88°	05-9911 - 34 - CL Z5
4000	80	17.5	17.9	1644	Flood 88°	05-9911 - Z5 - CM
100-240V 50-60Hz						

IP 66	IK 04	50000h L80 B20	3 MacAdam	SEA SIDE SUITABLE	BREEAM	
----------	----------	-------------------	--------------	----------------------	--------	--

14 34 Z5

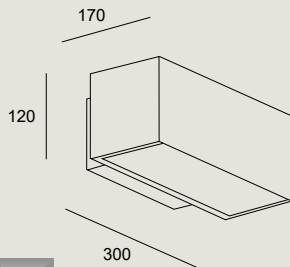

LED						
K	CRI	W LED	W Total	Real Lm	Optics	Code
3000	80	39	43.3	3288	Flood 88°	05-9878 14
3000	80	39	43.3	3069	Flood 88°	05-E021 - 34 - CL
3000	80	39	43.3	3069	Flood 88°	05-E048 Z5
4000	80	39	43.3	3617	Flood 88°	05-9878
4000	80	39	43.3	3376	Flood 88°	05-E021 - Z5 - CM
4000	80	39	43.3	3376	Flood 88°	05-E048
05-9878 ON-OFF 100-240V 50-60Hz 05-E021 Casambi 220-240V 50-60Hz 05-E048 DALI-2 220-240V 50-60Hz						

AFRODITA

Afrodita LED Emergency

IP	IK	50000h	3	SEA SIDE		BREEAM
66	04	L80 B20	MacAdam	SUITABLE	ON-OFF	

Z5 ●

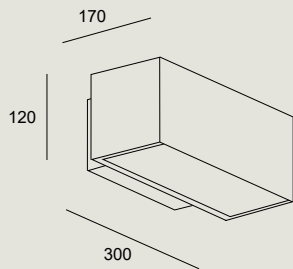

LED K:3000 CRI:80 BATTERY:NiCd							
W	Real Lm	Real Lm. Em	Optics	H. emergency	Perma- nent	Auto test	Code
19	1670	557	Flood 88°	1	Yes	No	05-8764 - Z5 - OE
19	1670	557	Flood 88°	3	Yes	No	
220-240V		50-60Hz					

LED K:4000 CRI:80 BATTERY:NiCd							
W	Real Lm	Real Lm. Em	Optics	H. emergency	Perma- nent	Auto test	Code
19	1837	612	Flood 88°	1	Yes	No	05-8766 - Z5 - OE
19	1837	612	Flood 88°	3	Yes	No	
220-240V		50-60Hz					

AFRODITA

Afrodita GU10 Single emission

	IP	IK	SEA SIDE
	65	10	SUITABLE

14 ○ 34 ● Z5 ●

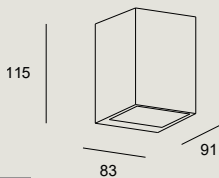

GU10	
W	Code
max. 8	14 05-E054 - 34 - 37 Z5

AFRODITA

Afrodita GU10 Double emission

IP	IK	SEA SIDE
55	06	SUITABLE

14 ○ 34 ● Z5 ●

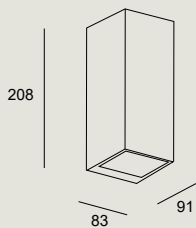

GU10	
W	Code
2 x max.8	14 05-9919 - 34 - 37 Z5

AFRODITA

Afrodita Power LED Single emission

NEW	IP 65	IK 10	50000h L80 B20	3 MacAdam	LOW FLICKER	SEA SIDE SUITABLE	ON-OFF	BREEM
------------	----------	----------	-------------------	--------------	----------------	----------------------	--------	-------

14* 34* 60* DL* E3* J6* Z5

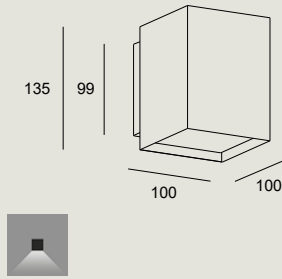

LED						
K	CRI	W LED	W Total	Real Lm	Optics	Code
3000	80	10.5	13	1136	Medium 26°	14
						34
						60
						05-E056 - DL - CL
						E3
4000	80	10.5	13	1136	Medium 26°	J6
						Z5
						14
						34
						60
4000	80	10.5	13	1136	Medium 26°	05-E056 - DL - CM
						E3
						J6
						Z5
						Z5

100-240V 50-60Hz

AFRODITA

Afrodita Power LED Double emission

IP 55	IK 04	50000h L80 B20	3 MacAdam	SEA SIDE SUITABLE	ON-OFF
----------	----------	-------------------	--------------	----------------------	--------

14* 34* 60* DL* E3* J6* Z5

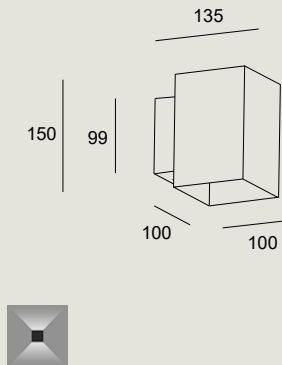

LED						
K	CRI	W LED	W Total	Real Lm	Optics	Code
3000	80	17.4	21.6	1324	Medium 22°	14
						34
						60
						05-9773 - DL - 37
						E3
4000	80	17.4	21.6	1390	Medium 22°	J6
						Z5
						14
						34
						60
4000	80	17.4	21.6	1390	Medium 22°	05-9773 - DL - CM
						E3
						J6
						Z5
						Z5

100-240V 50-60Hz

*Fragen Sie unser Verkaufsteam nach den Lieferbedingungen.

Consultare i termini e le condizioni di consegna al nostro team commerciale.

AFRODITA

Afrodita Tech Single emission

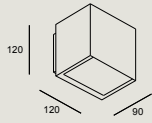

IP	IK	50000h	3	SEA SIDE	
65	05	L80 B20	MacAdam	SUITABLE	ON-OFF

Z5 ●

LED						
K	CRI	W LED	W Total	Real Lm	Optics	Code
3000	80	6	7.1	180	Flood 68°	05-E081 - Z5 - CL
4000	80	6	7.1	180	Flood 68°	05-E081 - Z5 - CM
100-277V		50-60Hz				

inklusive / Incluso

Zubehör zur Erzeugung eines schmalen Lichtstrahls
Accessorio per creare un fascio di luce stretto

IP	IK	50000h	2		SEA SIDE	
66	07	L80 B20	MacAdam		SUITABLE	0-10V

Z5 ●

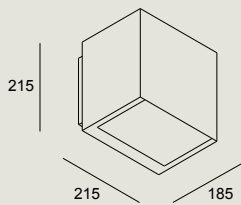

LED						
K	CRI	W LED	W Total	Real Lm	Optics	Code
3000	80	19.3	22.3	721	Flood 63°	05-E079 - Z5 - CL
4000	80	19.3	22.3	721	Flood 63°	05-E079 - Z5 - CM
100-240V		50-60Hz				

nicht inklusive / Non incluso

Lupe für engen Strahl
Lente per fascio di luce stretto

71-E078-Z5-00

AFRODITA

Afrodita Tech Double emission

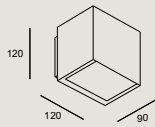

IP	IK	50000h	3	SEA SIDE	
65	05	L80 B20	MacAdam	SUITABLE	ON-OFF

Z5 ●

LED						
K	CRI	W LED	W Total	Real Lm	Optics	Code
3000	80	12	13.9	360	Flood 68°	05-E080 - Z5 - CL
4000	80	12	13.9	360	Flood 68°	05-E080 - Z5 - CM
100-277V		50-60Hz				

inklusive / Incluso

Zubehör zur Erzeugung eines schmalen Lichtstrahls (zwei Stück)
 Accessorio per creare un fascio di luce stretto (doppio)

IP	IK	50000h	2		SEA SIDE	
66	07	L80 B20	MacAdam		SUITABLE	0-10V

Z5 ●

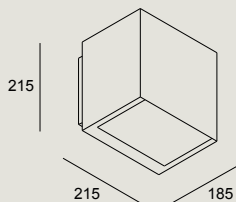

LED						
K	CRI	W LED	W Total	Real Lm	Optics	Code
3000	80	37.8	43.7	1441	Flood 63°	05-E078 - Z5 - CL
4000	80	37.8	43.7	1441	Flood 63°	05-E078 - Z5 - CM
100-240V		50-60Hz				

nicht inklusive / Non incluso

Lupe für engen Strahl
 Lente per fascio di luce stretto

71-E078-Z5-00

Nemesis

BODY MAT	DIF MAT
AL	GLA



Kollektion aus uni- und bidirektionalen Wandleuchten mit minimalistischem und elegantem Design, die in zwei Größen und vier verschiedenen Finishes erhältlich ist und sich somit für jedes Projekt eignet.

Collezione di applique a doppia e mono emissione con un design elegante e minimalista che si presenta in due misure ed in 4 diverse finiture, per adattarsi ad ogni tipo di progetto.

Lichteffekt Effetto di luce

Mit drei Farbtemperaturen und mit zwei- und einstrahliger Option erhältlich.

Con 3 temperature di colore, è disponibile nelle opzioni di doppia e mono emissione.



CCT-Technologie Tecnologia CCT

Mit eingebautem Schalter, der die Änderung der Farbtemperatur und die Umstellung zwischen uni- und bidirektionaler Lichtrichtung an einem Artikel ermöglicht.

Dispone di uno switch integrato che permette di variare la temperatura di colore e la posizione di doppia o mono emissione, partendo da un unico codice di riferimento.

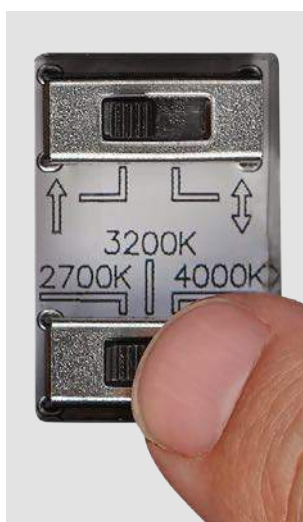

NEMESIS

IP	IK	SEA SIDE
44	06	SUITABLE

14 34 J6 Z5

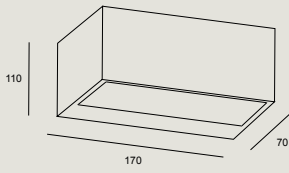

R7S		
W	W Total	Code
100	100	05-9177 - 14 34 - B8 J6 Z5

inklusive / Incluso

Lichtabdeckung zur Umrüstung von doppelter Abstrahlung auf einfache Abstrahlung
Otturatore di luce per passare da doppia emissione a singola emissione

IP	IK	SEA SIDE
54	04	SUITABLE

14 34 J6 Z5

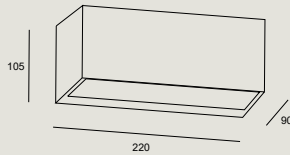

E27		
W	W Total	Code
60	60	05-9649 - 14 34 - T2 J6 Z5

inklusive / Incluso

Lichtabdeckung zur Umrüstung von doppelter Abstrahlung auf einfache Abstrahlung
Otturatore di luce per passare da doppia emissione a singola emissione

IP	IK	50000h	3	SEA SIDE		BREEAM	SWITCH CCT
65	06	L80 B20	MacAdam	SUITABLE	ON-OFF		SW 2700-3200-4000

14 34 J6 Z5

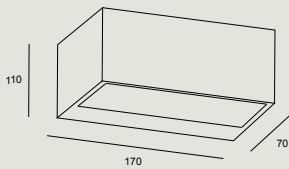

LED						
K	CRI	W LED	W Total	Real Lm	Code	
SW 2700-3200-4000	80	10.5	12.6	834	05-E026 -	14 34 - EH J6 Z5
100-240V		50-60Hz				

IP	IK	50000h	3	LOW	SEA SIDE		BREEAM	SWITCH CCT
65	04	L80 B20	MacAdam	FLICKER	SUITABLE	ON-OFF		SW 2700-3200-4000

14 34 J6 Z5

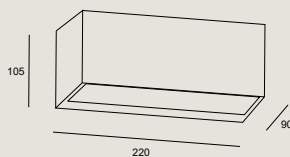

LED						
K	CRI	W LED	W Total	Real Lm	Code	
SW 2700-3200-4000	80	17.5	21	1816	05-E027 -	14 34 - EH J6 Z5
100-240V		50-60Hz				

Wilson

BODY MAT	DIF MAT		50000h	3
AL	GLA		L80 B20	MacAdam

Wandleuchtenkollektion in quadratischen und rechteckigen Formen, die sich besonders gut in den Raum integrieren lassen, da ihre Umrisslinie eine gepflegte Ästhetik ohne sichtbare Schrauben aufweisen. Alle Ausführungen weisen einen Doppelstrahler auf, wobei bei der quadratischen Version der Lichtstrahl dank der Möglichkeit, die inneren Flügel manuell zu verstellen, moduliert werden kann.

Collezione di applique con forma quadrata e rettangolare, appositamente studiate per integrarsi nello spazio, presentando un'estetica pulita e senza viti a vista. Tutte le versioni sono a doppia emissione; quella quadrata permette di modulare il fascio luminoso grazie alla possibilità di regolare, manualmente, le alette interne.



Öffnungswinkel Angoli di apertura

Der Lichtaustrittswinkel kann je nach den räumlichen Gegebenheiten schnell und einfach verändert werden.

Offre la possibilità di modificare l'angolo di emissione luminosa in base alle esigenze dello spazio, in modo semplice e veloce.



Hohe Anpassungsfähigkeit Grande adattabilità

Mit den Schutzklassen IP65 und IK08 eignet sich es sich sowohl für den privaten als auch den öffentlichen Bereich. Darüber hinaus gibt es 2 Farbtemperaturen (2700 K und 3000 K) und verschiedene Ausführungen, um sich an jede Umgebung oder jedes Beleuchtungskonzept anzupassen.

Progettato con un IP65 e un IK8, rendendolo adatto sia ad ambienti residenziali che pubblici. È, inoltre, disponibile in 2 temperature di colore (2700K e 3000K) e in varie finiture per adattarsi a qualsiasi ambiente o concetto di illuminazione.

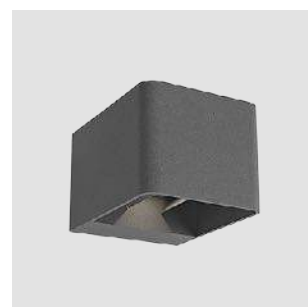

WILSON

IP	IK	SEA SIDE		BREEAM
65	08	SUITABLE	ON-OFF	

14 J6 Z5

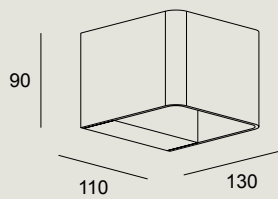

LED						
K	CRI	W LED	W Total	Real Lm	Code	
2700	80	9	10.2	623	05-9683 - Z5 - CK	
3000	80	9	10.2	623	14	05-9683 - J6 - CL
					Z5	
100-240V		50-60Hz				

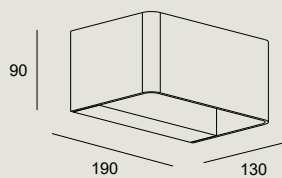

Z5

LED						
K	CRI	W LED	W Total	Real Lm	Code	
3000	80	18	20.7	916	05-9684 - Z5 - CL	
100-240V		50-60Hz				

Clous

BODY MAT	DIF MAT		50000h	3
AL	GLA		L80 B20	MacAdam



IP	IK	SEA SIDE	
66	03	SUITABLE	ON-OFF

14 ○ Z5 ●

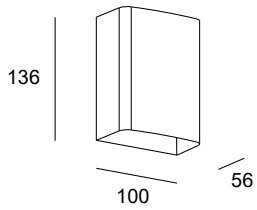

LED						
K	CRI	W LED	W Total	Real Lm	Optics	Code
3000	80	9	11	537	Flood 90°	05-9926 - 14 - Z5 - CL
100-240V		50-60Hz				



IP	IK	SEA SIDE		BREEAM
66	03	SUITABLE	ON-OFF	

14 ○ Z5 ●

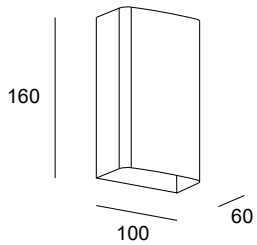

LED						
K	CRI	W LED	W Total	Real Lm	Optics	Code
3000	80	11	13	758	Flood 86°	05-9679 - 14 - Z5 - CL
100-240V		50-60Hz				



Cubus

BODY MAT	DIF MAT		50000h	3
AL	GLA		L80 B20	MacAdam

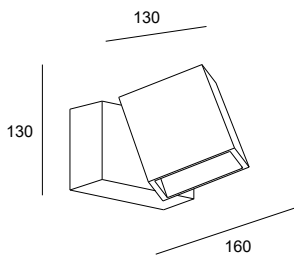

Z5 ●

LED						
K	CRI	W LED	W Total	Real Lm	Optics	Code
3000	80	11	13	701	Flood 71°	05-9685 - Z5 - CL
 100-240V		50-60Hz				



Finestra

BODY MAT	DIF MAT		50000h	3
AL	PC		L80 B20	MacAdam

Die Wandleuchtenkollektion Finestra wird auf Fenstersimsen angebracht, um Fassaden zu verschönern und in neuem Licht erscheinen zu lassen. Die Profi-Version verfügt über eine integrierte DMX-Steuerung, mit der wechselndes Licht auf ein ganzes Gebäude projiziert werden kann, wobei die Bedienung über eine einzige Konsole mit Fernsteuerung erfolgt. Dank einer Spezialbehandlung kann die Leuchte in feuchten Umgebungen oder sogar direkt am Meer installiert werden.

Finestra è una collezione di applique che vengono posizionate sulle cornici delle finestre per decorare e trasformare le facciate. La sua versione più professionale dispone di un controller DMX integrato che consente di proiettare una luce mutevole in un edificio e può essere controllata da una singola console remota. La struttura di questo prodotto prevede un trattamento speciale che permette la sua installazione in ambienti umidi o, addirittura, sul lungomare.



Farbfilter Filtri di colore

Die Standardversion verfügt über austauschbare Filter in Blau, Grün, Rot und Gelb.

La versione Standard dispone di filtri colorati intercambiabili, blu, verde, rosso e giallo.



Einfache Installation und Steuerung Installazione e regolazione facili



Die Ausstattung soll den Wechsel des Diffusors erleichtern und die Neigung der Leuchte regulieren.

Il suo equipaggiamento è stato studiato per facilitare il cambio del diffusore e regolare l'inclinazione dell'apparecchio.

Smart-Funktionen: Farbmanagement Funzionalità Smart: Gestione del colore

In der DMX-Version bietet die Leuchte Finestra mit dem entsprechenden Smart-Zubehör die Möglichkeit, die Lichtfarbe an Fenstern und Fassaden aus der Ferne zu steuern. Dies verleiht dem Raum eine unvergleichliche Flexibilität und bringt Dynamik und Vielseitigkeit in das Gebäude.

La versione DMX di Finestra, con il relativo accessorio Smart, offre la possibilità di gestire da remoto il colore della luce su finestre e facciate. Ciò conferisce allo spazio una funzionalità incomparabile grazie alla possibilità di creare e trasmettere dinamismo e versatilità all'edificio.

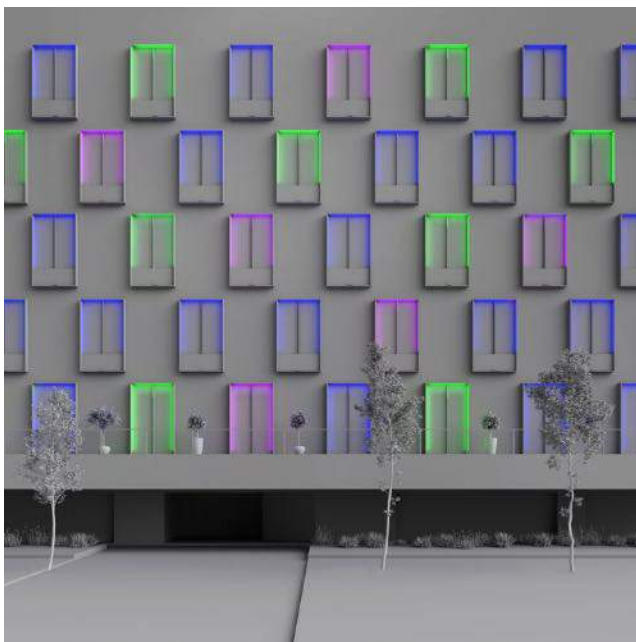

FINESTRA

Finestra RGBW DMX

IP 66	IK 10	LOW FLICKER		SEA SIDE SUITABLE			RGB LIGHT
----------	----------	----------------	--	----------------------	--	--	--------------

34

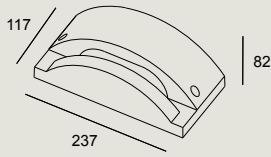

LED						
K	CRI	W LED	W Total	Real Lm	Optics	Code
RGBW DMX	80	8	10.8	414	Flood 44°	10-E077 - 34 - 00
100-277V		50-60Hz				

inklusive / Incluso
Diffusor-Filter Filtro diffusore

Smart Compatible-Zub. / Access. Smart Compatibile
71-A238-00-00 Converter Casambi DMX IP66

FINESTRA

Finestra Standard

IP 66	IK 10	1.5 m		SEA SIDE SUITABLE		BREEAM
----------	----------	-------	--	----------------------	--	--------

34



LED						
K	CRI	W LED	W Total	Real Lm	Optics	Code
4000	80	4.2	5.4	281	Flood 56°	10-9903 - 34 - CM
100-240V		50-60Hz				

inklusive / Incluso
Austauschbare farbige Filter Filtri intercambiabili colorati
3000-K-Diffusor Diffusore 3000K



Moal

BODY MAT	DIF MAT		50000h	3
AL,CON	PMMA		L80 B20	MacAdam



Eine Leuchte mit Charakter Personalità propria

Moal ist ein Outdoor-Sortiment mit modernem und zeitlosem Design aus Zement. Es eignet sich perfekt, um Kompositionen zu schaffen und einen Raum auf ansprechende und einladende Weise zu beleuchten. Die Kollektion besteht aus einer Wandleuchte und zwei Bodenleuchten, die sogar als Möbelstücke verwendet werden können. Moal erzeugt mit seiner Präsenz und einem Spiel aus Licht und Schatten Kompositionen, die sich insbesondere für Terrassen und Gärten von Hotels eignen. Moal è una collezione outdoor con un design contemporaneo e duraturo nel tempo, realizzata in cemento. È ideale per creare composizioni ed illuminare uno spazio in modo suggestivo e caldo. Si compone di una lampada da parete e due faretto che possono essere utilizzati anche come mobili da esterno. Concepito appositamente per essere collocato su terrazze e giardini di hotel, ristoranti o residenze, Moal crea composizioni con la sua presenza ed il suo gioco di luci ed ombre.

Die Wandleuchte enthält ein Zubehörteil zum Anheben, mit dem mehrere Wandleuchten übereinander geschoben werden können, so dass eine äußerst ansprechende und elegante Licht- und Schattenwirkung entsteht, die ein Qualitätsplus für Fassaden bietet.

L'applique comprende un accessorio di sollevamento per poter sovrapporre, tra loro, più applique e creare un effetto di luci ed ombre molto suggestivo ed elegante, fornendo un plus di qualità sulle facciate.

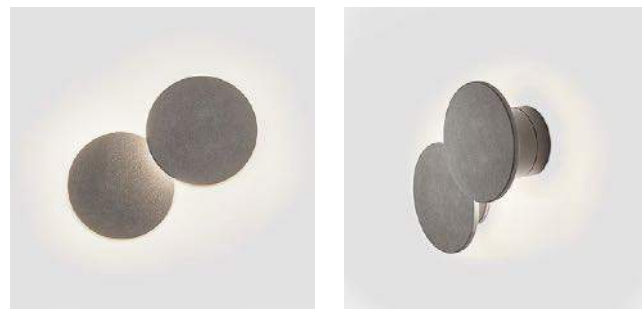

Hoher visueller Komfort Alto comfort visivo

Entwickelt, um dank der Platzierung der LED und der Neigung des Diffusors einen hohen visuellen Komfort zu bieten. Progettato per offrire un grande comfort visivo, grazie al posizionamento dei LED e all'inclinazione del diffusore.



Maximale Lebensdauer
Massima durabilità

Mit einem zu 100 % aus Zement gefertigtem Gehäuse, das die Lebensdauer des Produkts maximiert und seine Installation in nassen Umgebungen oder sogar direkt am Meer ermöglicht. Fabbricato al 100% in cemento per massimizzare la vita utile del prodotto e permettere la sua installazione in ambienti umidi o anche sul lungomare.



Einfache Installierung
Installazione facile

Doppelter Kabeleingang, um die Installation in Reihe zu vereinfachen.
Include un doppio ingresso dei cavi, per favorire l'installazione a catena.





MOAL

Moal Wall Fixture

IP	IK	LOW		SEA SIDE	
66	10	FLICKER		SUITABLE	ON-OFF

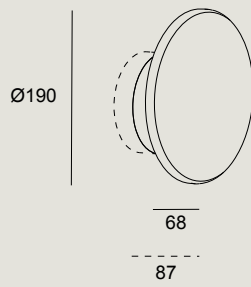
DC 



LED					
K	CRI	W LED	W Total	Real Lm	Code
3000	80	8.2	11.1	312	05-E087 - DC - CL
					
100-240V	50-60Hz				

inklusive / Incluso

Anheber zum Übereinanderschichten von Leuchten
Dispositivo per unire le luci e allungarle

Arc

BODY MAT	DIF MAT		50000h	3
AL,CON	GLA		L80 B20	MacAdam



Höchster Komfort Massimo comfort

Die Wandleuchte Arc konsolidiert das Angebot an Outdoor-Produkten aus Zement. Auf der Suche nach Produkten, die sich bestmöglich in die Architektur integrieren, wurde diese Wandleuchte entwickelt, welche in Wände oder Oberflächen eingelassen werden kann und dank des ausgeklügelten Designs und einer rechteckigen, sehr flachen Struktur praktisch mit der Umgebung verschmilzt. Arc wurde entwickelt, um Gänge zu beleuchten und das Hauptaugenmerk auf Licht und Raum zu lenken.

La lampada da parete Arc consolida la proposta di un prodotto da esterno, in cemento. Alla ricerca di materializzare prodotti che siano completamente integrati nell'architettura, questa applique può essere installata ad incasso nella parete o in superficie; permette, inoltre, mantenere un'ottima integrazione nell'ambiente avendo un design lavorato ed una struttura rettangolare, molto poco profonda. Arc è concepito per illuminare le zone di transito, lasciando tutto il risalto alla luce e allo spazio.

Der optische Lichtaustritt von Arc ist nach unten geneigt, um einen Durchgangsbereich genau dort, wo der maximale Lichtstrom benötigt wird, blendfrei auszuleuchten.

Il blocco ottico di Arc è orientato verso il basso per illuminare una zona di transito senza abbagliare, posizionato esattamente in modo che la massima emissione luminosa sia diretta dove è necessario e massimizzando il comfort visivo.



Maximum durability Durabilità maximale

Durch die Zusammensetzung aus Beton ist eine Installation in feuchten Umgebungen oder sogar direkt am Meer möglich. Grazie alla sua composizione in cemento può essere installato in ambienti umidi o anche sul lungomare.

Einfache und schnelle Installation Installazione facile e rapida

Das LED-Modul lässt sich schnell installieren und im Falle eines Ausfalls leicht austauschen. Doppelter Kabelausgang, um die Installation in Reihe zu vereinfachen.

Installazione rapida del modulo LED, facilmente sostituibile, in caso di guasto. Include una doppia uscita del cavo, per facilitare l'installazione a catena.



ARC

IP	IK		SEA SIDE SUITABLE	
66	10			ON-OFF

DC

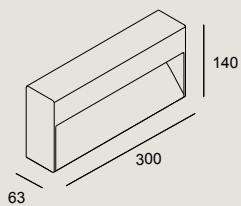

LED					
K	CRI	W LED	W Total	Real Lm	Code
3000	80	9	9	404	05-E090 - DC - CL 05-E091
4000	80	9	9	404	05-E090 - DC - CM

	Code	ON-OFF	Voltage	Frequency
05-E090	ON-OFF	230V	50-60Hz	
05-E091	ON-OFF	120V	60Hz	

nicht inklusive / Non incluso

Unterputzdose
Scatola da incasso

71-E090-Z5-00

Kössel

BODY MAT	DIF MAT		50000h	3
PC+ABS	PC		L80 B20	MacAdam

Diese Kollektion von Wandleuchten zur Installation in Meeresnähe zeichnet sich durch ihre einfache Installation aus. Die flache Struktur beinhaltet den Treiber und erzeugt einen Wandintegrationseffekt.

Questa collezione di applique adatte ad essere utilizzate in ambienti con atmosfera marina, si distinguono per la loro facile installazione. La loro struttura, poco profonda, incorpora il driver e crea un effetto di integrazione sulla parete.



Kössel Direkt und Indirekt Kössel direct e indirect

Die Kollektion Kössel ist in einer Version mit direktem Licht und einer anderen mit indirektem Licht erhältlich, wobei letztere verschiedene Formen und verschiedene LED-Positionen zur Ausrichtung des Lichtstrahls bietet.

La collezione Kössel è presentata in un formato a luce diretta e in un formato a luce indiretta; quest'ultima opzione, con diverse forme e diverse posizioni dei LED, permette dirigere il fascio luminoso.

Kössel direct



Kössel indirect



Farzubehör Accessorio di colore

Alle Optionen enthalten Zubehör zum Ändern der Farbe der Leuchte, das schnell und effektiv an die schwankenden Anforderungen jedes Projekts angepasst werden kann.

Ogni opzione disponibile include un accessorio per cambiare il colore della lampada e può essere adattato rapidamente ed efficacemente alle mutevoli esigenze di ogni progetto.



Einfache Installierung Installazione facile

Kössel weist eine flache Form mit integriertem Treiber auf, um die Installation zu erleichtern. Zudem verfügt sie über einen doppelten Kabelausgang.

Kössel ha una struttura poco profonda, pur incorporando il driver, per facilitare la sua installazione. Dispone, inoltre, di una doppia uscita del cavo.

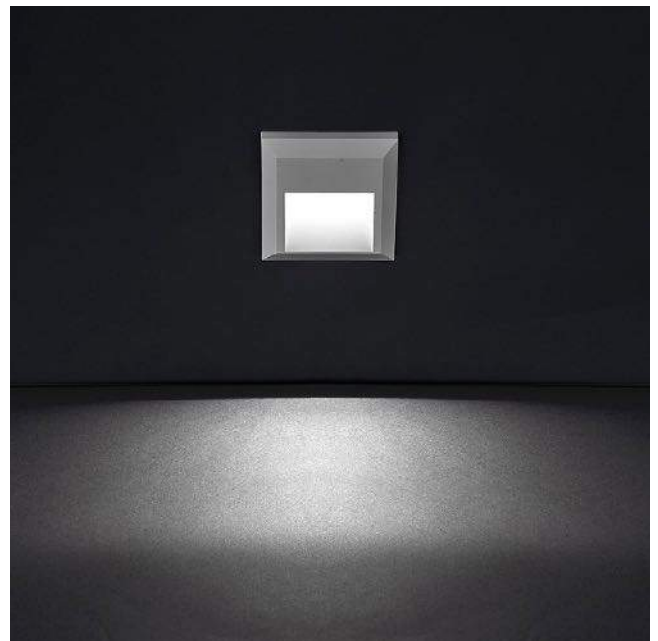

KÖSSEL

Kössel Wall Fixture Direct

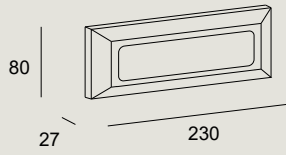

IP	IK		SEA SIDE	BREEAM
65	10		SUITABLE	

34

LED					
K	CRI	W LED	W Total	Real Lm	Code
3000	80	3.8	3.8	238	05-9779 - 34 - CL
4000	80	3.8	3.8	262	05-9779 - 34 - CM

100-240V 50-60Hz

inklusive / Incluso

Vorderkappe weiß
Mascherina bianca

Vorderkappe schwarz
Mascherina nera

Vorderkappe grau
Mascherina grigia

KÖSSEL

Kössel Wall Fixture Indirect

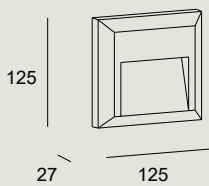

IP	IK	SEA SIDE
65	10	SUITABLE

14

LED					
K	CRI	W LED	W Total	Real Lm	Code
4000	80	1.5	1.5	65	05-9802 - 14 - CM

100-240V 50-60Hz

inklusive / Incluso

3000-K-Diffusor
Diffusore 3000K

Vorderkappe weiß
Mascherina bianca

Vorderkappe grau
Mascherina grigia

Vorderkappe schwarz
Mascherina nera

KÖSSEL

Kössel Wall Fixture Indirect

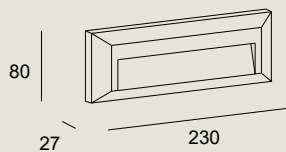

IP	IK		SEA SIDE
65	10		SUITABLE

14

LED					
K	CRI	W LED	W Total	Real Lm	Code
4000	80	2.4	2.4	91	05-9814 - 14 - CM
		100-240V 50-60Hz			

inklusive / Incluso

3000-K-Diffusor
Diffusore 3000K

Vorderkappe weiß
Mascherina bianca

Vorderkappe schwarz
Mascherina nera

Vorderkappe grau
Mascherina grigia

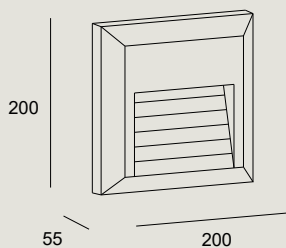

IP	IK		SEA SIDE	
66	10		SUITABLE	ON-OFF

14

LED					
K	CRI	W LED	W Total	Real Lm	Code
4000	80	6.4	7	295	05-E012 - 14 - CM
		100-240V 50-60Hz			

inklusive / Incluso

3000-K-Diffusor
Diffusore 3000K

Vorderkappe weiß
Mascherina bianca

Vorderkappe grau
Mascherina grigia

Vorderkappe schwarz
Mascherina nera



Modis

LUCA TURRINI 2022

BODY MAT	DIF MAT		50000h	3
AL	GLA		L80 B20	MacAdam

Modis ist ein neuer Vorschlag für den Außenbereich mit einer ausgeprägt dekorativen Komponente. Ein klares und neutrales Profil sowie eine Konstruktion, die eine hohe Beweglichkeit des Kugelgelenks erlaubt und die Möglichkeit bietet, die Abstrahlungsart zu wählen, denn die Leuchte ist wahlweise mit konzentriertem oder gebündeltem Licht erhältlich. Die vielköpfige Familie der Kollektion und ihre Kompositionsmöglichkeiten machen sie zu einer Lösung, die sich durch ihre Vielseitigkeit auszeichnet und sich meisterhaft und elegant an die Anforderungen von Projekten im Gesamtbild anpassen, die ein ästhetisches Gleichgewicht im Gesamtbild erfordern. Neben den dekorativen Vorzügen wurde auch den technischen Aspekten große Aufmerksamkeit gewidmet, um die Vielseitigkeit der Familie noch stärker zu betonen. Modis weist eine hohe Stoßfestigkeit (IK10), Staubdichtheit und Hochdruckwasserbeständigkeit (IP66) auf und kann dank der KTL-Grundierung auch in Umgebungen mit harter Seeluft aufgestellt werden.

Modis è una nuova proposta da esterno con una grande componente decorativa. Dal profilo pulito e neutro, il suo design si basa sulla grande capacità di movimento dello snodo e sulla possibilità di scegliere il fascio di luce, con opzione luce concentrata o diffusa. La grande famiglia della collezione e le sue possibilità compositive la trasformano in una scelta caratterizzata da versatilità e adattabile con maestria ed eleganza alle esigenze di progetti che richiedono insieme esteticamente equilibrati. Oltre al valore decorativo, gli aspetti tecnici sono stati curati fin nei minimi dettagli, per offrire una linea ancora più polivalente. Modis ha una grandissima resistenza agli urti (IK10), un'eccellente protezione dall'ingresso di polvere e acqua ad alta pressione (IP66) e può essere installata in ambienti con atmosfera marina, grazie al processo di verniciatura in cataforesi.

Beleuchtungsanlagen Sistemi di illuminazione

Alle Mitglieder der Modis-Familie sind mit zwei Innenmodulen erhältlich, bei denen je nach den Anforderungen der zu beleuchtenden Umgebung zwischen Opal- und Optics-Optik gewählt werden kann. Die Opal-Variante ist für die Grundbeleuchtung vorgesehen und mit der Optik-Option kann der Lichtschein zum Hervorheben von einzelnen Objekten oder Szenen gebündelt werden, wobei die Optiken Spot 18°, Medium 34° und Flood 48° zur Auswahl stehen. Darüber hinaus bietet die Optics-Variante einen hervorragenden visuellen Komfort (UGR<16) und eine hohe Lichtqualität (CRI90).

In tutta la famiglia Modis presenta due moduli interni a scelta tra ottica Opal e Optics, in base alle esigenze dell'ambiente da illuminare. La versione Opal offre un'illuminazione generale mentre l'opzione Optics consente di concentrare il fascio per mettere in risalto oggetti o scene concrete, con la possibilità di scegliere tra ottica Spot 18°, Medium 34° e Flood 48°. Inoltre, la versione Optics offre un grande comfort visivo (UGR<16) e una luce di qualità (CRI90).



Opal



Optics

MODIS

Modis Opal Wall Fixture/Spotlight/ Ceiling

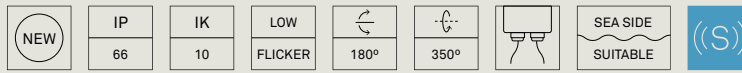

14* ○ 34* ● 60* ● DL* ● E3* ● J6* ● Z5 ●

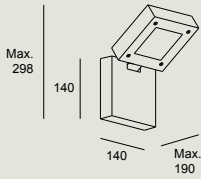

LED						
K	CRI	W LED	W Total	Real Lm	Code	
SW 2700-3200-4000	80	11.6	13.2	744	14	
					34	
					60	DU
					E3	DL - OU
					J6	XB
Z5						

XB	Casambi	220-240V	50-60Hz
DU	DALI-2	100-277V	50-60Hz
OU	ON-OFF	100-277V	50-60Hz



nicht inklusive / Non incluso	
Pflock 235 mm / Paletto 235mm	71-9997-05-05
Pflock 302mm / Paletto 302mm	71-9998-05-05



14* ○ 34* ● 60* ● DL* ● E3* ● J6* ● Z5 ●

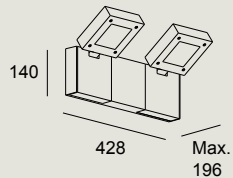

LED						
K	CRI	W LED	W Total	Real Lm	Code	
SW 2700-3200-4000	80	11.6	26.4	1488	14	
					34	
					60	DU
					E3	DL - OU
					J6	XB
Z5						

XB	Casambi	220-240V	50-60Hz
DU	DALI-2	100-277V	50-60Hz
OU	ON-OFF	100-277V	50-60Hz



nicht inklusive / Non incluso	
Verkettungszubehör Leuchtenkopf extra weiß / Access. extra di collegamento in serie testa bianco	71-E235-14-00
Verkettungszubehör Leuchtenkopf extra schwarz / Access. extra di collegamento in serie testa nero	71-E235-60-00
Verkettungszubehör Leuchtenkopf extra hellgrau / Access. extra di collegamento in serie testa grigio chiaro	71-E235-34-00
Verkettungszubehör Leuchtenkopf extra braun / Access. extra di collegamento in serie testa marrone	71-E235-J6-00
Verkettungszubehör Leuchtenkopf tannengrün / Access. extra di collegamento in serie testa verde abete	71-E235-E3-00
Verkettungszubehör Leuchtenkopf extra gold / Access. extra di collegamento in serie testa dorato	71-E235-DL-00
Verkettungszubehör Leuchtenkopf extra grau / Access. extra di collegamento in serie testa grigio	71-E235-Z5-00

MODIS

Modis Opal Wall Fixture/Spotlight/ Ceiling



IP	66
----	----

IK	10
----	----

LOW	FLICKER
-----	---------

180°

350°



SEA SIDE	SUITABLE
----------	----------

BREEAM

SWITCH CCT	SW 2700-3200-4000
------------	-------------------



14* 34* 60* DL* E3* J6* Z5

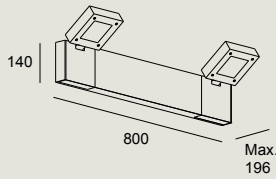

LED						
K	CRI	W LED	W Total	Real Lm	Code	
					14	
					34	
					60	DU
SW 2700-3200-4000	80	11.6	26.4	1488	05-E064 -	DL - OU XB
						J6
						Z5

XB	Casambi	220-240V	50-60Hz
DU	DALI-2	100-277V	50-60Hz
OU	ON-OFF	100-277V	50-60Hz



nicht inklusive / Non incluso		
Verkettungszubehör Leuchtenkopf extra weiß / Access. extra di collegamento in serie testa bianco		71-E235-14-00
Verkettungszubehör Leuchtenkopf extra schwarz / Access. extra di collegamento in serie testa nero		71-E235-60-00
Verkettungszubehör Leuchtenkopf extra hellgrau / Access. extra di collegamento in serie testa grigio chiaro		71-E235-34-00
Verkettungszubehör Leuchtenkopf extra braun / Access. extra di collegamento in serie testa marrone		71-E235-J6-00
Verkettungszubehör Leuchtenkopf tannengrün / Access. extra di collegamento in serie testa verde abete		71-E235-E3-00
Verkettungszubehör Leuchtenkopf extra gold / Access. extra di collegamento in serie testa dorato		71-E235-DL-00
Verkettungszubehör Leuchtenkopf extra grau / Access. extra di collegamento in serie testa grigio		71-E235-Z5-00

nicht mitgeliefertes allgemeines Zub. Access. comuni non inclusi		
Blende weiß Visiera bianca		71-E234-14-00
Blende hellgrau Visiera grigio chiaro		71-E234-34-00
Blende schwarz Visiera nera		71-E234-60-00
Blende gold Visiera dorata		71-E234-DL-00
Blende tannengrün Visiera verde abete		71-E234-E3-00
Blende braun Visiera marrone		71-E234-J6-00
Blende grau Visiera grigia		71-E234-Z5-00

*Fragen Sie unser Verkaufsteam nach den Lieferbedingungen.
Consultare i termini e le condizioni di consegna al nostro team commerciale.

MODIS

Modis Optics Wall Fixture/Spotlight/ Ceiling



Codebeispiel / Esempio di codice: AS11-18V9S3OUZ5

Model	W	K/ Cri/ Real lm	Optics	Source	Finishes
AS11 - 	18 18,3W	V9 2700K CRI90/1301 lm	S3 16°	OU ON-OFF 100-277V 50-60Hz	Z5
		W9 3000K CRI90/1301 lm	M3 33°	DS DALI-2 220-240V 50-60Hz	14* 60*
		X9 4000K CRI90/1301 lm	F1 48°	XB CASAMBI 220-240V 50-60Hz	34* J6* E3* DL*

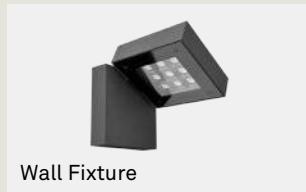

nicht inklusive / Non incluso

Pflock 235 mm / Paletto 235mm

71-9997-05-05

Pflock 302mm / Paletto 302mm

71-9998-05-05



Codebeispiel / Esempio di codice: AS12-37V9S3OUZ5

Model	W	K/ Cri/ Real lm	Optics	Source	Finishes
AS12 - 	37 36,6W	V9 2700K CRI90/2602 lm	S3 16°	OU ON-OFF 100-277V 50-60Hz	Z5
		W9 3000K CRI90/2602 lm	M3 33°	DS DALI-2 220-240V 50-60Hz	14* 60*
		X9 4000K CRI90/2602 lm	F1 48°	XB CASAMBI 220-240V 50-60Hz	34* J6* E3* DL*

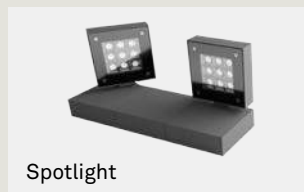

nicht inklusive / Non incluso

Verkettungszubehör Leuchtenkopf extra weiß / Access. extra di collegamento in serie testa bianco

71-E235-14-00

Verkettungszubehör Leuchtenkopf extra schwarz / Access. extra di collegamento in serie testa nero

71-E235-60-00

Verkettungszubehör Leuchtenkopf extra hellgrau / Access. extra di collegamento in serie testa grigio chiaro

71-E235-34-00

Verkettungszubehör Leuchtenkopf extra braun / Access. extra di collegamento in serie testa marrone

71-E235-J6-00

Verkettungszubehör Leuchtenkopf tannengrün / Access. extra di collegamento in serie testa verde abete

71-E235-E3-00

Verkettungszubehör Leuchtenkopf extra gold / Access. extra di collegamento in serie testa dorato

71-E235-DL-00

Verkettungszubehör Leuchtenkopf extra grau / Access. extra di collegamento in serie testa grigio

71-E235-Z5-00

*Fragen Sie unser Verkaufsteam nach den Lieferbedingungen.

Consultare i termini e le condizioni di consegna al nostro team commerciale.

MODIS

Modis Optics Wall Fixture/Spotlight/ Ceiling



Codebeispiel / Esempio di codice: AS13-37V9S30UZ5

Model	W	K/ Cri/ Real lm	Optics	Source	Finishes
AS13 - 	37 36,6W	V9 2700K CRI90/2602 lm	S3 16°	OU ON-OFF 100-277V 50-60Hz	Z5
		W9 3000K CRI90/2602 lm	M3 33°	DS DALI-2 220-240V 50-60Hz	14*
		X9 4000K CRI90/2602 lm	F1 48°	XB CASAMBI 220-240V 50-60Hz	60*
					34*
					J6*
					E3*
					DL*



nicht inklusive / Non incluso		
Verkettungszubehör Leuchtenkopf extra weiß / Access. extra di collegamento in serie testa bianco		71-E235-14-00
Verkettungszubehör Leuchtenkopf extra schwarz / Access. extra di collegamento in serie testa nero		71-E235-60-00
Verkettungszubehör Leuchtenkopf extra hellgrau / Access. extra di collegamento in serie testa grigio chiaro		71-E235-34-00
Verkettungszubehör Leuchtenkopf extra braun / Access. extra di collegamento in serie testa marrone		71-E235-J6-00
Verkettungszubehör Leuchtenkopf tannengrün / Access. extra di collegamento in serie testa verde abete		71-E235-E3-00
Verkettungszubehör Leuchtenkopf extra gold / Access. extra di collegamento in serie testa dorato		71-E235-DL-00
Verkettungszubehör Leuchtenkopf extra grau / Access. extra di collegamento in serie testa grigio		71-E235-Z5-00

nicht mitgeliefertes allgemeines Zub. Access. comuni non inclusi	Blende weiß Visiera bianca	71-E234-14-00
	Blende hellgrau Visiera grigio chiaro	71-E234-34-00
	Blende schwarz Visiera nera	71-E234-60-00
	Blende gold Visiera dorata	71-E234-DL-00
	Blende tannengrün Visiera verde abete	71-E234-E3-00
	Blende braun Visiera marrone	71-E234-J6-00
	Blende grau Visiera grigia	71-E234-Z5-00

*Fragen Sie unser Verkaufsteam nach den Lieferbedingungen.
Consultare i termini e le condizioni di consegna al nostro team commerciale.

Blade

BODY MAT	DIF MAT		50000h	3
AL	GLA		L80 B20	MacAdam



Hoher visueller Komfort Alto comfort visivo

Mit asymmetrischem Metallreflektor zur Optimierung der Lichtintensität und zur Gewährleistung einer perfekten optischen Kontrolle.

Include un riflettore metallico asimmetrico per ottimizzare il flusso luminoso e garantire un perfetto controllo ottico.



Maximale Lebensdauer Massima durabilità



Mit einem Gehäuse aus Aluminium, das einer besonderen Rostschutzbehandlung unterzogen wurde, die die Lebensdauer des Produkts maximiert und seine Installation in nassen Umgebungen oder sogar direkt am Meer ermöglicht. Besitzt zudem ein Ventil zur Ableitung des Kondenswassers, wodurch die Lebensdauer der Leuchte optimal verlängert wird.

Dotato di un corpo in alluminio che è stato lavorato con una speciale protezione dalla ruggine, per massimizzare la vita utile del prodotto, permette la sua installazione in ambienti umidi o anche sul lungomare. Include anche una valvola per evacuare la condensa e massimizzare, in questo modo, la durata dell'apparecchio.

Optimale Integration Integrazione ottima

Mit ultraflachem Design (<50 mm) für eine bessere Integration der Leuchte in die Architektur.

Presenta un design ultrapiatto (<50mm) per una miglior integrazione dell'apparecchio nell'architettura.



BLADE

IP 66	IK 10	±90°	1.5 m	SEA SIDE SUITABLE	ON-OFF	BREEAM
----------	----------	------	-------	----------------------	--------	--------

34

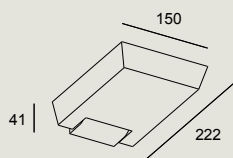

LED						
K	CRI	W LED	W Total	Real Lm	Optics	Code
3000	80	12	14.4	1170	Flood 55°	05-E106 - 34 - CL
4000	80	12	14.4	1170	Flood 55°	05-E106 - 34 - CM
100-277V		50-60Hz				

IP 66	IK 10	±90°	1.5 m	SEA SIDE SUITABLE	BREEAM	
----------	----------	------	-------	----------------------	--------	--

34

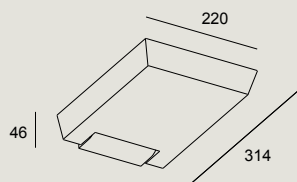

LED						
K	CRI	W LED	W Total	Real Lm	Optics	Code
3000	80	31.7	35.8	2764	Flood 79°	05-E107 - 34 - CL
4000	80	31.7	35.8	2764	Flood 79°	05-E107 - 34 - CM
05-E107	DALI-2	100-277V	50-60Hz			
05-E107	DALI	100-277V	50-60Hz			

Smart Compatible-Zub. / Access. Smart Compatibile
71-A237-00-00 Converter Casambi DALI IP66

nicht mitgeliefertes
allgemeines Zub.
Access. comuni non inclusi

IP68-Stecker mit 6 Eingängen Connettore IP68 a 6 ingressi	71-9199-05-05
IP67-Stecker mit 3 Eingängen Connettore IP67 a 3 ingressi	71-9262-05-05
Befestigungszubehör zur Montage am Mast oder Baum Fissaggio per colonne o alberi	71-9999-Z5-Z5
IP68- Antikondensationsstecker mit 2 Eingängen Connettore IP68 con valvola anticondensa a 2 ingressi	71-E112-00-00
IP68- Antikondensationsstecker mit 4 Eingängen Connettore IP68 con valvola anticondensa a 4 ingressi	71-E122-00-00



Skat

BODY MAT	DIF MAT		50000h	3
AL	PC		L80 B20	MacAdam



Skat ist eine Kollektion von Wandleuchten mit Direktbeleuchtung mit zeitlosem Design und vielseitigen Anwendungen. Sie ist in drei Baugrößen erhältlich und kann mit den von LEDS C4 angebotenen Farben individuell gestaltet werden. Diese Leuchte strahlt ein gleichmäßiges Licht ab und verfügt über die CCT-Technologie, d.h. die Farbtemperatur kann über einen Schalter gewählt werden.

Skat è una collezione di applique per illuminazione diretta, dal design senza tempo e con uso versatile. Disponibile in 3 misure e personalizzabile con i colori offerti da LEDS C4. Questo apparecchio proietta una luce omogenea ed include la tecnologia CCT, con la quale è possibile scegliere la temperatura del colore tramite un interruttore.

Vielseitigkeit Versatilità

Erhältlich in drei Größen (50 cm x 20 cm, 35 cm x 20 cm und 20 cm x 10 cm) mit verschiedenen Ausführungen, die eine Anpassung an verschiedene Stile und Inneneinrichtungen ermöglichen.

È disponibile in 3 misure, una da 50cm x 20cm, una da 35cm x 20 cm e un'altra da 20cm x 10cm, con diverse finiture che gli consentono di adattarsi a stili e arredamenti diversi.

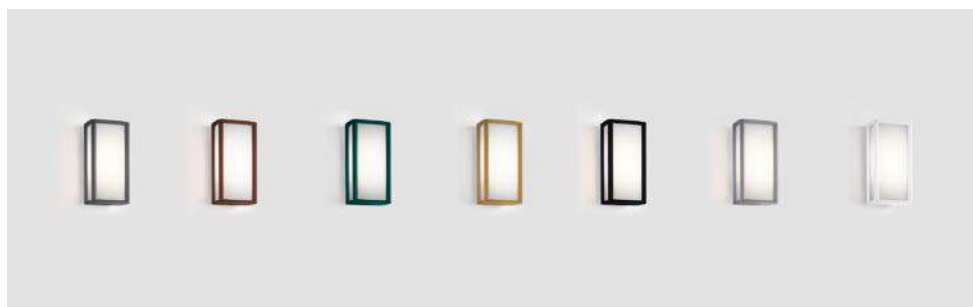
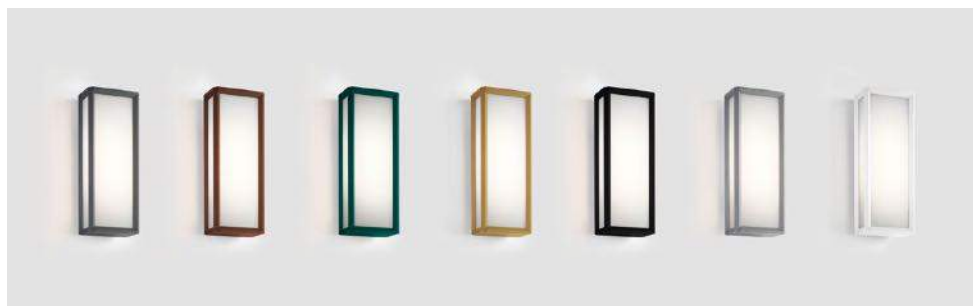

CCT-Technologie Tecnologia CCT

Mit integriertem Schalter zur Änderung der Farbtemperatur.
Lo switch integrato permette la variazione della temperatura di colore, partendo da un unico codice di riferimento.



2700K



3200K



4000K



Höchste Langlebigkeit und Widerstandsfähigkeit Massima durabilità e resistenza

Mit einem Gehäuse aus Aluminiumdruckguss und einem PMMA-Diffusor, die die Lebensdauer des Produkts maximieren und seine Installation in nassen Umgebungen oder sogar direkt am Meer ermöglichen.

Dotato di un corpo in alluminio iniettato e di un diffusore in PMMA per massimizzare la vita utile del prodotto; può essere installato in ambienti umidi o anche sul lungomare.



SKAT

IP	IK	SEA SIDE		BREEAM	SWITCH CCT
65	10	SUITABLE	ON-OFF		SW 2700-3200-4000

14* 34* 60* DL* E3* J6* Z5

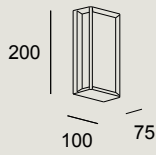

LED						
K	CRI	W LED	W Total	Real Lm	Code	
SW 2700-3200-4000	80	9	10	602	14	
					34	
					60	
					05-E028 - DL - EH	
					E3	
J6						
Z5						
 100-240V 50-60Hz						

NEW	IP	IK	LOW		SEA SIDE	BREEAM	SWITCH CCT	
	65	10	FLICKER		SUITABLE		SW 2700-3200-4000	ON-OFF

14* 34* 60* DL* E3* J6* Z5

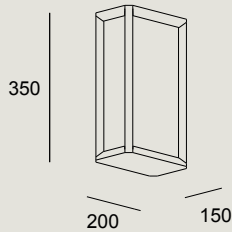

LED						
K	CRI	W LED	W Total	Real Lm	Code	
SW 2700-3200-4000	80	21.8	25.5	1266	14	
					34	
					60	
					05-E055 - DL - EH	
					E3	
J6						
Z5						
 100-240V 50-60Hz						

IP	IK	LOW		SEA SIDE		SWITCH CCT
65	10	FLICKER		SUITABLE	ON-OFF	SW 2700-3200-4000

14* 34* 60* DL* E3* J6* Z5

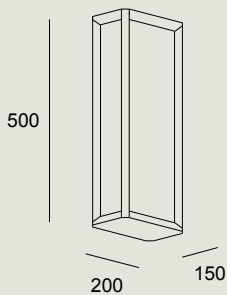

LED						
K	CRI	W LED	W Total	Real Lm	Code	
SW 2700-3200-4000	80	21.8	25.5	1266	14	
					34	
					60	
					05-E109 - DL - EH	
					E3	
J6						
Z5						
 100-240V 50-60Hz						

*Fragen Sie unser Verkaufsteam nach den Lieferbedingungen.

Consultare i termini e le condizioni di consegna al nostro team commerciale.

Mega

BODY MAT	DIF MAT		50000h	3
AL	PLABS		L80 B20	MacAdam



Großformatige Wandleuchten zur einheitlichen Ausleuchtung großer Räume wie Eingangsbereiche, Vordächer und Terrassen von Hotels, Einkaufszentren, Flughäfen und öffentlichen Räumen. Mega ist in zwei Größen mit 80 cm und 120 cm Durchmesser erhältlich und ist mit der CCT-Technologie ausgestattet, bei der Sie die Farbtemperatur über einen Schalter wählen können. Die Kollektion gibt ein einheitliches und komfortables Licht und enthält einen DALI-Treiber.

Applique di grandi dimensioni per illuminare, in modo omogeneo, grandi spazi come zone di ingresso, porticati e terrazze di hotel, centri commerciali, aeroporti e spazi pubblici. Mega è disponibile in due misure, 80 cm e 120 cm di diametro, e incorpora la tecnologia CCT, con la quale è possibile scegliere la temperatura di colore, tramite un interruttore. La collezione proietta una luce uniforme e confortevole ed include un driver DALI dimmerabile.

CCT-Technologie Tecnologia CCT

Der eingebaute Schalter ermöglicht die Änderung der Farbtemperatur ausgehend von einer einzelnen Artikels.



Lo switch integrato permette la variazione della temperatura di colore, partendo da un unico riferimento.

Höchste Langlebigkeit und Widerstandsfähigkeit Massima durabilità e resistenza

Mit einem Sockel aus Aluminiumdruckguss und einem im Rotationsgussverfahren hergestellten Polyethylen-Diffusor, die die Lebensdauer des Produkts maximieren und seine Installation in nassen Umgebungen oder sogar direkt am Meer ermöglichen. Dotato di una base in alluminio iniettato e di un diffusore in polietilene, realizzato con stampato rotazionale, per massimizzare la vita utile del prodotto e permettere la sua installazione, in ambienti umidi o anche sul lungomare.





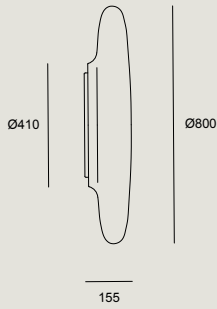

MEGA

IP 65	IK 10	UGR <16	LOW FLICKER		SEA SIDE SUITABLE		BREEAM	SWITCH CCT SW 3000-4000	
----------	----------	------------	----------------	--	----------------------	--	--------	----------------------------	--

M1 



LED					
K	CRI	W LED	W Total	Real Lm	Code
SW 3000-4000	80	74	76.8	8062	15-E110 - M1 - EH
 100-277V	50-60Hz				

IP 65	IK 10	UGR <13	LOW FLICKER		SEA SIDE SUITABLE		BREEAM	SWITCH CCT SW 3000-4000	
----------	----------	------------	----------------	---	----------------------	---	--------	----------------------------	---

M1 

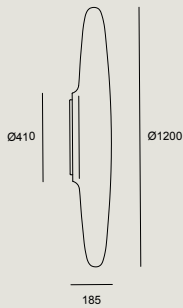

LED					
K	CRI	W LED	W Total	Real Lm	Code
SW 3000-4000	80	74	76.8	8303	15-E111 - M1 - EH
 100-277V	50-60Hz				

Venus

BODY MAT	DIF MAT		50000h	2
AL	PC		L80 B20	MacAdam



IP	IK	LOW	SEA SIDE	
65	08	FLICKER	SUITABLE	

14 Z5

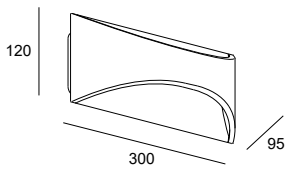



LED					
K	CRI	W LED	W Total	Real Lm	Code
3000	80	10	11	465	05-9894 - 14 - Z5 - CL
3000	80	10	11	414	
 100-240V		50-60Hz			

Diago

BODY MAT	DIF MAT		50000h	3
AL	GLA		L80 B20	MacAdam



IP	IK		SEA SIDE		BREEAM
65	05		SUITABLE		

Z5

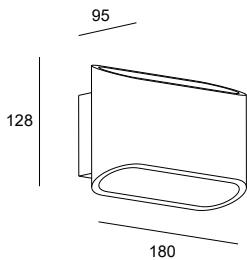

LED					
K	CRI	W LED	W Total	Real Lm	Code
3000	80	8	9.8	680	05-9873 - Z5 - CL
 100-240V		50-60Hz			

Simenti

BODY MAT	DIF MAT		50000h	2
CON	GLA		L80 B20	MacAdam



IP	IK	SEASIDE	
66	10	SUITABLE	ON-OFF

DC

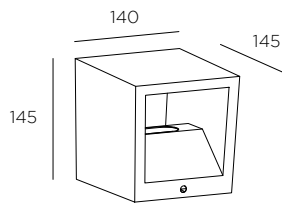

LED					
K	CRI	W LED	W Total	Real Lm	Code
3000	80	9.3	10.7	365	05-9971 - DC - CL
100-240V		50-60Hz			

Darwin

BODY MAT	DIF MAT	
PC	PC	



IP	IK	SEASIDE
54	10	SUITABLE

Z5

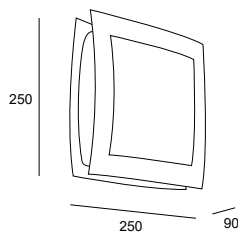

E27		
W	W Total	Code
23	23	05-9444 - Z5 - CD



Basic

BODY MAT	DIF MAT
AL	PC



Basic ist eine vielseitige Aufputzkollektion, die sowohl als Wand- als auch als Deckenleuchte eingesetzt werden kann und eine breite Palette von Varianten mit unterschiedlichen Leuchtmitteln, Farbtemperaturen und Leistungsstufen bietet. Die Konstruktion wurde jetzt weiter verbessert und die Leuchte erhielt einen neuen und effizienteren Diffusor, der für homogenes Licht ohne Blendwirkung sorgt, sowie ein wesentlich robusteres Aluminiumgehäuse, das vor der Lackierung speziell gegen Oxidation behandelt wurde, um eine Installation in ungünstigen Umgebungen wie z. B. in Küstennähe, zu ermöglichen. Der Technopolymer-Sockel und die Schutzklassen IK10 und IP66 sichern bei allen Modellen eine hohe Widerstandsfähigkeit gegen Stöße, Staub, Hochdruckwasser und dauerfeuchte Umgebungen.

Basic è una collezione da superficie versatile che può essere usata come applique o su soffitto e che offre un'ampia gamma di versioni con diverse sorgenti luminose, temperature di colore e potenze. Si presenta con un design migliorato grazie a un nuovo diffusore più efficiente, che proietta una luce omogenea senza abbagliare, e con un corpo in alluminio molto più robusto con uno speciale trattamento contro la ruggine applicato prima della verniciatura, che lo rende adatto a essere installato in ambienti con condizioni difficili, come il lungomare. La base in tecnopolimero e gli indici IK10 e IP66 di tutta la gamma ne garantiscono la resistenza agli urti, all'ingresso di polvere e acqua, all'alta pressione e agli ambienti costantemente umidi.

Verschiedene Formate Diversi formati

Basic ist in Ovalform in einer Größe mit 22 cm Breite und in Rundform in zwei Größen mit 26 cm und 36 cm Durchmesser lieferbar. Alle Varianten sind mit LED-Lichtquelle und E-27 erhältlich.

Basic dispone di una versione ovale, in un'unica misura da 22 cm di larghezza, e di una versione rotonda disponibile in 2 misure, 26 cm e 36 cm di diametro. Tutte le versioni sono disponibili con sorgente luminosa LED e E-27.



Höchste Effizienz und visueller Komfort

Massima efficienza e comfort visivo

Einer der Schlüsselfaktoren der verbesserten Basic-Kollektion ist der neue Diffusor. Es besteht aus hochwertigem, transparentem Polycarbonat mit einem Additiv, das über ein Verfahren der Wärme- und Injektionstrocknung eingemischt wird. Das Ergebnis ist eine enorm gesteigerte Effizienz ohne Einbußen bei Komfort und Homogenität des Lichts. Darüber hinaus verfügt der neue Diffusor über eine hohe Stoßfestigkeit (Klasse IK10) und einen ausgezeichneten Vergilbungsschutz, da er gegen die schädliche UV-Strahlung der Sonne behandelt wurde.

Uno dei fattori chiave della collezione Basic migliorata è il nuovo diffusore. Realizzato con polycarbonato trasparente di alta qualità mescolato a un additivo tecnico cosparsa con la tecnica di calore e asciugatura per iniezione. Il risultato è un'efficienza sensibilmente aumentata, senza dover rinunciare al comfort visivo e all'omogeneità della luce. Inoltre, il nuovo diffusore mantiene un alto indice di protezione dagli urti (livello antivandalo IK10) e un'eccellente capacità anti-ingiallimento, grazie al trattamento per la resistenza ai raggi solari UVA dannosi.

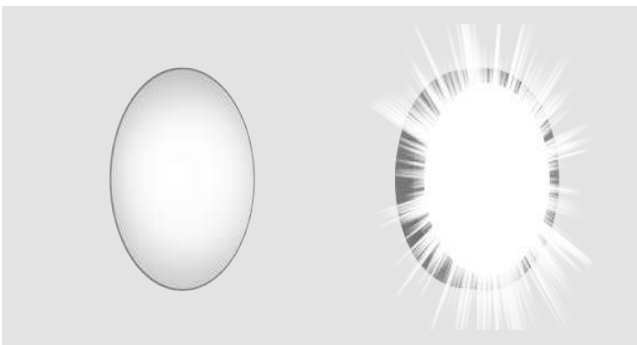

Andere marken / Altri marchi

Unregelmäßigkeit, kaum visueller Komfort oder niedrige Effizienz.

Scarsa uniformità, poco comfort visivo o bassa efficienza.

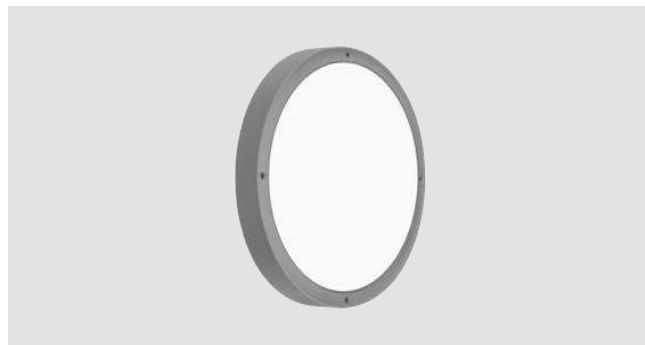

Basic LEDS C4

Gleichmäßigkeit, Komfort und Effizienz > 80 lm/W.

Uniformità, comfort ed efficienza >80Lm/W.

CCT-Technologie

Tecnologia CCT

Die Basic-Leuchten sind mit der CCT-Technologie ausgestattet, bei der Sie die Farbtemperatur über einen Schalter wählen können.

Basic nelle versioni LED integra la tecnologia CCT, con la quale è possibile scegliere la temperatura di colore tramite un interruttore.



2700K



3200K



4000K

Farbausführungen The Colour Finiture The Colour

Basic ist in allen The Colour-Ausführungen aus dem LEDS C4-Katalog erhältlich.

Basic è disponibile in tutte le finiture The Colour del catalogo LEDS C4.



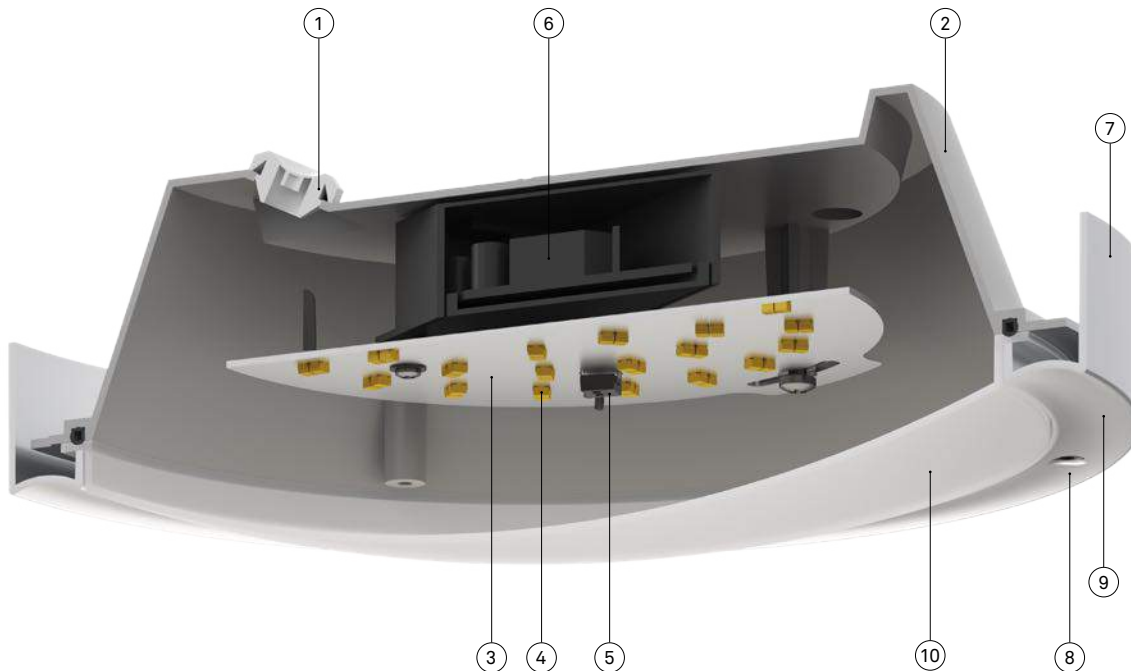

① **Kabelverschraubungen**
Premistoppa

IP66 mit höchster Schutzwirkung.
IP66 per una massima protezione.

② **Sockel**
Base

Hergestellt aus
Technopolymer für erhöhte
Feuchtigkeitsbeständigkeit.
Di tecnopolimero per una maggiore
resistenza all'umidità.

③ **Wärmeableiter**
Dissipatore

Hergestellt aus Aluminium, um L80
B20 bei 50.000 h zu gewährleisten.
Di alluminio per garantire 50.000h
L80 B20.

④ **Lichtquelle**
Sorgente luminosa

LED CRI80 und in E-27 erhältlich.
LED CRI80 e disponibile in E-27.

⑤ **CCT-Switch**
Switch CCT

2700K, 3200K und 4000K.
2700K, 3200K e 4000K.

⑥ **Vorschaltgerät**
Attrezzatura

Bei allen LED-Versionen enthalten.
Inclusa in tutte le versioni LED.

⑦ **Gehäuse**
Corpo

Hergestellt aus
robustem Aluminium mit
Korrosionsschutzbehandlung.
Di alluminio per maggiore
robustezza e con trattamento
antiruggine.

⑧ **Befestigungsschrauben**
Bulloneria

Edelstahl AISI316.
Acciaio inossidabile AISI316.

⑨ **Ausführungen**
Finiture

Erhältlich in der gesamten
The Colour-Farbpalette.
Disponibile in tutta la gamma
The Colour.

⑩ **Diffusor**
Diffusore

Hergestellt aus IK10-Polycarbonat
und hocheffizient (BREEAM-
zertifiziert).
In policarbonato IK10 e ultra
efficiente (con certificato
BREEAM).

BASIC

Basic Wall Fixture Aluminium

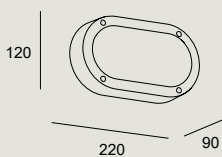

	66	10	L80 B20	MacAdam	SUITABLE			SW 2700-3200-4000

14* 34* 60* DL* E3* J6* Z5

LED						
K	CRI	W LED	W Total	Real Lm	Code	
					14	
					34	
					60	
SW 2700-3200-4000	80	6.7	8.5	674	05-E102 -	DL - EH
					E3	
					J6	
					Z5	
220-240V		50-60Hz				

	66	10	SUITABLE

14* 34* 60* DL* E3* J6* Z5

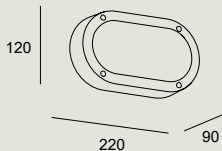

E27	
W	Code
	14
	34
	60
max. 15	05-9886 - DL - M1
	E3
	J6
	Z5

*Fragen Sie unser Verkaufsteam nach den Lieferbedingungen.
Consultare i termini e le condizioni di consegna al nostro team commerciale.

BASIC

Basic Wall Fixture

NEW		IP 66	IK 10	SEA SIDE SUITABLE
-----	--	----------	----------	----------------------

14* 34* 60* DL* E3* J6* Z5

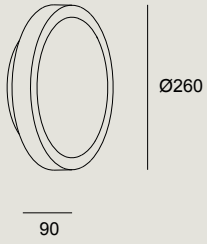

E27	
W	Code
	14
	34
	60
1 x max. 15	15-9835 - DL - M1
	E3
	J6
	Z5

NEW		IP 66	IK 10	50000h L80 B20	3 MacAdam	UGR <22	SEA SIDE SUITABLE		BREEAM
-----	--	----------	----------	-------------------	--------------	------------	----------------------	--	--------

SWITCH CCT
SW 2700-3200-4000

14* 34* 60* DL* E3* J6* Z5

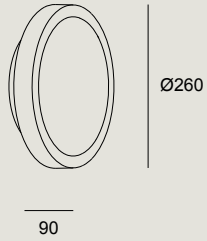

LED						
K	CRI	W LED	W Total	Real Lm	Code	
					14	
					34	
					60	
SW 2700-3200-4000	80	11.7	13.5	1269	15-E049 - DL - EH	
					E3	
					J6	
					Z5	
	220-240V	50-60Hz				

*Fragen Sie unser Verkaufsteam nach den Lieferbedingungen.

Consultare i termini e le condizioni di consegna al nostro team commerciale.

BASIC

Basic Wall Fixture

NEW		IP	IK	SEA SIDE
		66	10	SUITABLE

14* 34* 60* DL* E3* J6* Z5

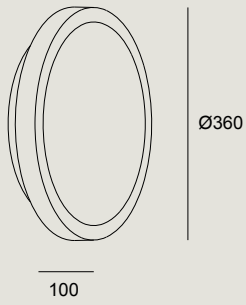

E27		
W	W Total	Code
		14
		34
		60
2 x max. 15	30	15-E041 - DL - M1
		E3
		J6
		Z5

NEW		IP	IK	50000h	3	UGR	LOW	SEA SIDE	
		66	10	L80 B20	MacAdam	<22	FLICKER	SUITABLE	ON-OFF

BREEAM	SWITCH CCT
	SW 2700-3200-4000

14* 34* 60* DL* E3* J6* Z5

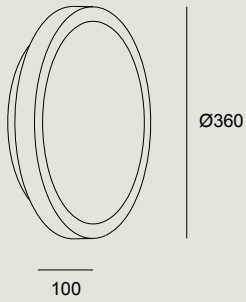

LED					
K	CRI	W LED	W Total	Real Lm	Code
					14
					34
					60
SW 2700-3200-4000	80	21.4	24	2606	15-E050 - DL - EH
					E3
					J6
					Z5
220-240V	50-60Hz				

*Fragen Sie unser Verkaufsteam nach den Lieferbedingungen.

Consultare i termini e le condizioni di consegna al nostro team commerciale.

Curie

BODY MAT
AL

DIF MAT
GLA



IP
65

IK
05

SEA SIDE SUITABLE

Z5 ●

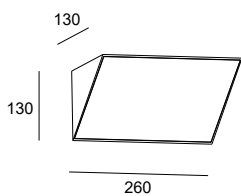

LED					
K	CRI	W	W Total	Real Lm	Code
3000	80	14	15.3	412	05-9884 - Z5 - CL
4000	80	14	15.3	412	05-9884 - Z5 - CM

	100-240V	50-60Hz
--	----------	---------



IP
65

IK
05



SEA SIDE SUITABLE

Z5 ●

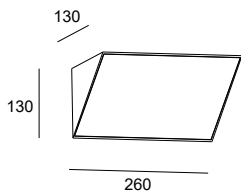

E27	
W	Code
max. 60	05-9884 - Z5 - G5

Curie

BODY MAT
AL

DIF MAT
GLA



IP	IK	50000h	3		SEA SIDE SUITABLE		BREEAM
65	05	L80 B20	MacAdam			ON-OFF	

Z5 ●

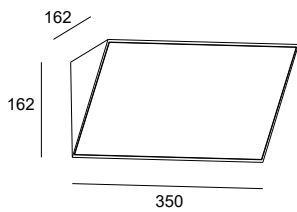

LED						
K	CRI	W LED	W Total	Real Lm	Code	
3000	80	25.2	27.6	1530	05-9993 - Z5 - CL	
4000	80	25.2	27.6	1530	05-9993 - Z5 - CM	
		100-240V 50-60Hz				



IP	IK		SEA SIDE SUITABLE
65	05		



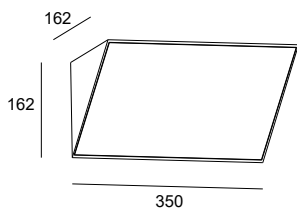



Z5 ●

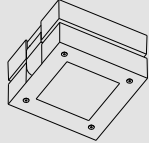
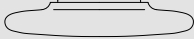

E27	
W	Code
2 x max.40	05-9993 - Z5 - G5

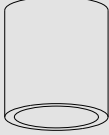

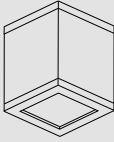
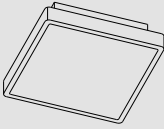
Deckenleuchten Plafoniere

 <p>Modis 835</p>	 <p>Mega 841</p>	 <p>Max 845</p>	 <p>Cosmos 848</p>	 <p>Soul 850</p>
 <p>Solid 852</p>	 <p>Afrodita 854</p>	 <p>Kössel 855</p>	 <p>Basic 856</p>	



Modis

LUCA TURRINI 2022

BODY MAT	DIF MAT		50000h	3
AL	GLA		L80 B20	MacAdam



Modis ist ein neuer Vorschlag für den Außenbereich mit einer ausgeprägt dekorativen Komponente. Ein klares und neutrales Profil sowie eine Konstruktion, die eine hohe Beweglichkeit des Kugelgelenks erlaubt und die Möglichkeit bietet, die Abstrahlungsart zu wählen, denn die Leuchte ist wahlweise mit konzentriertem oder gebündeltem Licht erhältlich. Die vielköpfige Familie der Kollektion und ihre Kompositionsmöglichkeiten machen sie zu einer Lösung, die sich durch ihre Vielseitigkeit auszeichnet und sich meisterhaft und elegant an die Anforderungen von Projekten anpasst, die ein ästhetisches Gleichgewicht im Gesamtbild erfordern. Neben den dekorativen Vorzügen wurde auch den technischen Aspekten große Aufmerksamkeit gewidmet, um die Vielseitigkeit der Familie noch stärker zu betonen. Modis weist eine hohe Stoßfestigkeit (IK10), Staubdichtheit und Hochdruckwasserbeständigkeit (IP66) auf und kann dank der KTL-Grundierung auch in Umgebungen mit harter Seeluft aufgestellt werden.

Modis è una nuova proposta da esterno con una grande componente decorativa. Dal profilo pulito e neutro, il suo design si basa sulla grande capacità di movimento dello snodo e sulla possibilità di scegliere il fascio di luce, con opzione luce concentrata o diffusa. La grande famiglia della collezione e le sue possibilità compositive la trasformano in una scelta caratterizzata da versatilità e adattabile con maestria ed eleganza alle esigenze di progetti che richiedono insieme esteticamente equilibrati. Oltre al valore decorativo, gli aspetti tecnici sono stati curati fin nei minimi dettagli, per offrire una linea ancora più polivalente. Modis ha una grandissima resistenza agli urti (IK10), un'eccellente protezione dall'ingresso di polvere e acqua ad alta pressione (IP66) e può essere installata in ambienti con atmosfera marina, grazie al processo di verniciatura in cataforesi.

Beleuchtungsanlagen Sistemi di illuminazione

Alle Mitglieder der Modis-Familie sind mit zwei Innenmodulen erhältlich, bei denen je nach den Anforderungen der zu beleuchtenden Umgebung zwischen Opal- und Optics-Optik gewählt werden kann. Die Opal-Variante ist für die Grundbeleuchtung vorgesehen und mit der Optik-Option kann der Lichtschein zum Hervorheben von einzelnen Objekten oder Szenen gebündelt werden, wobei die Optiken Spot 18°, Medium 34° und Flood 48° zur Auswahl stehen. Darüber hinaus bietet die Optics-Variante einen hervorragenden visuellen Komfort (UGR<16) und eine hohe Lichtqualität (CRI90).

In tutta la famiglia Modis presenta due moduli interni a scelta tra ottica Opal e Optics, in base alle esigenze dell'ambiente da illuminare. La versione Opal offre un'illuminazione generale mentre l'opzione Optics consente di concentrare il fascio per mettere in risalto oggetti o scene concrete, con la possibilità di scegliere tra ottica Spot 18°, Medium 34° e Flood 48°. Inoltre, la versione Optics offre un grande comfort visivo (UGR<16) e una luce di qualità (CRI90).

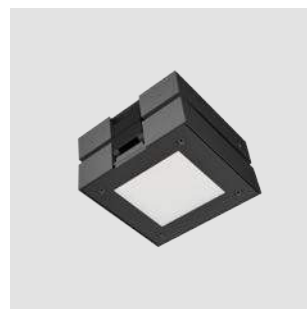

Opal



Optics

MODIS

Modis Opal Wall Fixture/Spotlight/ Ceiling

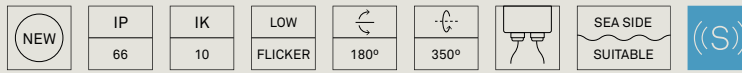

14* 34* 60* DL* E3* J6* Z5

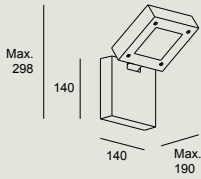

LED																											
K	CRI	W LED	W Total	Real Lm	Code																						
SW 2700-3200-4000	80	11.6	13.2	744	14																						
					34																						
					60	DU																					
					DL	OU																					
					E3	XB																					
					J6																						
Z5																											
<table border="0"> <tr> <td></td> <td>XB Casambi</td> <td>220-240V</td> <td>50-60Hz</td> <td colspan="3"></td> </tr> <tr> <td></td> <td>DU DALI-2</td> <td>100-277V</td> <td>50-60Hz</td> <td colspan="3"></td> </tr> <tr> <td></td> <td>OU ON-OFF</td> <td>100-277V</td> <td>50-60Hz</td> <td colspan="3"></td> </tr> </table>								XB Casambi	220-240V	50-60Hz					DU DALI-2	100-277V	50-60Hz					OU ON-OFF	100-277V	50-60Hz			
	XB Casambi	220-240V	50-60Hz																								
	DU DALI-2	100-277V	50-60Hz																								
	OU ON-OFF	100-277V	50-60Hz																								



nicht inklusive / Non incluso	
Pflock 235 mm / Paletto 235mm	71-9997-05-05
Pflock 302mm / Paletto 302mm	71-9998-05-05



14* 34* 60* DL* E3* J6* Z5

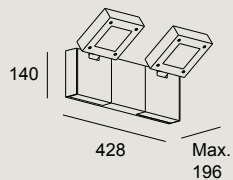

LED																											
K	CRI	W LED	W Total	Real Lm	Code																						
SW 2700-3200-4000	80	11.6	26.4	1488	14																						
					34																						
					60	DU																					
					DL	OU																					
					E3	XB																					
					J6																						
Z5																											
<table border="0"> <tr> <td></td> <td>XB Casambi</td> <td>220-240V</td> <td>50-60Hz</td> <td colspan="3"></td> </tr> <tr> <td></td> <td>DU DALI-2</td> <td>100-277V</td> <td>50-60Hz</td> <td colspan="3"></td> </tr> <tr> <td></td> <td>OU ON-OFF</td> <td>100-277V</td> <td>50-60Hz</td> <td colspan="3"></td> </tr> </table>								XB Casambi	220-240V	50-60Hz					DU DALI-2	100-277V	50-60Hz					OU ON-OFF	100-277V	50-60Hz			
	XB Casambi	220-240V	50-60Hz																								
	DU DALI-2	100-277V	50-60Hz																								
	OU ON-OFF	100-277V	50-60Hz																								



nicht inklusive / Non incluso	
Verkettungszubehör Leuchtenkopf extra weiß / Access. extra di collegamento in serie testa bianco	71-E235-14-00
Verkettungszubehör Leuchtenkopf extra schwarz / Access. extra di collegamento in serie testa nero	71-E235-60-00
Verkettungszubehör Leuchtenkopf extra hellgrau / Access. extra di collegamento in serie testa grigio chiaro	71-E235-34-00
Verkettungszubehör Leuchtenkopf extra braun / Access. extra di collegamento in serie testa marrone	71-E235-J6-00
Verkettungszubehör Leuchtenkopf tannengrün / Access. extra di collegamento in serie testa verde abete	71-E235-E3-00
Verkettungszubehör Leuchtenkopf extra gold / Access. extra di collegamento in serie testa dorato	71-E235-DL-00
Verkettungszubehör Leuchtenkopf extra grau / Access. extra di collegamento in serie testa grigio	71-E235-Z5-00

MODIS

Modis Opal Wall Fixture/Spotlight/ Ceiling



14* 34* 60* DL* E3* J6* Z5

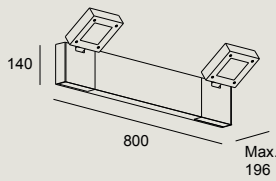

LED						
K	CRI	W LED	W Total	Real Lm	Code	
					14	
					34	
					60	DU
SW 2700-3200-4000	80	11.6	26.4	1488	05-E064 - DL -	OU
					E3	XB
					J6	
					Z5	

XB	Casambi	220-240V	50-60Hz
DU	DALI-2	100-277V	50-60Hz
OU	ON-OFF	100-277V	50-60Hz



nicht inklusive / Non incluso		
Verkettungszubehör Leuchtenkopf extra weiß / Access. extra di collegamento in serie testa bianco		71-E235-14-00
Verkettungszubehör Leuchtenkopf extra schwarz / Access. extra di collegamento in serie testa nero		71-E235-60-00
Verkettungszubehör Leuchtenkopf extra hellgrau / Access. extra di collegamento in serie testa grigio chiaro		71-E235-34-00
Verkettungszubehör Leuchtenkopf extra braun / Access. extra di collegamento in serie testa marrone		71-E235-J6-00
Verkettungszubehör Leuchtenkopf tannengrün / Access. extra di collegamento in serie testa verde abete		71-E235-E3-00
Verkettungszubehör Leuchtenkopf extra gold / Access. extra di collegamento in serie testa dorato		71-E235-DL-00
Verkettungszubehör Leuchtenkopf extra grau / Access. extra di collegamento in serie testa grigio		71-E235-Z5-00

nicht mitgeliefertes allgemeines Zub. Access. comuni non inclusi		
Blende weiß Visiera bianca		71-E234-14-00
Blende hellgrau Visiera grigio chiaro		71-E234-34-00
Blende schwarz Visiera nera		71-E234-60-00
Blende gold Visiera dorata		71-E234-DL-00
Blende tannengrün Visiera verde abete		71-E234-E3-00
Blende braun Visiera marrone		71-E234-J6-00
Blende grau Visiera grigia		71-E234-Z5-00

*Fragen Sie unser Verkaufsteam nach den Lieferbedingungen.
Consultare i termini e le condizioni di consegna al nostro team commerciale.

MODIS

Modis Optics Wall Fixture/Spotlight/ Ceiling



Codebeispiel / Esempio di codice: AS11-18V9S3OUZ5

Model	W	K/ Cri/ Real lm	Optics	Source	Finishes
AS11 - ↻180°	18 18,3W	V9 2700K CRI90/1301 lm	S3 16°	OU ON-OFF 100-277V 50-60Hz	Z5
		W9 3000K CRI90/1301 lm	M3 33°	DS DALI-2 220-240V 50-60Hz	14*
		X9 4000K CRI90/1301 lm	F1 48°	XB CASAMBI 220-240V 50-60Hz	60*
					34*
					J6*
					E3*
					DL*



nicht inklusive / Non incluso	
Pflock 235 mm / Paletto 235mm	71-9997-05-05
Pflock 302mm / Paletto 302mm	71-9998-05-05



Codebeispiel / Esempio di codice: AS12-37V9S3OUZ5

Model	W	K/ Cri/ Real lm	Optics	Source	Finishes
AS12 - ↻180°	37 36,6W	V9 2700K CRI90/2602 lm	S3 16°	OU ON-OFF 100-277V 50-60Hz	Z5
		W9 3000K CRI90/2602 lm	M3 33°	DS DALI-2 220-240V 50-60Hz	14*
		X9 4000K CRI90/2602 lm	F1 48°	XB CASAMBI 220-240V 50-60Hz	60*
					34*
					J6*
					E3*
					DL*

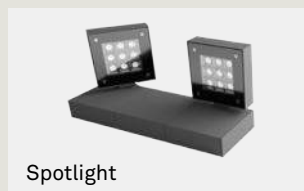

nicht inklusive / Non incluso	
Verkettungszubehör Leuchtenkopf extra weiß / Access. extra di collegamento in serie testa bianco	71-E235-14-00
Verkettungszubehör Leuchtenkopf extra schwarz / Access. extra di collegamento in serie testa nero	71-E235-60-00
Verkettungszubehör Leuchtenkopf extra hellgrau / Access. extra di collegamento in serie testa grigio chiaro	71-E235-34-00
Verkettungszubehör Leuchtenkopf extra braun / Access. extra di collegamento in serie testa marrone	71-E235-J6-00
Verkettungszubehör Leuchtenkopf tannengrün / Access. extra di collegamento in serie testa verde abete	71-E235-E3-00
Verkettungszubehör Leuchtenkopf extra gold / Access. extra di collegamento in serie testa dorato	71-E235-DL-00
Verkettungszubehör Leuchtenkopf extra grau / Access. extra di collegamento in serie testa grigio	71-E235-Z5-00

*Fragen Sie unser Verkaufsteam nach den Lieferbedingungen.
Consultare i termini e le condizioni di consegna al nostro team commerciale.

MODIS

Modis Optics Wall Fixture/Spotlight/ Ceiling

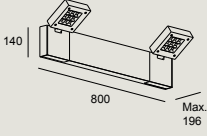

Codebeispiel / Esempio di codice: AS13-37V9S30UZ5

Model	W	K/ Cri/ Real lm	Optics	Source	Finishes
AS13 - 	37 36,6W	V9 2700K CRI90/2602 lm	S3 16°	OU ON-OFF 100-277V 50-60Hz	Z5
		W9 3000K CRI90/2602 lm	M3 33°	DS DALI-2 220-240V 50-60Hz	14*
		X9 4000K CRI90/2602 lm	F1 48°	XB CASAMBI 220-240V 50-60Hz	60* 34* J6* E3* DL*



nicht inklusive / Non incluso	
Verkettungszubehör Leuchtenkopf extra weiß / Access. extra di collegamento in serie testa bianco	71-E235-14-00
Verkettungszubehör Leuchtenkopf extra schwarz / Access. extra di collegamento in serie testa nero	71-E235-60-00
Verkettungszubehör Leuchtenkopf extra hellgrau / Access. extra di collegamento in serie testa grigio chiaro	71-E235-34-00
Verkettungszubehör Leuchtenkopf extra braun / Access. extra di collegamento in serie testa marrone	71-E235-J6-00
Verkettungszubehör Leuchtenkopf tannengrün / Access. extra di collegamento in serie testa verde abete	71-E235-E3-00
Verkettungszubehör Leuchtenkopf extra gold / Access. extra di collegamento in serie testa dorato	71-E235-DL-00
Verkettungszubehör Leuchtenkopf extra grau / Access. extra di collegamento in serie testa grigio	71-E235-Z5-00

nicht mitgeliefertes allgemeines Zub. Access. comuni non inclusi	Blende weiß Visiera bianca	71-E234-14-00
	Blende hellgrau Visiera grigio chiaro	71-E234-34-00
	Blende schwarz Visiera nera	71-E234-60-00
	Blende gold Visiera dorata	71-E234-DL-00
	Blende tannengrün Visiera verde abete	71-E234-E3-00
	Blende braun Visiera marrone	71-E234-J6-00
	Blende grau Visiera grigia	71-E234-Z5-00

*Fragen Sie unser Verkaufsteam nach den Lieferbedingungen.

Consultare i termini e le condizioni di consegna al nostro team commerciale.



Mega

BODY MAT	DIF MAT		50000h	3
AL	PLABS		L80 B20	MacAdam



Großformatige Deckenleuchten zur einheitlichen Ausleuchtung großer Räume wie Eingangsbereiche, Vordächer und Terrassen von Hotels, Einkaufszentren, Flughäfen und öffentlichen Räumen. Mega ist in zwei Größen mit 80 cm und 120 cm Durchmesser erhältlich und ist mit der CCT-Technologie ausgestattet, bei der Sie die Farbtemperatur über einen Schalter wählen können. Die Kollektion gibt ein einheitliches und komfortables Licht und enthält einen DALI-Treiber.

Plafoniere di grandi dimensioni per illuminare, in modo omogeneo, grandi spazi come zone di ingresso, porticati e terrazze di hotel, centri commerciali, aeroporti e spazi pubblici. Mega è disponibile in due misure, 80 cm e 120 cm di diametro, e incorpora la tecnologia CCT, con la quale è possibile scegliere la temperatura di colore, tramite un interruttore. La collezione proietta una luce uniforme e confortevole ed include un driver DALI dimmerabile.

Gleichmäßigkeit Omogeneità

Das große Format von Mega macht es zur perfekten Wahl für die Beleuchtung großer Räume, die Eleganz und Qualität zu gleichen Teilen erfordern. Mega bietet einen gleichmäßigen Lichtstrahl in verschiedenen Farbtemperaturen.

Le grandi dimensioni di Mega, lo rendono l'opzione ideale per illuminare grandi spazi che richiedano eleganza e qualità, nella stessa misura. Mega offre un fascio di luce omogeneo in diverse temperature di colore.



CCT-Technologie Tecnologia CCT

Der eingebaute Schalter ermöglicht die Änderung der Farbtemperatur ausgehend von einer einzelnen Artikels.

Lo switch integrato permette la variazione della temperatura di colore, partendo da un unico codice di riferimento.



**Höchste Langlebigkeit
und Widerstandsfähigkeit**
**Massima durabilità
e resistenza**

Mit einem Sockel aus Aluminiumdruckguss und einem im Rotationsgussverfahren hergestellten Polyethylen-Diffusor, die die Lebensdauer des Produkts maximieren und seine Installation in nassen Umgebungen oder sogar direkt am Meer ermöglichen.

Dotato di una base in alluminio iniettato e di un diffusore in polietilene, realizzato con stampato rotazionale, per massimizzare la vita utile del prodotto e permettere la sua installazione, in ambienti umidi o anche sul lungomare.





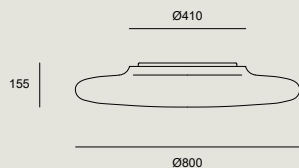

MEGA

IP 65	IK 10	UGR <16	LOW FLICKER		SEA SIDE SUITABLE	 DALI	BREEAM	SWITCH CCT SW 3000-4000	
----------	----------	------------	----------------	--	----------------------	---	--------	----------------------------	--

M1 



LED						
K	CRI	W LED	W Total	Real Lm	Code	
SW 3000-4000	80	74	76.8	8062	15-E110 - M1 - EH	
 100-277V		50-60Hz				

IP 65	IK 10	UGR <13	LOW FLICKER		SEA SIDE SUITABLE	 DALI	BREEAM	SWITCH CCT SW 3000-4000	
----------	----------	------------	----------------	---	----------------------	--	--------	----------------------------	---

M1 

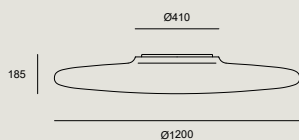

LED						
K	CRI	W LED	W Total	Real Lm	Code	
SW 3000-4000	80	74	76.8	8303	15-E111 - M1 - EH	
 100-277V		50-60Hz				



MAX



Video ansehen
Guarda il video

Ökodesign Ecodesign

Das neutrale und kompakte Design der Max-Deckenlampe ermöglicht den Einbau in alle Arten von Umgebungen, was sie zu einem jederzeit attraktiven, diskreten und eleganten Produkt macht. Sie verfügt über ein Gehäuse aus maschinell gefertigtem Aluminium und ist mit einem Glasdiffusor, vier Ausstrahlwinkeln (ultraspot bis ultraflood) und drei Farbtemperaturen (2700 K, 3000 K und 4000 K) erhältlich. Sie kann zudem mit Streulicht-, ovalen, quadratischen und Wabenplatten-Filtern ergänzt werden. Hinzu kommen drei größere und leistungsstärkere Modelle, die alle mit den von LEDS C4 angebotenen Farben individuell gestaltet werden können.

Il design neutro e compatto di Max a soffitto la rende adatta a essere installata in qualsiasi tipo di ambiente, rivelandosi un articolo attraente, discreto ed elegante in qualsiasi momento. È fornita con un corpo in alluminio meccanizzato e un diffusore in vetro, 4 angolazioni di apertura (ultraspot - ultraflood) e 3 temperature di colore (2700K, 3000K y 4000K). Inoltre, può essere completata con filtri di luce diffusa, ovale, quadrata e pannelli a nido d'ape. Sono presenti 3 modelli più grandi e più potenti, tutti personalizzabili con i colori offerti dalla LEDS C4.

Ökodesign dank austauschbarer LED-Module. Mit einem niedrigen Blendungswert von UGR <12 weist Max einen hohen Sehkomfort auf und bietet mit einer hohen Farbwiedergabe von CRI90.

Il suo design risponde a un parametro ecologico, grazie all'utilizzo di moduli LED sostituibili. Dotato di un elevato comfort visivo contraddistinto da un UGR < 12, Max offre un'elevata resa cromatica con un CRI90.



Smart

Die Max-Deckenleuchten sind Smart und werden mit einem Bluetooth-Gerät mit integrierter Casambi-Technologie geliefert, das eine herkömmliche Installation mit Phase, Neutral und Erde ermöglicht.

Le plafoniere Max sono Smart e sono fornite con un dispositivo Bluetooth che incorpora la tecnologia Casambi, permettendo un'installazione tradizionale di fase neutra e terra.

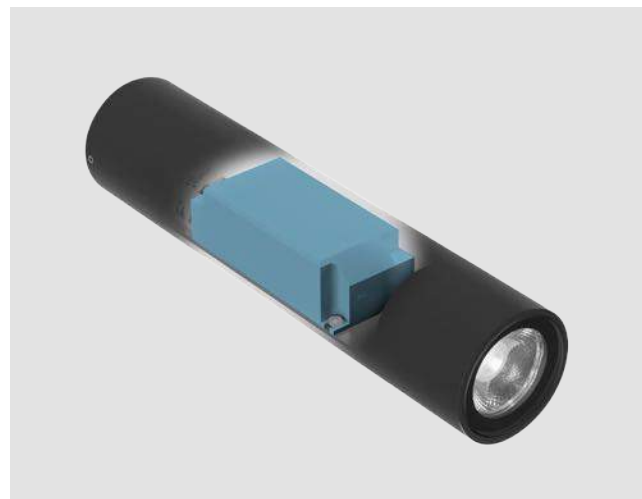

MAX

Max Ceiling

BODY MAT		IK	SEA SIDE	IP	
AL		10	SUITABLE	66	

Codebeispiel / Esempio di codice: AI22-P3V9S10S25

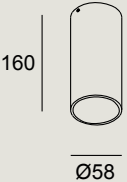
Model	W	K/ Cri/ Real lm	Optics	Source	Finishes
AI22 - Rund / Rotondo   160 Ø58	P3 3,4W	V9 2700K CRI90 257 lm	S1 9°	OS ON-OFF 220-240V 50-60Hz	Z5
		W9 3000K CRI90/286 lm			14*
		X9 4000K CRI90/286 lm			60*
	P6 5,3W	V9 2700K CRI90/519 lm	S2 17°	OS ON-OFF 220-240V 50-60Hz	34*
		W9 3000K CRI90/519 lm			J6*
		X9 4000K CRI90/519 lm			E3*
			F1 50°		DL*

BODY MAT	DIF MAT		IK	SEA SIDE	IP	
AL	GLA		10	SUITABLE	66	

Codebeispiel / Esempio di codice: AI25-P6V9S1DUZ5

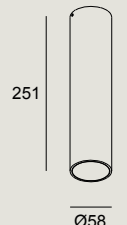
Model	W	K/ Cri/ Real lm	Optics	Source	Finishes
AI25 - Rund / Rotondo   251 Ø58	P6 6W	V9 2700K CRI90/373 lm	S1 9°	DU DALI-2 100-277V 50-60Hz	Z5
		W9 3000K CRI90/373 lm		XB CASAMBI 220-240V 50-60Hz	14*
		X9 4000K CRI90/373 lm			60*
	P8 8,9W	V9 2700K CRI90/610 lm	S2 17°	DU DALI-2 100-277V 50-60Hz	34*
		W9 3000K CRI90/610 lm			J6*
		X9 4000K CRI90/610 lm			E3*
			F1 50°		DL*

nicht mitgeliefertes allgemeines Zub. Access. comuni non inclusi	5 Wabenraster 5 pannelli a nido d'ape	71-E131-00-00
	5 Lichtfilter für gestreute Lichtkegel 5 filtri per l'emissione di luce diffusa	71-E133-00-00
	5 Lichtfilter für quadratische Lichtkegel 5 filtri per l'emissione di luce quadrata	71-E135-00-00
	5 Lichtfilter für elliptische Lichtkegel 5 filtri per emettere luce ellittica	71-E141-00-00

*Fragen Sie unser Verkaufsteam nach den Lieferbedingungen.
Consultare i termini e le condizioni di consegna al nostro team commerciale.

MAX

Max Ceiling

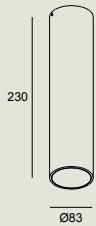

Codebeispiel / Esempio di codice: AT22-18V9S30SZ5

Model	W	K/ Cri/ Real lm	Optics	Source	Finishes
AT22 - Rund / Rotondo  	18 17,3W	V9 2700K CRI90/1902 lm	S3 21°	OS ON-OFF 220-240V 50-60Hz	Z5
		W9 3000K CRI90/2047 lm	M3 31°	DU DALI-2 100-277V 50-60Hz	14*
		X9 4000K CRI90/2191 lm	F1 40°	XB CASAMBI 220-240V/50- 60Hz	60*
					34*
					J6*
					E3*
					DL*

nicht inklusive / Non incluso	
5 Lichtfilter für gestreute Lichtkegel / 5 filtri per l'emissione di luce diffusa	71-E260-00-00
5 Lichtfilter für elliptische Lichtkegel / 5 filtri per emettere luce ellittica	71-E261-00-00
5 Lichtfilter für quadratische Lichtkegel / 5 filtri per l'emissione di luce quadrata	71-E262-00-00
5 Wabenraster / 5 pannelli a nido d'ape	71-E263-00-00

*Fragen Sie unser Verkaufsteam nach den Lieferbedingungen.
 Consultare i termini e le condizioni di consegna al nostro team commerciale.

Cosmos

BODY MAT	DIF MAT	
AL	GLA	



NEW	IP 65	IK 08	50000h L80 B20	3 MacAdam	SEA SIDE SUITABLE	ON-OFF	BREEAM
------------	----------	----------	-------------------	--------------	----------------------	--------	--------

14* 34* 60* DL* E3* J6* Z5

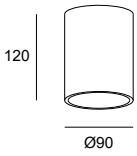

LED						
K	CRI	W LED	W Total	Real Lm	Code	
3000	80	8.3	9.5	1002	15-E020 - 14	CL
					DL - 34	
					E3 - 60	
					J6 -	
					Z5 -	
4000	80	8.3	9.5	1002	15-E020 - 14	CM
					DL - 34	
					E3 - 60	
					J6 -	
					Z5 -	
220-240V 50-60Hz						



IP 65	IK 08	50000h L80 B20	2 MacAdam	SEA SIDE SUITABLE	ON-OFF	BREEAM
----------	----------	-------------------	--------------	----------------------	--------	--------

14* 34* 60* DL* E3* J6* Z5

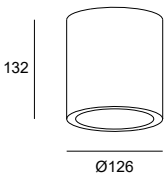

LED						
K	CRI	W LED	W Total	Real Lm	Code	
3000	80	12	17.6	1118	15-9790 - 14	CL
					DL - 34	
					E3 - 60	
					J6 -	
					Z5 -	
4000	80	12	17.6	1118	15-9790 - 14	CM
					DL - 34	
					E3 - 60	
					J6 -	
					Z5 -	
100-240V 50-60Hz						

Cosmos

BODY MAT
AL

DIF MAT
GLA



IP	IK	50000h	2	SEA SIDE	ON-OFF	BREEAM
65	08	L80 B20	MacAdam	SUITABLE		

14* ○ 34* ● 60* ● DL* ● E3* ● J6* ● Z5 ●

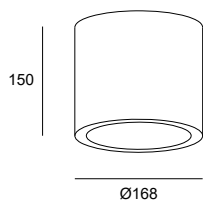

LED						
K	CRI	W LED	W Total	Real Lm	Code	
3000	80	23	25.8	2061	14	15-9904 - DL - CL
					34	
					60	
					E3	
					J6	
4000	80	23	25.8	2061	Z5	15-9904 - DL - CM
					14	
					34	
					60	
					J6	
					Z5	
100-240V		50-60Hz				

mitgeliefertes allgemeines Zub. Dekorefektor 2 Farben
 Access. comuni inclusi Deco riflettore 2 colori

*Fragen Sie unser Verkaufsteam nach den Lieferbedingungen.
 Consultare i termini e le condizioni di consegna al nostro team commerciale.

Soul

BODY MAT	DIF MAT	50000h	3
AL	GLA	L80 B20	MacAdam



Video ansehen
Guarda il video

Vielseitige und professionelle Kollektion von Uplights und Downlights für den Aufputzeinbau mit ultraflachem und sauberem Design und hervorragender Farbwiedergabe durch mitgelieferte CRI90-Leuchtmittel. Ohne sichtbare Verschraubungen und mit hohem visuellem Komfort wurde sie für die Beleuchtung in Projekten mit anspruchsvoller architektonischer Integration entwickelt. Soul ist eine Kollektion zur Beleuchtung von Pflanzen, Denkmälern, Säulen oder sonstigen architektonischen Elementen, wenn es keine Möglichkeit zum versenkten Einbau oder zur Entwässerung gibt. Die Leuchten sind mit integriertem EIN-AUS-Schalter, DALI oder Casambi lieferbar und erleichtern so die Installation. Es gibt sie in zwei Durchmessern, mit 20 und 26 cm, mit verschiedener Leistung, drei Farbtemperaturen (2700K, 3000K und 4000K) und drei Lichtaustrittswinkeln (18°, 35° und 49°). Mit dem als Zubehör erhältlichen Filter kann ein Wall-Washer-Effekt erzeugt werden.

Collezione di faretti uplight e downlight di superficie, versatili e professionali, dal design ultrapiatto e pulito, senza bulloneria a vista e con un grande comfort visivo, pensata per illuminare progetti con un'eccellente integrazione architettonica e un'elevata riproduzione cromatica grazie al CRI90 di serie. Soul è una collezione progettata per illuminare piante, monumenti, colonne o altri elementi architettonici senza fori e senza la necessità di creare drenaggi. È disponibile con dispositivo ON-OFF, DALI o Casambi integrato all'interno dell'apparecchio, che lo rende più facile da installare. È disponibile in due diametri, 20 e 26 cm, offre varie potenze, 3 temperature di colore (2700K, 3000K e 4000K) e 3 angoli di luce (18°, 35° e 49°). Dispone di un accessorio di filtro opzionale per dirigere la luce e ottenere un effetto wallwasher.

Höchster visueller Komfort Massimo comfort visivo

Die Konfiguration mit einzelnen versenkten optischen Modulen sorgt für eine einheitliche Ausleuchtung und hohen visuellen Komfort. Dies erzeugt einen Dark-Light-Effekt. Dieser Effekt entsteht, wenn trotz eingeschalteter Leuchte der Eindruck erweckt wird, dass diese ausgeschaltet ist.

La sua configurazione, con singoli moduli ottici incassati, garantisce un'illuminazione omogenea, un grande comfort visivo e crea un effetto Dark Light. Questo effetto si verifica quando la lampada, anche se accesa, sembra essere spenta.



Höchste Langlebigkeit und Widerstandsfähigkeit Massima durabilità e resistenza

Bestehend aus einem Aluminiumdruckgussgehäuse, einem AISI316-Edelstahlsockel und einem Glasdiffusor. Diese Komponenten erhöhen die Lebensdauer des Produkts und ermöglichen eine Installation in nassen Umgebungen oder sogar direkt in Meeresnähe. Zusätzlich verfügt sie über einen doppelten Kabelausgang, um die Installation in Reihe zu vereinfachen. Dotato di un corpo in alluminio iniettato, base in acciaio inox AISI316 e un diffusore in vetro, per massimizzare la vita utile del prodotto e permettere la sua installazione in ambienti umidi o anche sul lungomare. Dispone inoltre di una doppia uscita del cavo per facilitare l'installazione in serie.

SOUL

IP 66/67	IK 10	1000 Kg		SEA SIDE SUITABLE	BREEAM
-------------	----------	---------	--	----------------------	--------

Model	W	K/ Cri/ Real lm	Optics	Source	Finishes
AL11 - 	P6 6.1W	V9 2700K/CRI90 425 lm	S2 18°	OU ON-OFF 100-277V 50-60Hz	Z5 ●
		W9 3000K/CRI90 417 lm	M3 35°	BB 9V/Max. 700mA	
		X9 4000K/CRI90 462 lm	F1 49°		

 42 | Ø195

AL11	IP		u. min			u. max			Code
			220-240V			110-127V			
IP68	ON-OFF		1	1	1	1	1	71-E014-00-00	
	DALI		1	4	2	2	2	71-E080-00-00	
	0-10V		1	2	2	2	2	71-E081-00-00	
IP70	ON-OFF		1	8	6	6	6	71-3542-00-00	
	DALI		1	8	6	6	6	71-4706-00-00	
	0-10V		1	8	6	6	6	71-4706-00-00	
Optional IP66 IK09 box (300x200x105mm)								71-E100-00-00	

ⓘ P 906

	IP 66/67	IK 10	1000 Kg		SEA SIDE SUITABLE	BREEAM	
--	-------------	----------	---------	--	----------------------	--------	--

Model	W	K/ Cri/ Real lm	Optics	Source	Finishes
AL12 - 	18 18.3W	V9 2700K/CRI90 1301 lm	S2 16°	OU ON-OFF/100-277V 50-60Hz	Z5 ●
		W9 3000K/CRI90 1301 lm	M3 33°	DS DALI-2/220-240V 50-60Hz	
		X9 4000K/CRI90 1301 lm	F1 48°	XB CASAMBI 220-240V 50-60Hz	
				BB 26.5V/Max. 700mA	

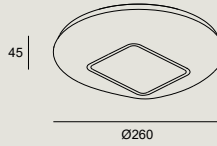
 45 | Ø260

AL12	IP		u. min			u. max			Code
			220-240V			110-127V			
IP68	ON-OFF		1	1	1	1	1	71-E015-00-00	
	DALI		1	1	1	1	1	71-E086-00-00	
	0-10V		1	1	1	1	1	71-E086-00-00	
IP20	ON-OFF		1	2	2	2	2	71-3542-00-00	
	DALI		1	2	2	2	2	71-4706-00-00	
	0-10V		1	2	2	2	2	71-4706-00-00	
Optional IP66 IK09 box (300x200x105mm)								71-E227-00-00	

ⓘ P 906

Solid

BODY MAT	DIF MAT		50000h	5
PC	PC		L80 B20	MacAdam



IP	IK	UGR		SEA SIDE SUITABLE	BREEAM
66	10	<19			

34 

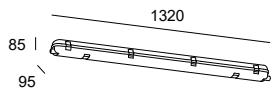



LED						
K	CRI	W LED	W Total	Real Lm	Code	
4000	80	27.4	30	2872	15-E000 15-E002 - 34 - CM 15-E004	
 220-240V 50-60Hz						

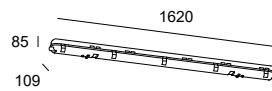

IP	IK	LOW FLICKER		SEA SIDE SUITABLE	BREEAM
66	10				

34 





LED						
K	CRI	W LED	W Total	Real Lm	Code	
4000	80	60	65	6082	15-E001	
4000	80	60	65	6082	15-E003 - 34 - CM	
4000	80	60	65	6404	15-E005	
 220-240V 50-60Hz						

Solid Emergency

BODY MAT	DIF MAT		50000h	5
PC	PC		L80 B20	MacAdam



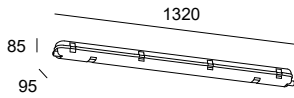

IP	IK	UGR		SEA SIDE		BREEAM
66	10	<19		SUITABLE	ON-OFF	

34 





LED K:4000 CRI:80 BATTERY:LiFePO4							
W	Real Lm	Real Lm. Em	H. emergency	Permanent	Auto test	Code	
27.4	2872	419	3	Yes	Yes	15-E006 - 34 - OE	
							
220-240V		50-60Hz					

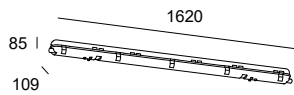

IP	IK	UGR	LOW		SEA SIDE		BREEAM
66	10	<22	FLICKER		SUITABLE	ON-OFF	

34 



LED K:4000 CRI:80 BATTERY:LiFePO4							
W	Real Lm	Real Lm. Em	H. emergency	Permanent	Auto test	Code	
60	6082	434	3	Yes	Yes	15-E007 - 34 - OE	
							
220-240V		50-60Hz					

Afrodita

BODY MAT
AL

DIF MAT
GLA



IP
54

SEA SIDE
SUITABLE

14  34  Z5 

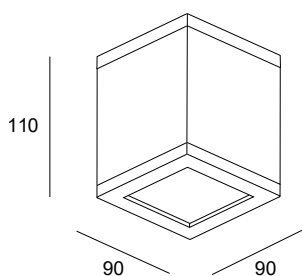

GU10	
W	Code
max. 35	14 15-9480 - 34 - 37 Z5

Kössel

BODY MAT	DIF MAT	
PC+ABS	PC	



IP	IK	SEASIDE
66	10	SUITABLE

34 

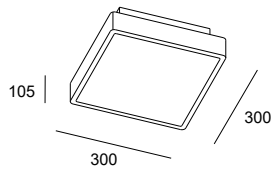



E27	
W	Code
2 x max. 18	15-9619 - 34 - M1

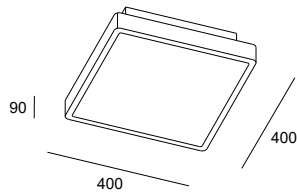

IP	IK	50000h	3	UGR	SEA SIDE		BREEAM
66	10	L80 B20	MacAdam	<16	SUITABLE	ON-OFF	

34 



LED					
K	CRI	W LED	W Total	Real Lm	Code
3000	80	19	20.1	1172	15-9806 - 34 - CL
	100-240V 50-60Hz				

Basic

BODY MAT	DIF MAT
AL	PC



NEW		IP 66	IK 10	SEA SIDE SUITABLE
-----	--	----------	----------	----------------------

14* ○ 34* ● 60* ● DL* ● E3* ● J6* ● Z5 ●

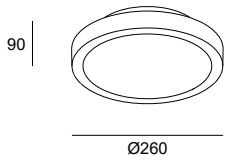

E27		
W	W Total	Code
		14
		34
		60
23	23	15-9835 - DL - M1
		E3
		J6
		Z5



NEW		IP 66	IK 10	50000h L80 B20	3 MacAdam	UGR <22	SEA SIDE SUITABLE	ON-OFF	BREEAM
-----	--	----------	----------	-------------------	--------------	------------	----------------------	--------	--------

SWITCH CCT
SW 2700-3200-4000

14* ○ 34* ● 60* ● DL* ● E3* ● J6* ● Z5 ●

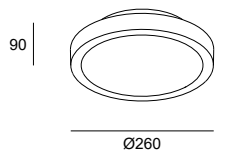

LED					
K	CRI	W LED	W Total	Real Lm	Code
					14
					34
					60
SW 2700-3200-4000	80	11.7	13.5	1269	15-E049 - DL - EH
					E3
					J6
					Z5
220-240V		50-60Hz			

*Fragen Sie unser Verkaufsteam nach den Lieferbedingungen.

Consultare i termini e le condizioni di consegna al nostro team commerciale.

Basic

BODY MAT	DIF MAT
AL	PC



NEW		IP 66	IK 10	SEA SIDE SUITABLE
-----	--	----------	----------	----------------------

14* 34* 60* DL* E3* J6* Z5

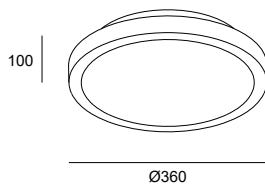

E27		
W	W Total	Code
15;15	30	14 34 60 15-E041 - DL - M1 E3 J6 Z5



NEW		IP 66	IK 10	50000h L80 B20	3 MacAdam	UGR <22	LOW FLICKER	SEA SIDE SUITABLE	
BREEAM	SWITCH CCT SW 2700-3200-4000								

14* 34* 60* DL* E3* J6* Z5

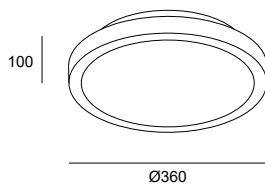

LED					
K	CRI	W LED	W Total	Real Lm	Code
SW 2700-3200-4000	80	21.4	24	2606	14 34 60 15-E050 - DL - EH E3 J6 Z5
220-240V		50-60Hz			

*Fragen Sie unser Verkaufsteam nach den Lieferbedingungen.
Consultare i termini e le condizioni di consegna al nostro team commerciale.



Chillout

Chillout

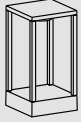

Rack

861

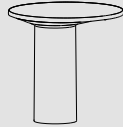

Moal

881

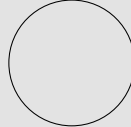

Cisne

884



Barcino

887

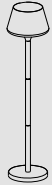

Moonlight

887



Rack

Table lamp



100 x 100 x 270 mm

Rechargeable

- 14
- 34
- 60
- DL
- E3
- J6
- Z5

Bollard



150 x 150 x 160 mm



150 x 150 x 300 mm



260 x 260 x 300 mm



150 x 150 x 700 mm



260 x 260 x 900 mm

Fixed - Plug&Play
Rechargeable

- 14
- 34
- 60
- DL
- E3
- J6
- Z5



Floor lamp



260 x 260 x 1800 mm

Fixed - Plug&Play
Rechargeable

- 14
- 34
- 60
- DL
- E3
- J6
- Z5



Wall fixtures



150 x 150 x 160 mm



150 x 150 x 300 mm

Fixed

- 14
- 34
- 60
- DL
- E3
- J6
- Z5



Rack

LUCA TURRINI 2022

50000h	3
L80 B20	MacAdam



Eleganz und geschmackvolle Präsenz sind die Merkmale dieser neuen Outdoor-Kollektion mit ausgeprägt dekorativem Charakter. Mit zahlreichen Optionen und unterschiedlichen Ausführungen ist die große Rack-Familie vielseitig einsetzbar und damit ideal für die Beleuchtung von Chillout-Bereichen mit unterschiedlichen Atmosphären. Dabei bietet sie mit einer hohen Stoßfestigkeit (IK10) und Hochdruckwasserbeständigkeit (IP66) Leistungsmerkmale, die auf die Anforderungen in Einzelhandel und Hotelgewerbe zugeschnitten sind. Diese Merkmale machen die RACK-Kollektion zum umfangreichsten professionell-dekorativen Leuchtenprogramm auf dem Markt. Eleganza e presenza con gusto sono le caratteristiche di questa nuova collezione outdoor, dotata di una forte personalità decorativa. Rack vanta una famiglia numerosa e una grande modularità, grazie alle sue varie opzioni e finiture, che le consentono di adattarsi a tutte le necessità in zone chillout con vari ambienti. E il tutto senza rinunciare alle elevate prestazioni richieste dal settore retail o alberghiero, come un'elevata resistenza agli urti (IK10) e all'acqua ad alta pressione (IP66). Queste caratteristiche fanno sì che RACK sia la collezione professionale-decorativa più ampia del mercato.



Rack fest montiert oder mobil Rack fisso o portatile

Rack ist in zwei Versionen erhältlich: als feste montierte Wand- oder Bodenvariante und als mobile Variante mit Akku oder Netzkabel. Das mobile Modell ist zudem mit Transportrollen, Design Philip Stark, und mit einem Diebstahlsicherungsseil erhältlich.

Rack è disponibile in due versioni: l'opzione fissa da parete o pavimento con perni, e l'opzione portatile ricaricabile con batteria o cavo e spina. Il modello portatile è inoltre disponibile con ruote, disegnate da Philip Stark, e con un accessorio di cavo antifurto.

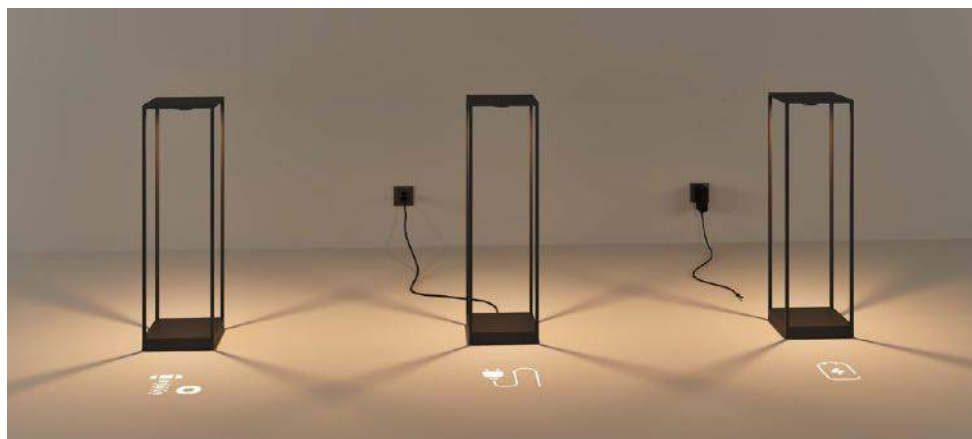

Verschiedene Ausführungen, gemeinsames Erscheinungsbild Varie opzioni, estetica comune

Die acht verschiedenen Ausführungen der Rack-Kollektion weisen ein gemeinsames Erscheinungsbild auf, das sich konsequent von den Tischleuchten über die Wand- und Standmodelle bis hin zu den Leuchtpfosten durchzieht und so die gewünschte Homogenität des beleuchteten Raums gewährleistet. Alle Modelle verfügen über dekorative Seitenabdeckungen, eine austauschbare obere Abdeckung in trendiger Holz- oder Zementoptik und die Möglichkeit, das schwarze Standardfinish auf Anfrage in verschiedenen anderen Farben zu gestalten. Darüber hinaus sind die meisten Ausführungen mit einem opalisierten Kugeldiffusor kombinierbar, um eine diffuseres Licht zu erzeugen.

La collezione Rack si presenta con un'estetica comune nelle 8 versioni disponibili, sia nei modelli da tavolo, che nelle applique, nelle piantane e nei faretti, con il fine di ottenere un'apprezzata omogeneità nello stesso ambiente. In ogni caso, dispone di coperchi decorativi laterali, un coperchio superiore intercambiabile con due finiture di tendenza disponibili: legno e cemento e opzione vari colori, nero di serie e il resto su richiesta. Inoltre, la maggior parte delle versioni sono compatibili con un diffusore sferico opalizzato per ricreare una luce più diffusa.



Farbtemperaturen Temperature di colore

Die Anpassung der Farbtemperatur an das gewünschte Ambiente ist für ein perfektes Lichtelebnis unerlässlich. Rack wird mit den Farbtemperaturen 2700K / 3000K / 4000K geliefert, die leicht über den eingebauten CCT-Switch umgestellt werden können.

Regolare la temperature di colore in funzione dell'ambiente desiderato è essenziale per vivere un'esperienza di illuminazione perfetta. Rack dispone di un ventaglio di temperature 2700K / 3000K / 4000K facilmente modificabili attraverso uno Switch CCT incorporato.



Verfügbare Farben Colori disponibili

Rack wird standardmäßig in der Schwarz geliefert und ist außerdem in dem Farbtönen der individuellen Farbpalette The Colours von LEDS C4 erhältlich.

Rack è disponibile nel colore nero di serie e anche nella gamma personalizzata The Colours di LEDS C4.



Smart

Einige Rack-Modelle sind mit einem Bluetooth-Mesh-Gerät und Casambi-Technologie ausgestattet, mit dem Sie verschiedene Atmosphären erzeugen und einzigartige Räume schaffen können.

In alcune versioni, la collezione Rack integra un dispositivo Bluetooth Mesh con tecnologia Casambi che consente di generare atmosfere diverse e creare spazi unici.

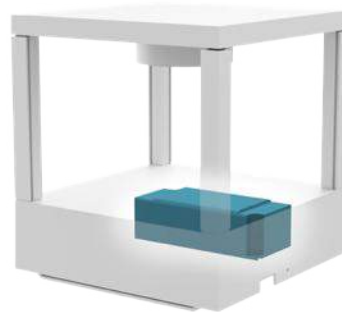

Smart-Funktionen: Lichtatmosphären Funzionalità Smart: Atmosfera luminosa

Die Smart-Technologie der Rack-Kollektion ermöglicht die Regelung der Lichtstärke und die Erzeugung dynamischer und flexibler, perfekt auf die Raumbedingungen abgestimmter Atmosphären.

La tecnologia Smart nella collezione Rack consente di regolare il livello luminoso e di ottenere atmosfere diverse in funzione delle esigenze dello spazio, offrendo così molto dinamismo e flessibilità.



RACK

Rack Table Lamp Rechargeable

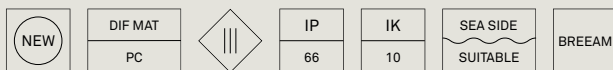

14* 34* 60 DL* E3* J6* Z5*



10-E001 10-E002 10-E003

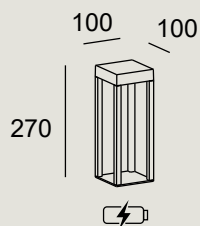

LED						
K	CRI	W LED	W Total	Real Lm	Code	
2700	80	1.5	1.5	88	14	
					34	
					60	10-E001
					DL - CK	10-E002
					E3	10-E003
3000	80	1.5	1.5	88	J6	
					Z5	
					14	
					34	
					60	10-E001
DL - CL	10-E002					
E3	10-E003					
4000	80	1.5	1.5	88	J6	
					Z5	
					14	
					34	
					60	10-E001
DL - CM	10-E002					
E3	10-E003					

5VDC 1000mA → 100% 6H 50% 12H 10% 60H

nicht inklusive / Non incluso	
Ladegerät Mehrfach Caricatore multipla	71-8332-05-00
Satz 4 x Zierabdeckungen weiß Set 4 x coperchi decorativi bianchi	71-E294-14-00
Satz 4 x Zierabdeckungen grau Set 4 x coperchi decorativi grigi	71-E294-34-00
Satz 4 x Zierabdeckungen schwarz Set 4 x coperchi decorativi neri	71-E294-60-00
Satz 4 x Zierabdeckungen gold Set 4 x coperchi decorativi dorati	71-E294-DL-00
Satz 4 x Zierabdeckungen tannengrün Set 4 x coperchi decorativi verde abete	71-E294-E3-00
Satz 4 x Zierabdeckungen braun Set 4 x coperchi decorativi marroni	71-E294-J6-00
Satz 4 x Zierabdeckungen hellgrau Set 4 x coperchi decorativi grigio chiaro	71-E294-Z5-00
Einzelladegerät Caricatore singolo	71-E367-60-00
Zugentlastungssatz wiederaufladbare Leuchte Kit anti-tiro per lampada ricaricabile	71-E293-00-00

*Fragen Sie unser Verkaufsteam nach den Lieferbedingungen.

Consultare i termini e le condizioni di consegna al nostro team commerciale.

RACK

Rack Bollard Fixed



DIF MAT
GLA



IP
66

IK
06

2 m

SEA SIDE
SUITABLE

BREEAM

SWITCH CCT
SW 2700-3200-4000



14* 34* 60 DL* E3* J6* Z5*

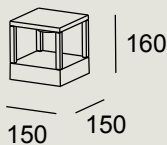

LED						
K	CRI	W LED	W Total	Real Lm	Code	
					14	
					34	
SW 2700-3200-4000	80	13.5	14.9	760	05-E071	60 DU
					05-E076	DL - OU
					05-E077	E3 XB
					J6	
					Z5	
DU	DALI	100-277V	50-60Hz			
OU	ON-OFF	100-277V	50-60Hz			
XB	Casambi	220-240V	50-60Hz			

nicht inklusive / Non incluso	
IP68-Stecker mit 6 Eingängen Connettore IP68 a 6 ingressi	71-9199-05-05
IP68- Antikondensationsstecker mit 2 Eingängen Connettore IP68 con valvola anticondensa a 2 ingressi	71-E112-00-00
IP68- Antikondensationsstecker mit 4 Eingängen Connettore IP68 con valvola anticondensa a 4 ingressi	71-E122-00-00
Satz 4 x Zierabdeckungen weiß Set 4 x coperchi decorativi bianchi	71-E278-14-00
Satz 4 x Zierabdeckungen grau Set 4 x coperchi decorativi grigi	71-E278-34-00
Satz 4 x Zierabdeckungen schwarz Set 4 x coperchi decorativi neri	71-E278-60-00
Satz 4 x Zierabdeckungen gold Set 4 x coperchi decorativi dorati	71-E278-DL-00
Satz 4 x Zierabdeckungen tannengrün Set 4 x coperchi decorativi verde abete	71-E278-E3-00
Satz 4 x Zierabdeckungen braun Set 4 x coperchi decorativi marroni	71-E278-J6-00
Satz 4 x Zierabdeckungen hellgrau Set 4 x coperchi decorativi grigio chiaro	71-E278-Z5-00
IP67-Stecker mit 5 Eingängen Connettore IP68 5 ingressi	71-E361-00-00

*Fragen Sie unser Verkaufsteam nach den Lieferbedingungen.
Consultare i termini e le condizioni di consegna al nostro team commerciale.

RACK

Rack Bollard Plug&Play

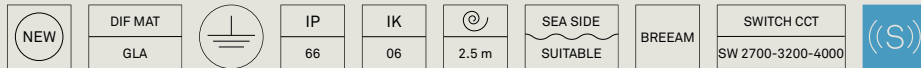

14* 34* 60 DL* E3* J6* Z5*



10-E007 10-E008 10-E009

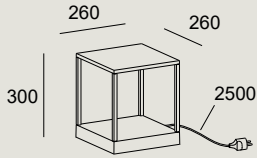

LED						
K	CRI	W LED	W Total	Real Lm	Code	
SW 2700-3200-4000	80	13.5	14.9	760	14	
					34	
					60	10-E007 - DL - OU
					E3	10-E008 - DL - XB
					J6	
Z5						
	OU	ON-OFF	100-277V	50-60Hz		
	XB	Casambi	220-240V	50-60Hz		

nicht inklusive / Non incluso	
Rollen Ruote	71-E292-60-00
Befestigungssystem für Rasen 26 x 26 mm Sistema di fissaggio per prato 26x26mm	71-E358-60-00

RACK

Rack Bollard Rechargeable

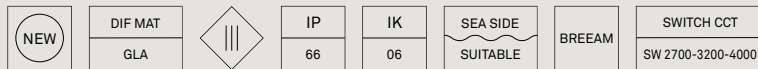

14* 34* 60 DL* E3* J6* Z5*



10-E014 10-E015 10-E017

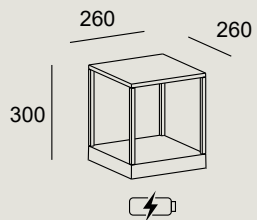

LED						
K	CRI	W LED	W Total	Real Lm	Code	
SW 2700-3200-4000	80	3	3	174	14	
					34	
					60	10-E014 - DL - EH
					E3	10-E015 - DL - EH
					J6	
Z5						
	5VDC 1000mA	13H	→	100% 12H	50% 30H	10% 100H

nicht inklusive / Non incluso	
Ladegerät Mehrfach Caricatore multipla	71-8332-05-00
Rollen Ruote	71-E292-60-00
Befestigungssystem für Rasen 26 x 26 mm Sistema di fissaggio per prato 26x26mm	71-E358-60-00
Einzelladegerät Caricatore singolo	71-E367-60-00
Zugentlastungssatz wiederaufladbare Leuchte Kit anti-tiro per lampada ricaricabile	71-E293-00-00

*Fragen Sie unser Verkaufsteam nach den Lieferbedingungen.
Consultare i termini e le condizioni di consegna al nostro team commerciale.

RACK

Rack Bollard Fixed



DIF MAT
GLA



IP
66

IK
06

2 m

SEA SIDE
SUITABLE

BREEAM

SWITCH CCT
SW 2700-3200-4000



14* 34* 60 DL* E3* J6* Z5*

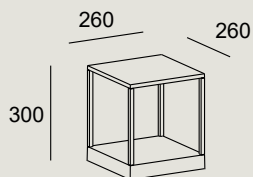

LED						
K	CRI	W LED	W Total	Real Lm	Code	
SW 2700-3200-4000	80	13.5	14.9	760	14	
					34	
					60	DU
					55-E063 - DL -	OU
					55-E065 E3	XB
					J6	
					Z5	
	DU	DALI	100-277V	50-60Hz		
	OU	ON-OFF	100-277V	50-60Hz		
	XB	Casambi	220-240V	50-60Hz		

nicht inklusive / Non incluso

IP68-Stecker mit 6 Eingängen Connettore IP68 a 6 ingressi	71-9199-05-05
Pflock 235 mm Paletto 235mm	71-9997-05-05
Pflock 302mm Paletto 302mm	71-9998-05-05
IP68- Antikondensationsstecker mit 2 Eingängen Connettore IP68 con valvola anticondensa a 2 ingressi	71-E112-00-00
IP68- Antikondensationsstecker mit 4 Eingängen Connettore IP68 con valvola anticondensa a 4 ingressi	71-E122-00-00
IP67-Stecker mit 5 Eingängen Connettore IP68 5 ingressi	71-E361-00-00

nicht mitgeliefertes
allgemeines Zub.
Access. comuni non inclusi

Satz 4 x Zierabdeckungen weiß Set 4 x coperchi decorativi bianchi	71-E281-14-00
Satz 4 x Zierabdeckungen grau Set 4 x coperchi decorativi grigi	71-E281-34-00
Satz 4 x Zierabdeckungen schwarz Set 4 x coperchi decorativi neri	71-E281-60-00
Satz 4 x Zierabdeckungen gold Set 4 x coperchi decorativi dorati	71-E281-DL-00
Satz 4 x Zierabdeckungen tannengrün Set 4 x coperchi decorativi verde abete	71-E281-E3-00
Satz 4 x Zierabdeckungen braun Set 4 x coperchi decorativi marroni	71-E281-J6-00
Satz 4 x Zierabdeckungen hellgrau Set 4 x coperchi decorativi grigio chiaro	71-E281-Z5-00
Kugeldiffusor aus Opalglas Diffusore sferico di vetro opal	71-E284-60-F9

*Fragen Sie unser Verkaufsteam nach den Lieferbedingungen.
Consultare i termini e le condizioni di consegna al nostro team commerciale.

RACK

Rack Bollard Plug&Play

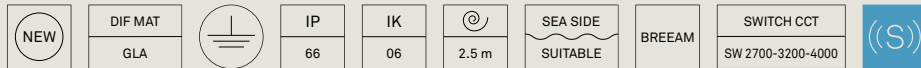

14* 34* 60 DL* E3* J6* Z5*

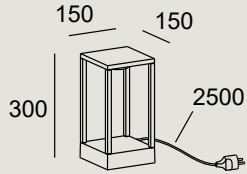

LED						
K	CRI	W LED	W Total	Real Lm	Code	
SW 2700-3200-4000	80	13.5	14.9	760	14	
					34	
					60	OU
					DL -	XB
					E3	
					J6	
					Z5	
	OU	ON-OFF	100-277V	50-60Hz		
	XB	Casambi	220-240V	50-60Hz		

nicht inklusive / Non incluso

Befestigungssystem für Rasen 15 x 15 mm
Sistema di fissaggio per prato 15x15mm

71-E357-60-00

RACK

Rack Bollard Rechargeable

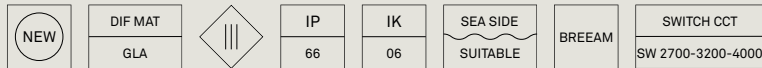

14* 34* 60 DL* E3* J6* Z5*

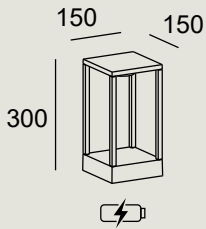

LED						
K	CRI	W LED	W Total	Real Lm	Code	
SW 2700-3200-4000	80	3	3	174	14	
					34	
					60	DL -
					E3	EH
						J6
					Z5	
	5VDC 1000mA			13H	→ 100% 12H	50% 30H 10% 100H

nicht inklusive / Non incluso

Ladegerät Mehrfach
Caricatore multipla

71-8332-05-00

Befestigungssystem für Rasen 15 x 15 mm
Sistema di fissaggio per prato 15x15mm

71-E357-60-00

Einzelladegerät
Caricatore singolo

71-E367-60-00

Zugentlastungssatz wiederaufladbare Leuchte
Kit anti-tiro per lampada ricaricabile

71-E293-00-00

*Fragen Sie unser Verkaufsteam nach den Lieferbedingungen.

Consultare i termini e le condizioni di consegna al nostro team commerciale.

RACK

Rack Bollard Fixed

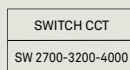

14* 34* 60 DL* E3* J6* Z5*

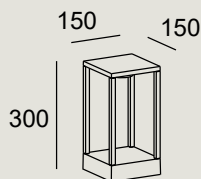

LED						
K	CRI	W LED	W Total	Real Lm	Code	
SW 2700-3200-4000	80	13.5	14.9	760	14	
					34	
					60	DU
					55-E057 - DL -	OU
					55-E059 E3	XB
					J6	
					Z5	
DU	DALI	100-277V	50-60Hz			
OU	ON-OFF	100-277V	50-60Hz			
XB	Casambi	220-240V	50-60Hz			

nicht inklusive / Non incluso	
IP68-Stecker mit 6 Eingängen Connettore IP68 a 6 ingressi	71-9199-05-05
Pflock 235 mm Paletto 235mm	71-9997-05-05
Pflock 302mm Paletto 302mm	71-9998-05-05
IP68- Antikondensationsstecker mit 2 Eingängen Connettore IP68 con valvola anticondensa a 2 ingressi	71-E112-00-00
IP68- Antikondensationsstecker mit 4 Eingängen Connettore IP68 con valvola anticondensa a 4 ingressi	71-E122-00-00
IP67-Stecker mit 5 Eingängen Connettore IP68 5 ingressi	71-E361-00-00

nicht mitgeliefertes allgemeines Zub. Access. comuni non inclusi	Satz 4 x Zierabdeckungen weiß Set 4 x coperchi decorativi bianchi	71-E279-14-00
	Satz 4 x Zierabdeckungen grau Set 4 x coperchi decorativi grigi	71-E279-34-00
	Satz 4 x Zierabdeckungen schwarz Set 4 x coperchi decorativi neri	71-E279-60-00
	Satz 4 x Zierabdeckungen gold Set 4 x coperchi decorativi dorati	71-E279-DL-00
	Satz 4 x Zierabdeckungen tannengrün Set 4 x coperchi decorativi verde abete	71-E279-E3-00
	Satz 4 x Zierabdeckungen braun Set 4 x coperchi decorativi marroni	71-E279-J6-00
	Satz 4 x Zierabdeckungen hellgrau Set 4 x coperchi decorativi grigio chiaro	71-E279-Z5-00
	Kugeldiffusor aus Opalglas Diffusore sferico di vetro opal	71-E284-60-F9

*Fragen Sie unser Verkaufsteam nach den Lieferbedingungen.
Consultare i termini e le condizioni di consegna al nostro team commerciale.

RACK

Rack Bollard Plug&Play

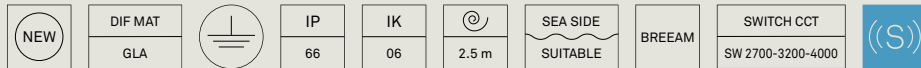

14* ○ 34* ● 60 ● DL* ● E3* ● J6* ● Z5* ●

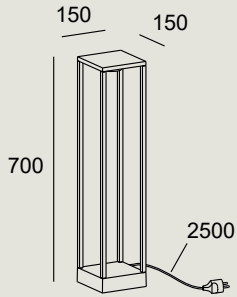

LED						
K	CRI	W LED	W Total	Real Lm	Code	
SW 2700-3200-4000	80	13.5	14.9	760	14	
					34	
					60	
					25-E006	DL - OU
					25-E007	DL - XB
25-E008	E3					
					J6	
					Z5	

	OU	ON-OFF	100-277V	50-60Hz		
	XB	Casambi	220-240V	50-60Hz		

nicht inklusive / Non incluso

Befestigungssystem für Rasen 15 x 15 mm
Sistema di fissaggio per prato 15x15mm

71-E357-60-00

RACK

Rack Bollard Rechargeable

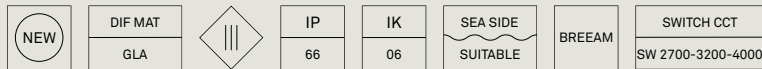

14* ○ 34* ● 60 ● DL* ● E3* ● J6* ● Z5* ●

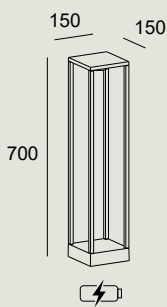

LED						
K	CRI	W LED	W Total	Real Lm	Code	
SW 2700-3200-4000	80	3	3	174	14	
					34	
					60	
					25-E009	DL - EH
					25-E010	E3
25-E011	E3					
					J6	
					Z5	

5VDC 1000mA	13H	→	100% 12H	50% 30H	10% 100H	
-------------	-----	---	----------	---------	----------	--

nicht inklusive / Non incluso

Ladegerät Mehrfach
Caricatore multipla

71-8332-05-00

Befestigungssystem für Rasen 15 x 15 mm
Sistema di fissaggio per prato 15x15mm

71-E357-60-00

Einzelladegerät
Caricatore singolo

71-E367-60-00

Zugentlastungssatz wiederaufladbare Leuchte
Kit anti-tiro per lampada ricaricabile

71-E293-00-00

*Fragen Sie unser Verkaufsteam nach den Lieferbedingungen.

Consultare i termini e le condizioni di consegna al nostro team commerciale.

RACK

Rack Bollard Fixed



14* 34* 60 DL* E3* J6* Z5*

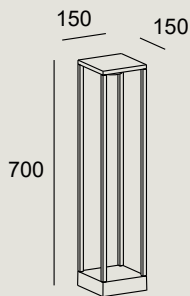

LED						
K	CRI	W LED	W Total	Real Lm	Code	
SW 2700-3200-4000	80	13.5	14.9	760	14	
					34	
					60	DU
					55-E061	DL - OU
					55-E062	E3 XB
					J6	
					Z5	
DU DALI 100-277V 50-60Hz						
OU ON-OFF 100-277V 50-60Hz						
XB Casambi 220-240V 50-60Hz						

nicht inklusive / Non incluso

IP68-Stecker mit 6 Eingängen Connettore IP68 a 6 ingressi	71-9199-05-05
Pflock 235 mm Paletto 235mm	71-9997-05-05
Pflock 302mm Paletto 302mm	71-9998-05-05
IP68- Antikondensationsstecker mit 2 Eingängen Connettore IP68 con valvola anticondensa a 2 ingressi	71-E112-00-00
IP68- Antikondensationsstecker mit 4 Eingängen Connettore IP68 con valvola anticondensa a 4 ingressi	71-E122-00-00
IP67-Stecker mit 5 Eingängen Connettore IP68 5 ingressi	71-E361-00-00

nicht mitgeliefertes
allgemeines Zub.
Access. comuni non inclusi

Satz 4 x Zierabdeckungen weiß Set 4 x coperchi decorativi bianchi	71-E280-14-00
Satz 4 x Zierabdeckungen grau Set 4 x coperchi decorativi grigi	71-E280-34-00
Satz 4 x Zierabdeckungen schwarz Set 4 x coperchi decorativi neri	71-E280-60-00
Satz 4 x Zierabdeckungen gold Set 4 x coperchi decorativi dorati	71-E280-DL-00
Satz 4 x Zierabdeckungen tannengrün Set 4 x coperchi decorativi verde abete	71-E280-E3-00
Satz 4 x Zierabdeckungen braun Set 4 x coperchi decorativi marroni	71-E280-J6-00
Satz 4 x Zierabdeckungen hellgrau Set 4 x coperchi decorativi grigio chiaro	71-E280-Z5-00
Kugeldiffusor aus Opalglas Diffusore sferico di vetro opal	71-E284-60-F9

*Fragen Sie unser Verkaufsteam nach den Lieferbedingungen.

Consultare i termini e le condizioni di consegna al nostro team commerciale.

RACK

Rack Bollard Plug&Play

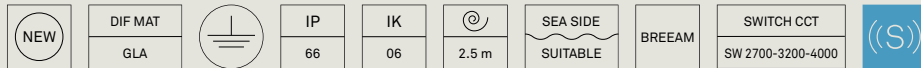

14* 34* 60 DL* E3* J6* Z5*

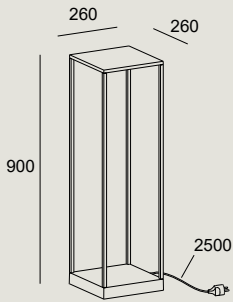

LED							
K	CRI	W LED	W Total	Real Lm	Code		
SW 2700-3200-4000	80	13.5	14.9	760	14		
					34		
					25-E000	60	OU
					25-E001 - DL -	E3	XB
					25-E002	J6	
					Z5		
	OU	ON-OFF	100-277V	50-60Hz			
	XB	Casambi	220-240V	50-60Hz			

nicht inklusive / Non incluso	
Rollen Ruote	71-E292-60-00
Befestigungssystem für Rasen 26 x 26 mm Sistema di fissaggio per prato 26x26mm	71-E358-60-00

RACK

Rack Bollard Rechargeable

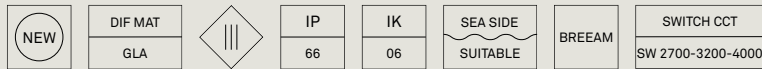

14* 34* 60 DL* E3* J6* Z5*

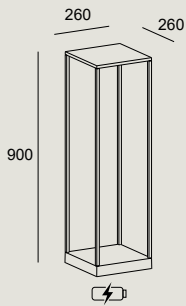

LED							
K	CRI	W LED	W Total	Real Lm	Code		
SW 2700-3200-4000	80	3	3	174	14		
					34		
					25-E012	60	EH
					25-E013 - DL -	E3	
					25-E014	J6	
					Z5		
	5VDC 1000mA			13H	→ 100% 12H	50% 30H	10% 100H

nicht inklusive / Non incluso	
Ladegerät Mehrfach Caricatore multipla	71-8332-05-00
Rollen Ruote	71-E292-60-00
Befestigungssystem für Rasen 26 x 26 mm Sistema di fissaggio per prato 26x26mm	71-E358-60-00
Einzelladegerät Caricatore singolo	71-E367-60-00
Zugentlastungssatz wiederaufladbare Leuchte Kit anti-tiro per lampada ricaricabile	71-E293-00-00

*Fragen Sie unser Verkaufsteam nach den Lieferbedingungen.
Consultare i termini e le condizioni di consegna al nostro team commerciale.

RACK

Rack Bollard Fixed

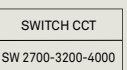

14* 34* 60 DL* E3* J6* Z5*

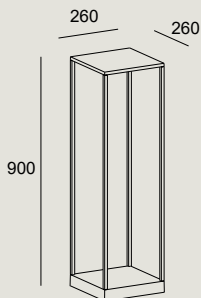

LED						
K	CRI	W LED	W Total	Real Lm	Code	
SW 2700-3200-4000	80	13.5	14.9	760	14	
					34	
					60	DU
					55-E066	DL - OU
					55-E067	DL - OU
					55-E068	E3 XB
					J6	
					Z5	

	DU	DALI	100-277V	50-60Hz
	OU	ON-OFF	100-277V	50-60Hz
	XB	Casambi	220-240V	50-60Hz

nicht inklusive / Non incluso

IP68-Stecker mit 6 Eingängen Connettore IP68 a 6 ingressi	71-9199-05-05
Pflock 235 mm Paletto 235mm	71-9997-05-05
Pflock 302mm Paletto 302mm	71-9998-05-05
IP68- Antikondensationsstecker mit 2 Eingängen Connettore IP68 con valvola anticondensa a 2 ingressi	71-E112-00-00
IP68- Antikondensationsstecker mit 4 Eingängen Connettore IP68 con valvola anticondensa a 4 ingressi	71-E122-00-00
IP67-Stecker mit 5 Eingängen Connettore IP68 5 ingressi	71-E361-00-00

nicht mitgeliefertes
allgemeines Zub.
Access. comuni non inclusi

Satz 4 x Zierabdeckungen weiß Set 4 x coperchi decorativi bianchi	71-E282-14-00
Satz 4 x Zierabdeckungen grau Set 4 x coperchi decorativi grigi	71-E282-34-00
Satz 4 x Zierabdeckungen schwarz Set 4 x coperchi decorativi neri	71-E282-60-00
Satz 4 x Zierabdeckungen gold Set 4 x coperchi decorativi dorati	71-E282-DL-00
Satz 4 x Zierabdeckungen tannengrün Set 4 x coperchi decorativi verde abete	71-E282-E3-00
Satz 4 x Zierabdeckungen braun Set 4 x coperchi decorativi marroni	71-E282-J6-00
Satz 4 x Zierabdeckungen hellgrau Set 4 x coperchi decorativi grigio chiaro	71-E282-Z5-00
Kugeldiffusor aus Opalglas Diffusore sferico di vetro opal	71-E284-60-F9

*Fragen Sie unser Verkaufsteam nach den Lieferbedingungen.
Consultare i termini e le condizioni di consegna al nostro team commerciale.

RACK

Rack Floor Lamp Plug&Play

	BODY MAT AL	DIF MAT GLA		IP 66	IK 06		SEA SIDE SUITABLE	BREEAM	SWITCH CCT SW 2700-3200-4000	
--	----------------	----------------	--	----------	----------	--	----------------------	--------	---------------------------------	--

14* 34* 60 DL* E3* J6* Z5*



25-E003

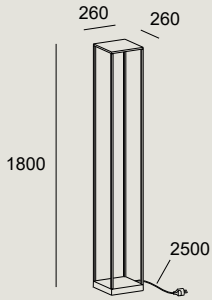

LED						
K	CRI	W LED	W Total	Real Lm	Code	
SW 2700-3200-4000	80	13.5	14.9	760	25-E003 - DL -	OU XB
						14 34 60 E3 J6 Z5
	ON-OFF	100-277V	50-60Hz			
	Casambi	220-240V	50-60Hz			

nicht inklusive / Non incluso

Pflock 235 mm Paletto 235mm	71-9997-05-05
Pflock 302mm Paletto 302mm	71-9998-05-05
Rollen Ruote	71-E292-60-00

RACK

Rack Floor Lamp Rechargeable

	BODY MAT AL	DIF MAT GLA		IP 66	IK 06	SEA SIDE SUITABLE	BREEAM	SWITCH CCT SW 2700-3200-4000
--	----------------	----------------	--	----------	----------	----------------------	--------	---------------------------------

14* 34* 60 DL* E3* J6* Z5*



25-E015

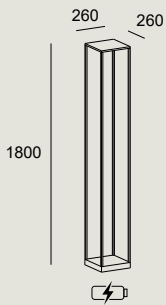

LED						
K	CRI	W LED	W Total	Real Lm	Code	
SW 2700-3200-4000	80	3	3	174	25-E015 - DL -	EH
						14 34 60 E3 J6 Z5
	5VDC 1000mA	13H	→	100% 12H	50% 30H	10% 100H

nicht inklusive / Non incluso

Ladegerät Mehrfach Caricatore multipla	71-8332-05-00
Pflock 235 mm Paletto 235mm	71-9997-05-05
Pflock 302mm Paletto 302mm	71-9998-05-05
Rollen Ruote	71-E292-60-00
Einzelladegerät Caricatore singolo	71-E367-60-00
Zugentlastungssatz wiederaufladbare Leuchte Kit anti-tiro per lampada ricaricabile	71-E293-00-00

*Fragen Sie unser Verkaufsteam nach den Lieferbedingungen.

Consultare i termini e le condizioni di consegna al nostro team commerciale.

RACK

Rack Floor Lamp Fixed



BODY MAT
AL

DIF MAT
GLA



IP
66

IK
06

⊙
2 m

SEA SIDE
SUITABLE

BREEAM

SWITCH CCT
SW 2700-3200-4000



14* 34* 60 DL* E3* J6* Z5*



55-E069

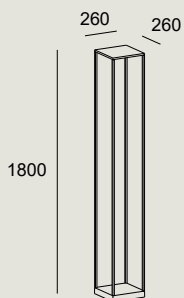

LED						
K	CRI	W LED	W Total	Real Lm	Code	
SW 2700-3200-4000	80	13.5	14.9	760	55-E069 -	14 34 60 DL - DU E3 - OU J6 Z5 XB
DU	DALI	100-277V	50-60Hz			
OU	ON-OFF	100-277V	50-60Hz			
XB	Casambi	220-240V	50-60Hz			

nicht inklusive / Non incluso

IP68-Stecker mit 6 Eingängen Connettore IP68 a 6 ingressi	71-9199-05-05
Pflock 235 mm Paletto 235mm	71-9997-05-05
Pflock 302mm Paletto 302mm	71-9998-05-05
IP68- Antikondensationsstecker mit 2 Eingängen Connettore IP68 con valvola anticondensa a 2 ingressi	71-E112-00-00
IP68- Antikondensationsstecker mit 4 Eingängen Connettore IP68 con valvola anticondensa a 4 ingressi	71-E122-00-00
IP67-Stecker mit 5 Eingängen Connettore IP68 5 ingressi	71-E361-00-00

nicht mitgeliefertes
allgemeines Zub.
Access. comuni non inclusi

Kugeldiffusor aus Opalglas
Diffusore sferico di vetro opal

71-E284-60-F9

*Fragen Sie unser Verkaufsteam nach den Lieferbedingungen.
Consultare i termini e le condizioni di consegna al nostro team commerciale.

RACK

Rack Wall Fixture



14* 34* 60 DL* E3* J6* Z5*



05-E071 05-E076 05-E077

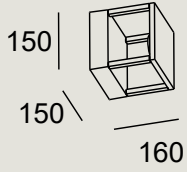

LED						
K	CRI	W LED	W Total	Real Lm	Code	
SW 2700-3200-4000	80	13.5	14.9	760	14	
					34	
					05-E071	60 DU
					05-E076	- DL - OU
					05-E077	E3 XB
					J6	
					Z5	

	DALI	100-277V	50-60Hz
	ON-OFF	100-277V	50-60Hz
	Casambi	220-240V	50-60Hz



nicht inklusive / Non incluso

IP68-Stecker mit 6 Eingängen Connettore IP68 a 6 ingressi	71-9199-05-05
IP68- Antikondensationsstecker mit 2 Eingängen Connettore IP68 con valvola anticondensa a 2 ingressi	71-E112-00-00
IP68- Antikondensationsstecker mit 4 Eingängen Connettore IP68 con valvola anticondensa a 4 ingressi	71-E122-00-00
Satz 4 x Zierabdeckungen weiß Set 4 x coperchi decorativi bianchi	71-E278-14-00
Satz 4 x Zierabdeckungen grau Set 4 x coperchi decorativi grigi	71-E278-34-00
Satz 4 x Zierabdeckungen schwarz Set 4 x coperchi decorativi neri	71-E278-60-00
Satz 4 x Zierabdeckungen gold Set 4 x coperchi decorativi dorati	71-E278-DL-00
Satz 4 x Zierabdeckungen tannengrün Set 4 x coperchi decorativi verde abete	71-E278-E3-00
Satz 4 x Zierabdeckungen braun Set 4 x coperchi decorativi marroni	71-E278-J6-00
Satz 4 x Zierabdeckungen hellgrau Set 4 x coperchi decorativi grigio chiaro	71-E278-Z5-00
IP67-Stecker mit 5 Eingängen Connettore IP68 5 ingressi	71-E361-00-00

*Fragen Sie unser Verkaufsteam nach den Lieferbedingungen.

Consultare i termini e le condizioni di consegna al nostro team commerciale.

RACK

Rack Wall Fixture Fixed



14* 34* 60 DL* E3* J6* Z5*



05-E082 05-E088 05-E089

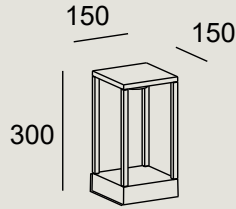

LED						
K	CRI	W LED	W Total	Real Lm	Code	
SW 2700-3200-4000	80	13.5	14.9	760	14	
					34	
					05-E082	60 DU
					05-E088	- DL - OU
					05-E089	E3 XB
					J6	
					Z5	

	DALI	100-277V	50-60Hz
	ON-OFF	100-277V	50-60Hz
	Casambi	220-240V	50-60Hz

nicht inklusive / Non incluso

IP68-Stecker mit 6 Eingängen Connettore IP68 a 6 ingressi	71-9199-05-05
IP68- Antikondensationsstecker mit 2 Eingängen Connettore IP68 con valvola anticondensa a 2 ingressi	71-E112-00-00
IP68- Antikondensationsstecker mit 4 Eingängen Connettore IP68 con valvola anticondensa a 4 ingressi	71-E122-00-00
Satz 4 x Zierabdeckungen weiß Set 4 x coperchi decorativi bianchi	71-E279-14-00
Satz 4 x Zierabdeckungen grau Set 4 x coperchi decorativi grigi	71-E279-34-00
Satz 4 x Zierabdeckungen schwarz Set 4 x coperchi decorativi neri	71-E279-60-00
Satz 4 x Zierabdeckungen gold Set 4 x coperchi decorativi dorati	71-E279-DL-00
Satz 4 x Zierabdeckungen tannengrün Set 4 x coperchi decorativi verde abete	71-E279-E3-00
Satz 4 x Zierabdeckungen braun Set 4 x coperchi decorativi marroni	71-E279-J6-00
Satz 4 x Zierabdeckungen hellgrau Set 4 x coperchi decorativi grigio chiaro	71-E279-Z5-00
Kugeldiffusor aus Opalglas Diffusore sferico di vetro opal	71-E284-60-F9
IP67-Stecker mit 5 Eingängen Connettore IP68 5 ingressi	71-E361-00-00

*Fragen Sie unser Verkaufsteam nach den Lieferbedingungen.

Consultare i termini e le condizioni di consegna al nostro team commerciale.





Moal

BODY MAT		50000h	3
AL / CON		L80 B20	MacAdam



Hoher visueller Komfort Alto comfort visivo

Moal ist ein Outdoor-Sortiment mit modernem und zeitlosem Design aus Zement. Es eignet sich perfekt, um Kompositionen zu schaffen und einen Raum auf ansprechende und einladende Weise zu beleuchten. Die Kollektion besteht aus einer Wandleuchte und zwei Bodenleuchten, die sogar als Möbelstücke verwendet werden können. Moal erzeugt mit seiner Präsenz und einem Spiel aus Licht und Schatten Kompositionen, die sich insbesondere für Terrassen und Gärten von Hotels eignen.

Moal è una collezione outdoor con un design contemporaneo e duraturo nel tempo, realizzata in cemento. È ideale per creare composizioni ed illuminare uno spazio in modo suggestivo e caldo. Si compone di una lampada da parete e due faretti che possono essere utilizzati anche come mobili da esterno. Concepito appositamente per essere collocato su terrazze e giardini di hotel, ristoranti o residence, Moal crea composizioni con la sua presenza ed il suo gioco di luci ed ombre.

Zur Erzielung eines hohen Sehkomforts sorgen der Anbau der LED an der Oberseite des Kopfteils und die Neigung des Diffusors dafür, dass der Lichtstrahl eine größere Fläche abdeckt und nach unten gelenkt wird, um jegliche Blendung komplett zu vermeiden.

Progettato per offrire un grande comfort visivo, il posizionamento dei LED nella parte superiore della testa, insieme all'inclinazione del diffusore, fanno sì che il fascio luminoso raggiunga un'area più ampia ed essere diretto verso il basso, evitando così qualsiasi bagliore.



Maximale Lebensdauer Massima durabilità

Die Ausführung in Beton und Aluminium maximiert die Lebensdauer in nassen Umgebungen und in direkter Meeresnähe. Dotato di un corpo in cemento e in alluminio per massimizzare la vita utile del prodotto, permettendo, inoltre, la sua installazione in ambienti umidi o anche sul lungomare.



Pro-Base-System Pro-base System



Die Bodenleuchten sind mit dem PRO-Base-System ausgestattet, das die Leuchte besonders stabil macht und es ermöglicht, sie problemlos als Sitzgelegenheit oder Tisch mit einer Belastbarkeit von bis zu 180 kg zu verwenden. 100 % integriert. Der Sockel ist vollständig in der Leuchte verborgen. 100 % geschützt. Mit Technopolymerschicht, die den Sockel vor direktem Kontakt mit dem Boden isoliert und so ein Verkratzen des Aluminiums während der Installation verhindert. 100 % stabil. Der Sockel besteht aus besonders dickem Aluminium, um Schwachstellen zu vermeiden, und kann in privaten, öffentlich genutzten Bereichen wie Einkaufszentren oder Hotels installiert werden.

100 % zur Verwendung direkt am Meer geeignet. Die äußere Aluminiumschicht wird durch ein spezielles Verfahren verstärkt, das die Oxidation des Aluminiums verhindert.

100 % gerade. Mit drei zusätzlichen Löchern, die dafür sorgen, dass alle Bodenaufbauleuchten während der Installation absolut gerade sind, ohne jegliche Neigung.

I faretto sono dotati del sistema Pro-base per garantire un'ulteriore robustezza della luminaria e consentire l'utilizzo del prodotto come sedile o tavolo, con una resistenza fino a 180Kg, senza problemi. Integrato al 100%.

Base totalmente nascosta all'interno del faretto.

Protetto al 100%. È inclusa una piastra in tecnopolimero per isolare la base dal contatto diretto a terra, evitando, in questo modo, eventuali graffi sull'alluminio, durante l'installazione.

Stabile al 100%. Base realizzata in alluminio con spessore superiore per evitare punti deboli e per permettere la sua installazione in aree private di uso pubblico, come centri commerciali o hotel.

Adatto al 100% per il lungomare. Processo di fabbricazione speciale per rinforzare lo strato esterno dell'alluminio, evitando così la sua ossidazione.

100% dritto. Sono inclusi 3 fori extra per facilitare il montaggio ed assicurare che i paletti rimangano assolutamente dritti durante l'installazione, senza alcuna inclinazione.

Einfache Installation Installazione facile

Doppelter Kabeleingang, um die Installation in Reihe zu vereinfachen.

Include un doppio ingresso dei cavi per favorire l'installazione a catena.



MOAL

Moal Wall Fixture

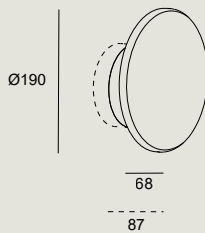

DIF MAT	IP	IK	LOW		SEA SIDE	
PMMA	65	10	FLICKER		SUITABLE	ON-OFF

DC

LED						
K	CRI	W LED	W Total	Real Lm	Code	
3000	80	8.2	11.1	312	05-E087 - DC - CL	
100-240V		50-60Hz				

inklusive / Incluso

Anheber zum Übereinanderschieben von Leuchten
Dispositivo per unire le luci e allungarle

MOAL

Moal Bollard

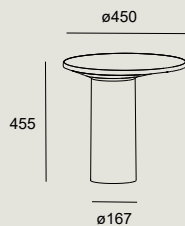

DIF MAT	IP	IK		SEA SIDE		
PC	66	10		SUITABLE	PRO-BASE	ON-OFF

DC

LED						
K	CRI	W LED	W Total	Real Lm	Code	
3000	80	13.7	16.3	729	55-E087 - DC - CL	
100-240V		50-60Hz				

DIF MAT	IP	IK		SEA SIDE		
PC	66	10		SUITABLE	PRO-BASE	ON-OFF

DC

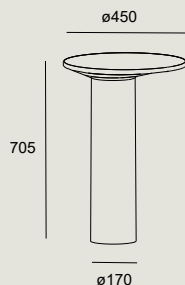

LED						
K	CRI	W LED	W Total	Real Lm	Code	
3000	80	13.7	16.3	729	55-E088 - DC - CL	
100-240V		50-60Hz				

nicht mitgeliefertes
allgemeines Zub.
Access. comuni non inclusi

Bodenbefestigungsschrauben
Bulloni di fissaggio a pavimento

71-E157-00-00



Cisne Pendant

BODY MAT	DIF MAT	
PC	PMMA	



IP	IK	SEA SIDE	BREEAM	(SC)
44	06	SUITABLE		

14 

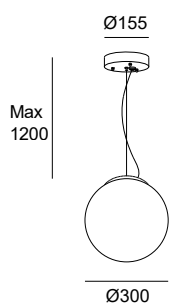

E27		
	W max. 23	Code 00-9155 - 14 - M1



IP	IK	SEA SIDE	BREEAM	(SC)
44	06	SUITABLE		

14 

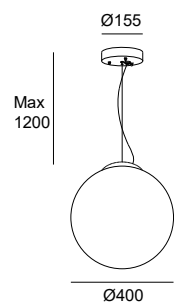

E27		
	W max. 30	Code 00-9156 - 14 - M1

mitgeliefertes allgemeines Zub. Erdspieß
Access. comuni inclusi Picchetto

Smart Compatible-Zub.
Access. Smart Compatibile

E27 RGBW Light For Life WIFI
E27 TW Casambi

71-8219-00-00
71-A697-00-00

Cisne Surface

BODY MAT	DIF MAT	
PC	PMMA	



IP	IK	SEA SIDE	BREEAM	(SC)
44	06	SUITABLE		

M1

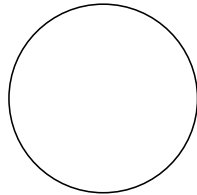

Ø300

E27	
W	Code
max. 23	55-9155 - M1 - M1



IP	IK	SEA SIDE	BREEAM	(SC)
44	06	SUITABLE		

M1

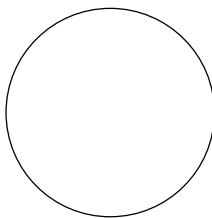

Ø400

E27	
W	Code
max. 30	55-9156 - M1 - M1

mitgeliefertes allgemeines Zub. Erdspieß
Access. comuni inclusi Picchetto

Smart Compatible-Zub.
Access. Smart Compatibile

E27 RGBW Light For Life WIFI
E27 TW Casambi

71-8219-00-00
71-A697-00-00



Cisne Surface

BODY MAT	DIF MAT	
PC	PMMA	



IP	IK	SEA SIDE	BREEAM	(SC)
44	06	SUITABLE		

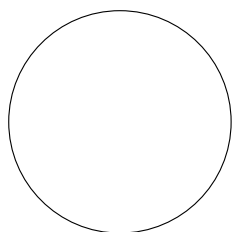

Ø500

M1 



E27	
W max. 30	Code 55-9481 - M1 - M1



Barcino

BODY MAT	DIF MAT	
AL	PLABS	



IP	IK		SEA SIDE	
65	10	5 m	SUITABLE	

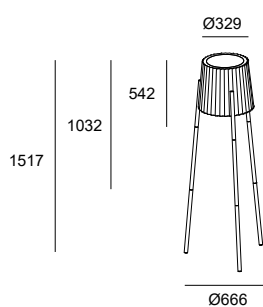

Z5 ●

E27		
W	W Total	Code
100	100	55-9880 - Z5 - M1

Smart Compatible-Zub. / Access. Smart Compatibile

71-8219-00-00 E27 RGBW Light For Life WIFI

71-A697-00-00 E27 TW Casambi

Moonlight

BODY MAT	
AL	



IP	IK		SEA SIDE
44	08	5 m	SUITABLE

Z5 ●

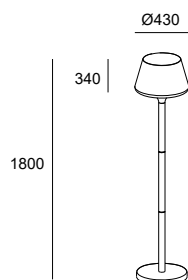

E27		
W	W Total	Code
30	30	25-9503 - Z5 - M1

inklusive / Incluso

Socket für die Aufputzanbringung
Base per fissaggio in superficie

Opakem Schirm
Schermo opaco

EMERGENCY

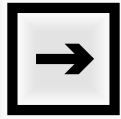

Notfallbeleuchtung
Apparecchi di
emergenza
891



Technische
Notbeleuchtung
Illuminazione
tecnica di emergenza
916



Notbeleuchtung

Illuminazione di emergenza

Was ist Notbeleuchtung?

Notbeleuchtung spielt wie auch technische oder dekorative Beleuchtung eine sehr wichtige Rolle für die Sicherheit und das Wohlbefinden der Menschen. Sie ist ein unverzichtbares und vorgeschriebenes Element, das uns im Notfall einen sicheren Fluchtweg aufzeigt. Leuchten dieser Art werden in Betrieb genommen, wenn die anderen Leuchten nicht mehr funktionieren, und an strategischen Punkten in Gebäuden wie Einkaufszentren, Hotels, Krankenhäusern oder Büros platziert.

Daher zeugt die Verwendung hochwertiger Notbeleuchtung von Verantwortungsbewusstsein gegenüber den Menschen, für die sie vorgesehen ist. LED C4 achtet nicht nur strikt auf die technische und funktionelle Qualität dieser Leuchten, sondern auch darauf, dass sie so wenig wie möglich stören und sich perfekt in jeden Raum einfügen.

Cos'è l'illuminazione di emergenza?

L'illuminazione di emergenza, proprio come l'illuminazione tecnica e decorativa, ha un ruolo molto importante in quanto alla sicurezza e al benessere delle persone. È un elemento indispensabile ed obbligatorio, che ci permette di essere guidati verso una sicura evacuazione in caso di emergenza. Questo tipo di apparecchi di illuminazione, che entrano in funzione quando gli altri cessano di farlo, sono strategicamente installati in edifici come centri commerciali, hotel, ospedali o uffici.

Pertanto, la scelta di un'illuminazione di emergenza di qualità è un atto di responsabilità verso le persone che la utilizzano. In LED C4 ci impegnamo non solo per quanto riguarda le qualità tecniche e di funzionalità di questi apparecchi, ma lavoriamo anche perché questi irrompano il meno possibile e si integrino perfettamente in qualsiasi spazio.

Arten von Notleuchten Tipologia di apparecchi di emergenza

LEDS C4 bietet zwei Arten von Notleuchten an: Notleuchten und technische Notleuchten. Während es sich bei den ersteren um Standardlösungen handelt, kombinieren die letzteren technische Merkmale mit denen der Notbeleuchtung. Auf diese Weise wird es möglich, ein vielseitigeres Produkt anzubieten, das in jedes Projekt integriert werden kann, und dabei den Vorschriften entspricht, ohne die Ästhetik des Raumes zu beeinträchtigen.

LEDS C4 offre due tipologie di lampade di emergenza: lampade di emergenza e lampade di emergenza tecnica. Mentre le prime si riferiscono a soluzioni standard, le seconde uniscono le caratteristiche tecniche proprie di quelle dell'illuminazione di emergenza. Questa soluzione permette di offrire un prodotto più versatile che può essere integrato in qualsiasi progetto, rispettando le normative e senza irrompere nello spazio, in quanto all'estetica.

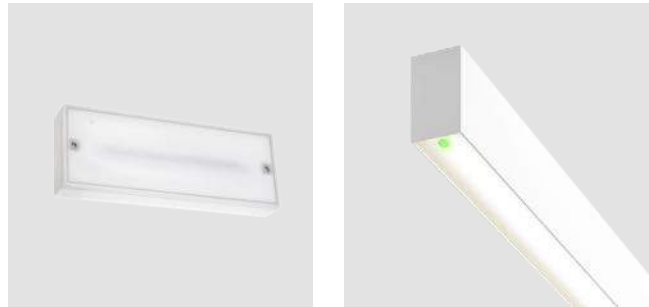

Maximale Integration. Harmonie zwischen Funktionalität und Design Massima integrazione. Equilibrio tra funzionalità e design

Mit der Einführung neuer Notfalloptionen bei den technischen Leuchten ist es möglich, das Design der Anlage zu vereinheitlichen und die Verwendung von Standard-Notleuchten zu vermeiden, die das Design oder das Konzept des Raumes beeinträchtigen könnten.

Con l'aggiunta di nuove opzioni di emergenza in apparecchi tecnici, è possibile omogeneizzare la progettazione dell'impianto evitando l'uso di apparecchi di emergenza standard che potrebbero alterare la progettazione o la concettualizzazione dello spazio.



Manusa, Polinyà (Barcelona)
Fotograf / Fotografo: Enric Badrinas

Wartung der Leuchten Manutenzione degli apparecchi di illuminazione

Die Notleuchten besitzen zwei Betriebsmodi: Dauerbetrieb und Bereitschaftsschaltung. Im Dauerbetrieb ist die Lichtquelle sowohl mit als auch ohne Stromversorgung stets eingeschaltet. In der Bereitschaftsschaltung verbleibt die Lichtquelle bis zum Zeitpunkt eines Stromausfalls im ausgeschalteten Bereitschaftszustand und wird erst dann eingeschaltet.

Gli apparecchi di emergenza sono disponibili in due modalità operative: Permanente e Non Permanente. In modalità permanente la sorgente luminosa è costantemente attiva, con o senza alimentazione elettrica. Per quanto riguarda la modalità non permanente, invece, la fonte di luce rimane in stato di allerta, in stato di spegnimento, fino a quando si verifica il guasto dell'alimentazione elettrica, ovvero quando si trova in stato di accensione.

Verschiedene Betriebsarten Diverse modalità di funzionamento

Da die Notbeleuchtung einen direkten Einfluss auf die Sicherheit der Menschen hat, ist es wichtig, dass der Zustand dieser Leuchten regelmäßig überprüft wird, um Risikosituationen zu vermeiden. Aus diesem Grund verfügen die Notleuchten über eine Status-LED, die ihren Betriebszustand anzeigt. Es gibt Leuchten mit Selbsttestfunktion, bei denen automatisch und regelmäßig überprüft wird, ob sowohl das Lichtmodul als auch die Akku bzw. Akkulaufzeit innerhalb der optimalen Parameter liegen.

Tenuto presente che l'illuminazione di emergenza influisce direttamente sulla sicurezza delle persone, è indispensabile, per evitare situazioni di rischio, che la verifica dello stato di tali apparecchi sia periodica. Per questo motivo, gli apparecchi di emergenza dispongono di un LED di stato operativo. Esistono apparecchi con funzione di autotest, in cui si verifica automaticamente e periodicamente che, sia il modulo luminoso che la batteria e l'autonomia, si trovino all'interno dei parametri ottimali.

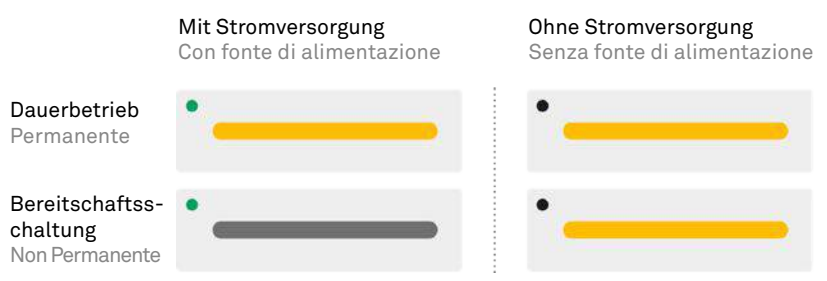

DALI-System in Notleuchten Sistema DALI in apparecchi di emergenza

Mittels DALI lässt sich der Leuchtenzustand fernüberwachen, sodass eine manuelle Überprüfung nicht erforderlich ist. Es können weitere Informationen über den Betrieb der Leuchten, z. B. die Betriebsstunden, abgerufen werden, um Wartungsarbeiten vorhersehen und planen zu können. Das System liefert Informationen über den Status und den Ladezustand der Batterie, Installationsdaten und den Notfallstatus.

Tramite un sistema di controllo DALI è possibile monitorare, a distanza, lo stato degli apparecchi evitando che il controllo sia manuale, oltre ad ottenere ulteriori informazioni sul loro funzionamento, come ad esempio le ore di funzionamento, consentendo di anticipare e prevedere il loro mantenimento. Grazie a questo sistema è possibile ottenere informazioni sullo stato della batteria e della sua carica, sui dati relativi all'installazione e sullo stato di emergenza.

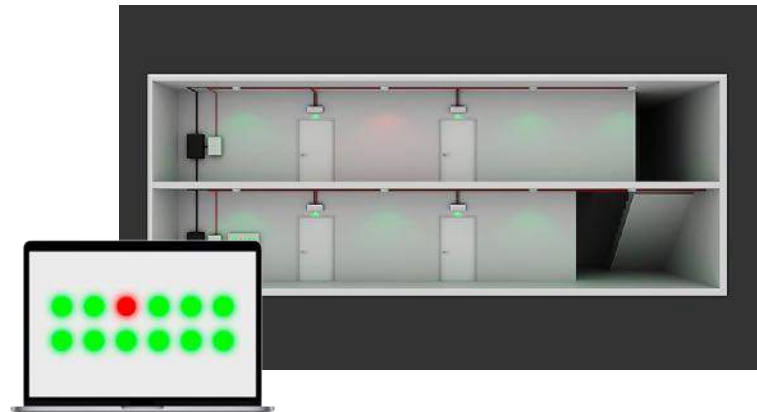

DALI-Systeme für Notleuchten Sistemi DALI per lampade di emergenza

Die mit den DALI-Notleuchten verbundene und verdrahtete DALI-Steuerung ermöglicht die laufende Abfrage des Betriebsstatus der Leuchten. Damit ist eine Fernüberwachung möglich und die aufwendige Vor-Ort-Überprüfung der LED-Leuchtmittel der Notbeleuchtung kann somit entfallen.

Un sistema di controllo DALI, collegato e cablato alle lampade di emergenza DALI, consente di ottenere informazioni sul loro stato, favorendo il controllo da remoto ed evitando quindi il controllo visivo di persona dei LED di segnalazione delle lampade di emergenza.

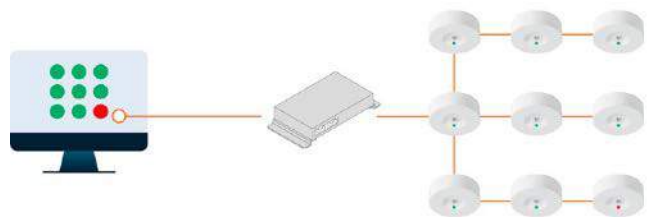

Drahtlose Notbeleuchtung Wireless di emergenza

Mit der Casambi-Technologie können die einzelnen Leuchten drahtlos in ein DALI-Managementsystem integriert und somit die Vorteile der Fernüberwachung und der kabellosen Installation gemeinsam genutzt werden.

La tecnologia Casambi consente di integrare in modalità wireless qualsiasi lampada in un sistema di gestione DALI, combinando i vantaggi del controllo da remoto e dell'installazione wireless.

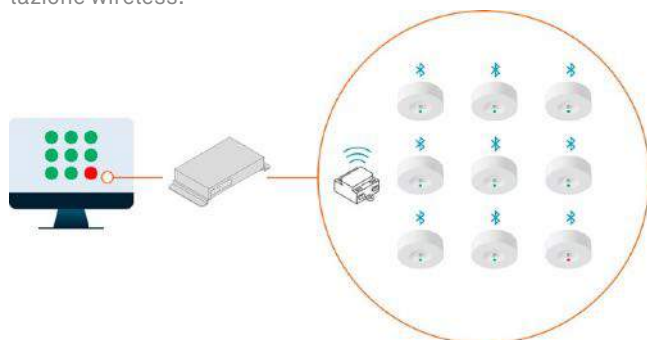





Redo

BODY MAT	DIF MAT		50000h	3
PC	PC		L80 B20	MacAdam



Visueller Komfort Comfort visivo

Kollektion von Notfall-Downlights mit einfachem Design und klaren Linien. Die Einbauversion ermöglicht die vollständige Integration in den Raum, sodass die Leuchte unbemerkt bleibt, da der Lichtpunkt versenkt ist. Konzipiert für Hotels, Hallen, Wohnhäuser und Büros.

Collezione di downlights di emergenza con un design semplice e con linee pure. Permette una completa integrazione nello spazio con la sua versione da incasso, che passa inosservata nell'ambiente grazie al suo punto di luce incassato. È pensata per spazi come alberghi, corridoi, residenze e uffici.

Dank des versenkten Lichtpunkts ist die Notfall-LED an der Decke nicht sichtbar, wodurch sich der Sehkomfort verbessert. Posizionando il punto di luce incassato, il LED di emergenza non è visibile sul soffitto e migliora, in questo modo, il comfort visivo.



Ausführungen Finiture

Erhältlich in weißer und schwarzer Ausführung, die sich für alle Innenkonzepte eignen.

Disponibile nelle finiture in bianco e nero, per adattarsi a tutti i concetti di interior design.

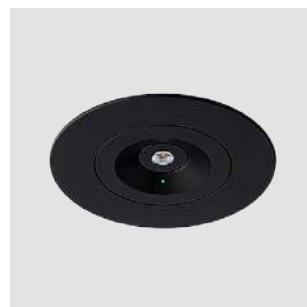

Überwachung mit DALI Monitoraggio DALI

Bei den DALI-Versionen lässt sich der Betriebszustand in Echtzeit überwachen.

Grazie alle versioni DALI è possibile eseguire il monitoraggio, in tempo reale, del suo stato operativo.

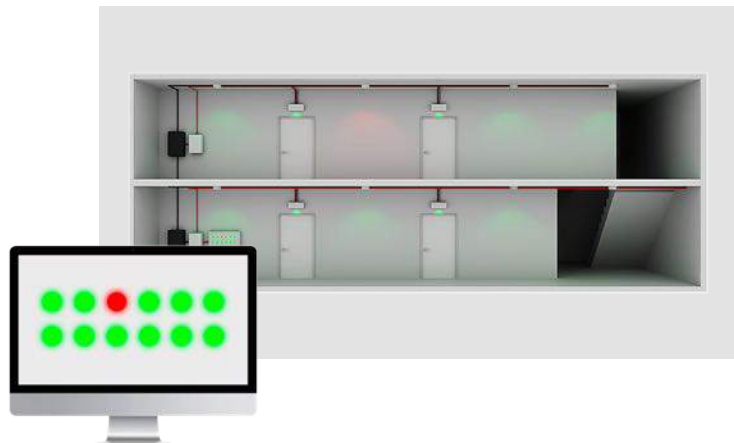

Vielseitige Installationsmöglichkeiten Versatilità nell'installazione

Einbauversion: geringe Größe, minimaler Platzverbrauch. Aufputzversion: kompakte Aufputzlösung mit nur 40,5 mm Höhe und 125 mm Durchmesser. Batterie, Treiber, Elektronik und LED sind im Inneren untergebracht.

Versione da incasso: dimensioni ed impatto minimi. Versione da superficie: soluzione da superficie compatta, di un'altezza di soli 40,5 mm e di un diametro di 125 mm. Al suo interno ospita la batteria, il driver, l'elettronica ed il LED.



Zubehöroptionen Opzioni di accessori

Adapter-Zubehör: Mit Adapter-Zubehör, falls die Decke bereits ein 85 mm-Loch aufweist. Es wird ein Zubehör vom Fahrentyp angeboten, mit dem ein Gleichgewicht zwischen der Funktionalität der Führung im Leerraum sowie der Integration in den Raum erreicht werden kann. Do we have a kind of pic to this. I don't have any clue what is ment.

Accessorio adattatore: dispone di un accessorio adattatore in caso di presenza di un foro precedente sul soffitto, di 85mm. Viene fornito un accessorio, tipo bandiera, che permette di ottenere l'equilibrio tra la funzionalità di guida nell'evacuazione e l'integrazione nello spazio.

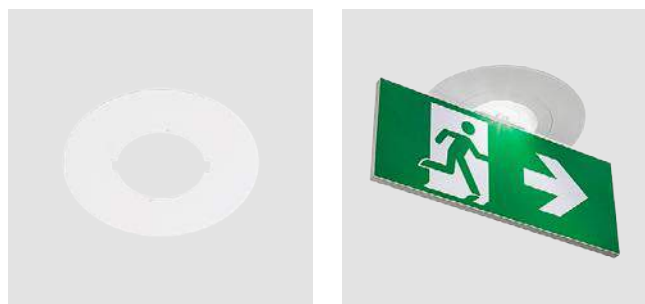

Vielfältige Anwendungsmöglichkeiten Versatilità nell'uso

Für denselben Artikel ist die Auswahl zwischen Standard- und Korridorlinse sowie Dauer- und Bereitschaftsbetrieb möglich. Standardlinse: bietet hohe Gleichmäßigkeit, ideal für quadratische Flächen und offene Bereiche.

Korridorlinse: ideal für lange Räume wie Flure. Großer Abstand zwischen den Leuchten.

Lo stesso codice permette la scelta di lente standard e lente corridor, oltre la funzione permanente e non permanente.

Obiettivo standard: offre un'elevata uniformità, ideale per spazi quadrati e spazi aperti.

Lente scorrevole: ideale per spazi lunghi come corridoi. Grande interdipendenza tra apparecchi.

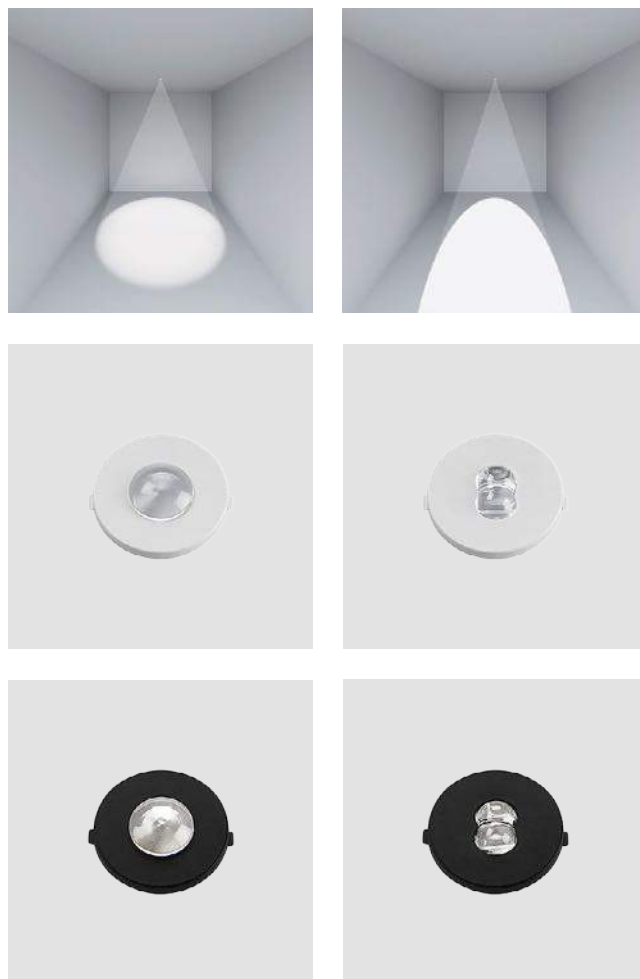

REDO

Redo Recessed

IK
10

UGR
<10



14 60

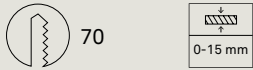
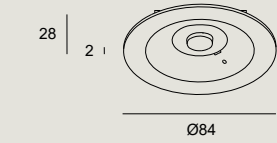

LED K:4000 CRI:80 BATTERY:NiCd						
W	Real Lm	Optics	H. emergency	Permanent	Auto test	Code
2.7	276	Medium 29°		Yes	Yes	EM04-0200PA1400
2.7	276	Medium 29°	1	Yes	DALI	EM04-0200PA1401
2.7	276	Medium 29°		Yes	Yes	EM04-0200PA6000
2.7	276	Medium 29°	1	Yes	DALI	EM04-0200PA6001
2.7	276	Medium 29°		Yes	No	EM04-0200PN1400
2.7	276	Medium 29°		Yes	No	EM04-0200PN6000
2.7	276	Medium 29°		Yes	Yes	EM04-0203PA6000
2.7	276	Medium 29°		Yes	No	EM04-0203PN6000
3.7	276	Medium 29°		Yes	Yes	EM04-0203PA1400
3.7	276	Medium 29°	3	Yes	DALI	EM04-0203PA1401
3.7	276	Medium 29°	3	Yes	DALI	EM04-0203PA6001
3.7	276	Medium 29°		Yes	No	EM04-0203PN1400
00	ON-OFF	220-240V	50-60Hz			
01	DALI	220-240V	50-60Hz			

nicht inklusive / Non incluso	
Durchmesseradapter Weiß Redo Adattatore di diametro Bianco Redo	EM04-0001
Durchmesseradapter Schwarz Redo Adattatore di diametro Nero Redo	EM04-0003

REDO



Redo Surface

IK	UGR
10	<10

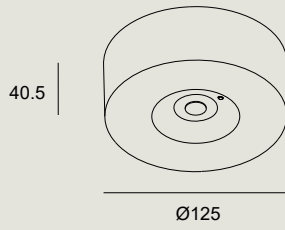
14  60 



LED K:4000 CRI:80 BATTERY:Lithium ion						
W	Real Lm	Optics	H. emergency	Permanent	Auto test	Code
2.7	276	Medium 29°		Yes	Yes	EM05-0203PA6000
2.7	276	Medium 29°		Yes	No	EM05-0203PN6000
4	276	Medium 29°		Yes	Yes	EM05-0203PA1400
4	276	Medium 29°	3	Yes	DALI	EM05-0203PA1401
4	276	Medium 29°	3	Yes	DALI	EM05-0203PA6001
4	276	Medium 29°		Yes	No	EM05-0203PN1400

Icon	Control	Voltage	Frequency
	ON-OFF	220-240V	50-60Hz
	DALI	220-240V	50-60Hz



89	Person icon	91	Person icon	96	Handshake icon
90	Person icon	92	Person icon	97	Handshake icon
91	Person icon	93	Person icon	98	Handshake icon
92	Person icon	94	Person icon	99	Person icon
93	Person icon	95	Person icon	100	Person icon

Deco

BODY MAT	DIF MAT		50000h	5
PC	PC		L80 B20	MacAdam



Integration in den Raum Integrazione nello spazio

Konventionelle Notleuchte für die Wand- oder Deckenmontage, Aufputz- oder Einbauversion (mittels Zubehör). Dank ihrer Form und Oberfläche bleibt sie unbemerkt.

Apparecchio di emergenza convenzionale di installazione a parete o a soffitto, in superficie o ad incasso (accessorio). La sua forma e la sua finitura lo rendono inosservabile nell'ambiente.

Gerade, saubere und reine Formen, mit einer matten, texturierten Oberfläche für eine unauffällige Integration in die Umgebung. Questo modello presenta forme dritte, pulite e pure, con una finitura texturizzata opaca per renderla inosservata nell'ambiente.



Überwachung mit DALI Monitoraggio DALI

Bei den DALI-Versionen lässt sich der Betriebszustand in Echtzeit überwachen.

Grazie alle versioni DALI è possibile eseguire il monitoraggio, in tempo reale, del suo stato operativo.

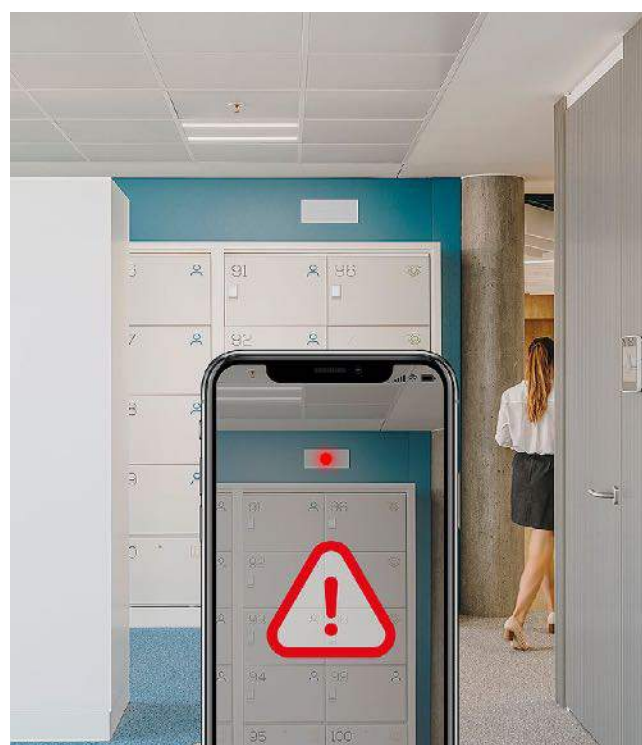

Vielseitiges Zubehör **Versatilità in accessori**

Mit verschiedenen Zubehörteilen kann die Einbauleuchte entweder an der Decke oder an der Wand installiert oder mit einem Piktogramm versehen werden.

Disponibile di vari accessori che permettono di installare l'apparecchio da incasso, sia a soffitto o a parete, fino ad aggiungere una segnalazione di evacuazione.



Zubehör für Wandeinbau
Accessorio da incasso a parete



Zubehör für Deckeneinbau
Accessorio da incasso a soffitto

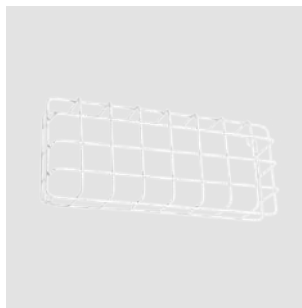

Anti-Vandalismus-Zubehör
Accessorio antivandalo



Zubehör für Signalisierung
Accessorio di segnalazione

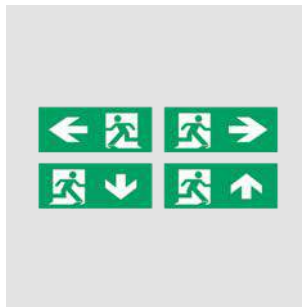

Zubehör für Piktogramme
Accessorio pittogrammi

DECO

Deco IP44

IK
10

14 

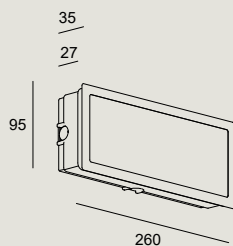

LED K:4000 CRI:80 BATTERY:NiCd					
W	Real Lm	H. emergency	Permanent	Auto test	Code
2	62	1	No	No	EM01-0060NN1400
2	93	1	No	Yes	EM01-0100NA1400
2	93	1	No	No	EM01-0100NN1400
2	93	3	No	No	EM01-0103NN1400
2	131	1	No	No	EM01-0150NN1400
2	160	1	No	Yes	EM01-0200NA1400
2	160	1	No	No	EM01-0200NN1400
2	206	3	No	No	EM01-0203NN1400
2	200	1	No	Yes	EM01-0300NA1400
2	200	1	No	DALI	EM01-0300NA1401
2	200	1	No	No	EM01-0300NN1400
2	200	1	No	No	EM01-0500NN1400
3.4	103	1	Yes	No	EM01-0100PN1400
3.4	93	3	Yes	No	EM01-0103PN1400
3.7	103	1	Yes	Yes	EM01-0100PA1400
4	206	1	Yes	Yes	EM01-0200PA1400
4.3	206	1	Yes	No	EM01-0200PN1400
4.3	206	3	Yes	No	EM01-0203PN1400
5	310	1	Yes	No	EM01-0300PN1400
5.1	310	1	Yes	Yes	EM01-0300PA1400
5.1	310	1	Yes	DALI	EM01-0300PA1401
5.7	501	1	Yes	No	EM01-0500PN1400

	00	ON-OFF	220-240V	50-60Hz
	01	DALI	220-240V	50-60Hz

DECO

Deco IP44

IK
10

14 

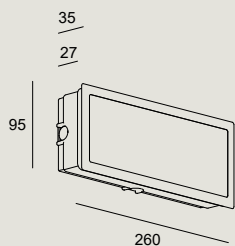

LED K:4000 CRI:80 BATTERY:NiMH					
W	Real Lm	H. emergency	Permanent	Auto test	Code
2	200	3	No	Yes	EM01-0303NA1400
2	200	3	No	DALI	EM01-0303NA1401
2	200	3	No	No	EM01-0303NN1400
5	310	3	Yes	No	EM01-0303PN1400
5.7	310	3	Yes	Yes	EM01-0303PA1400
5.7	310	3	Yes	DALI	EM01-0303PA1401

			
00	ON-OFF	220-240V	50-60Hz
01	DALI	220-240V	50-60Hz

nicht mitgeliefertes allgemeines Zub.

Access. comuni non inclusi

Einbaubehör DECO Accessorio da incasso DECO	EM01-0001
Wandeinbaubehör Deco Accessorio da incasso a parete Deco	EM01-0002
Zubehör Deco Anti-Vandalismus Accessori Deco anti vandalismo	EM01-0003
Piktogramm Pfeil nach rechts Pittogramma freccia a destra	EM01-0005
Piktogramm Pfeil nach links Pittogramma freccia a sinistra	EM01-0006
Piktogramm Pfeil nach oben Pittogramma freccia in alto	EM01-0007
Piktogramm Pfeil nach unten Pittogramma freccia in basso	EM01-0008

DECO

Deco IP65

IK
10

14 

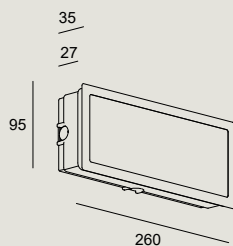

LED K:4000 CRI:80 BATTERY:NiCd					
W	Real Lm	H. emergency	Permanent	Auto test	Code
2	62	1	No	No	EM02-0060NN1400
2	93	1	No	Yes	EM02-0100NA1400
2	92	1	No	No	EM02-0100NN1400
2	93	3	No	No	EM02-0103NN1400
2	131	1	No	No	EM02-0150NN1400
2	160	1	No	Yes	EM02-0200NA1400
2	160	1	No	No	EM02-0200NN1400
2	160	3	No	No	EM02-0203NN1400
2	200	1	No	Yes	EM02-0300NA1400
2	200	1	No	DALI	EM02-0300NA1401
2	200	1	No	No	EM02-0300NN1400
2	200	1	No	No	EM02-0500NN1400
3.4	103	1	Yes	No	EM02-0100PN1400
3.4	103	3	Yes	No	EM02-0103PN1400
3.7	103	1	Yes	Yes	EM02-0100PA1400
4	206	1	Yes	Yes	EM02-0200PA1400
4.3	206	1	Yes	No	EM02-0200PN1400
4.3	206	3	Yes	No	EM02-0203PN1400
5	310	1	Yes	No	EM02-0300PN1400
5.1	310	1	Yes	Yes	EM02-0300PA1400
5.1	310	1	Yes	DALI	EM02-0300PA1401
5.7	501	1	Yes	No	EM02-0500PN1400

			
00	ON-OFF	220-240V	50-60Hz
01	DALI	220-240V	50-60Hz

DECO

Deco IP65

IK
10

14 

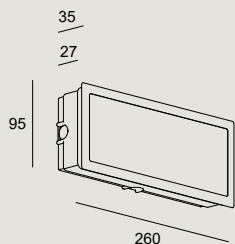

LED K:4000 CRI:80 BATTERY:NiMH					
W	Real Lm	H. emergency	Permanent	Auto test	Code
2	200	3	No	Yes	EM02-0303NA1400
2	200	3	No	DALI	EM02-0303NA1401
2	200	3	No	No	EM02-0303NN1400
5	310	3	Yes	No	EM02-0303PN1400
5.7	310	3	Yes	Yes	EM02-0303PA1400
5.7	310	3	Yes	DALI	EM02-0303PA1401

				
00	ON-OFF	220-240V	50-60Hz	
01	DALI	220-240V	50-60Hz	

nicht mitgeliefertes
allgemeines Zub.
Access. comuni non inclusi

Einbauszubehör DECO Accessorio da incasso DECO	EM01-0001
Wandeinbauszubehör Deco Accessorio da incasso a parete Deco	EM01-0002
Zubehör Deco Anti-Vandalismus Accessori Deco anti vandalismo	EM01-0003
Piktogramm Pfeil nach rechts Pittogramma freccia a destra	EM01-0005
Piktogramm Pfeil nach links Pittogramma freccia a sinistra	EM01-0006
Piktogramm Pfeil nach oben Pittogramma freccia in alto	EM01-0007
Piktogramm Pfeil nach unten Pittogramma freccia in basso	EM01-0008
Zubehör Signalisierung Deco Accessori Segnaletica Deco	EM02-0004



Flag

BODY MAT	DIF MAT		50000h	5
PC	PMMA		L80 B20	MacAdam



UGR		
<10	90°	ON-OFF

14

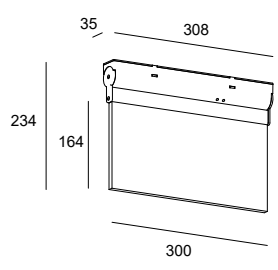

LED K:4000 CRI:80 BATTERY:NiCd DISTANCE:30 m						
W	Real Lm	H. emergency	Permanent	Auto test	Code	
3	70	3	Yes/No	Yes	EM03-0103PA1400	
220-240V		50-60Hz				

Star

BODY MAT	DIF MAT		50000h	5
PC	PMMA		L80 B20	MacAdam



UGR	
<16	ON-OFF

14

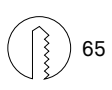
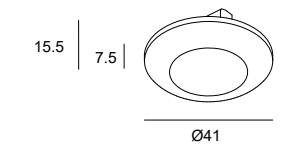

LED K:4000 CRI:80 BATTERY:NiCd						
W	Real Lm	H. emergency	Permanent	Auto test	Code	
0.2	6	3	No	No	EM06-0006NN1400	
230V		50-60Hz				

Deco Track

BODY MAT	DIF MAT		50000h	5
PC	PC		L80 B20	MacAdam

Für die Installation an einer Dreiphasenschiene ist eine Version des Modells DECO TRACK erhältlich, die die Integration der Notbeleuchtung in Ojekten mit Dreiphasenschienen ermöglicht.

Versione del modello DECO TRACK disponibile per l'installazione su binario trifase, permettendo di integrare l'illuminazione di emergenza in architetture dove, per la tipologia dell'installazione, vengono usati i binari per l'illuminazione.



Überwachung mit DALI Monitoraggio DALI

Bei den DALI-Versionen lässt sich der Betriebszustand in Echtzeit überwachen.

Grazie alle versioni DALI è possibile eseguire il monitoraggio, in tempo reale, del suo stato operativo.

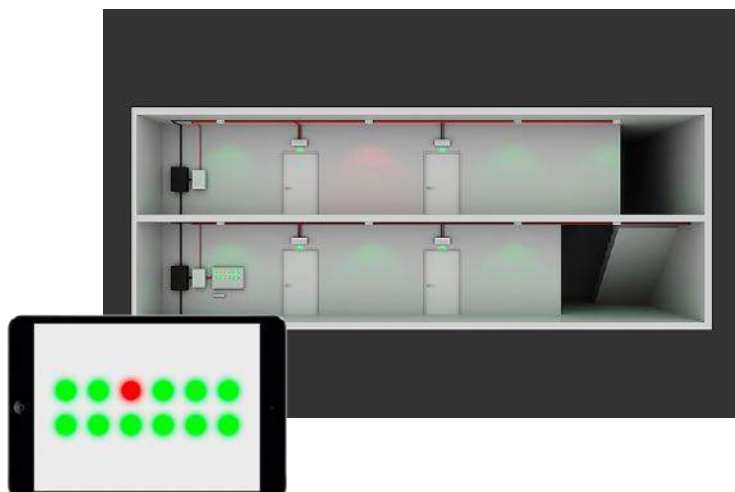

DECO TRACK

IK
10

14 

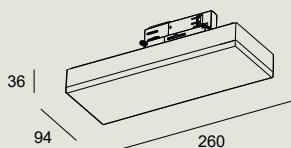

LED K:4000 CRI:80 BATTERY:NiCd					
W	Real Lm	H. emergency	Permanent	Auto test	Code
2	93	3	No	No	EM10-0103NN1400
2	93	3	No	DALI	EM10-0103NN1401
2	160	3	No	No	EM10-0203NN1400
2	160	3	No	DALI	EM10-0203NN1401
3.4	103	3	Yes	No	EM10-0103PN1400
3.4	103	3	Yes	DALI	EM10-0103PN1401
4.3	206	3	Yes	No	EM10-0203PN1400
4.3	206	3	Yes	DALI	EM10-0203PN1401

			
00	ON-OFF	220-240V	50-60Hz
01	DALI	220-240V	50-60Hz

IK
10

14 

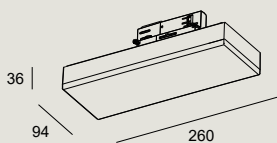

LED K:4000 CRI:80 BATTERY:NiMH					
W	Real Lm	H. emergency	Permanent	Auto test	Code
2	200	3	No	Yes	EM10-0303NA1400
2	200	3	No	No	EM10-0303NN1400
2	200	3	No	DALI	EM10-0303NN1401
5.7	310	3	Yes	Yes	EM10-0303PA1400
5.7	310	3	Yes	No	EM10-0303PN1400
5.7	310	3	Yes	DALI	EM10-0303PN1401

			
00	ON-OFF	220-240V	50-60Hz
01	DALI	220-240V	50-60Hz

nicht mitgeliefertes
allgemeines Zub.
Access. comuni non inclusi

Piktogramm Pfeil nach rechts Pittogramma freccia a destra	EM01-0005
Piktogramm Pfeil nach links Pittogramma freccia a sinistra	EM01-0006
Piktogramm Pfeil nach oben Pittogramma freccia in alto	EM01-0007
Piktogramm Pfeil nach unten Pittogramma freccia in basso	EM01-0008

Line

BODY MAT	DIF MAT		50000h	4
PC	AL		L80 B20	MacAdam

Vollständig in die Dreiphasenschiene integrierbare Notleuchte. Ermöglicht die Integration der Notbeleuchtung in Objekten, in denen es aufgrund ihrer Beschaffenheit Lichtschienen gibt. Apparecchio di emergenza completamente integrabile nel binario trifase. Permette di integrare l'illuminazione di emergenza in architetture in cui, per la tipologia dell'installazione, si usano binari per l'illuminazione.



Ausführungen Finiture

Erhältlich in weißer und schwarzer Ausführung, die sich an alle Innenkonzepte anpassen. Disponibile nelle finiture in bianco e nero, per adattarsi a tutti i concetti di interior design.



Überwachung mit DALI Monitoraggio DALI

Bei den DALI-Versionen lässt sich der Betriebszustand in Echtzeit überwachen. Grazie alle versioni DALI è possibile eseguire il monitoraggio, in tempo reale, del suo stato operativo.



LINE

IK
10

14  60 

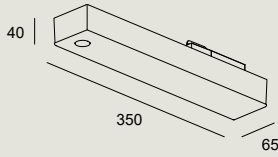

LED K:5500 CRI:70 BATTERY:NiMH						
W	Real Lm	H. emergency	Permanent	Auto test	Code	
1	89	3	No	No	EM08-0203NA1400	
1	89	3	No	DALI	EM08-0203NA1401	
1	89	3	No	No	EM08-0203NA6000	
1	89	3	No	DALI	EM08-0203NA6001	

	00	ON-OFF	220-240V	50-60Hz
	01	DALI	220-240V	50-60Hz

Leco

BODY MAT	DIF MAT		50000h	3
PC	PC		L80 B20	MacAdam

Leco ist eine Aufputz-Notleuchte, die sich ideal für die Beleuchtung von Durchgängen wie Fluren oder öffentlichen Bereichen eignet. Das Gehäuse wurde einer speziellen UV-Behandlung unterzogen, die das Vergilben der Materialien verhindert und für längere Zeit einen einwandfreien Zustand gewährleistet. Diese Leuchte kann im Normalbetrieb und bei Stromausfall auch im Notbetrieb eingesetzt werden.

Leco è un apparecchio di illuminazione di emergenza da superficie, ideale per l'illuminazione di zone di passaggio come corridoi od aree comuni. Il suo corpo incorpora uno speciale trattamento UV che evita l'ingiallimento dei materiali e garantisce un perfetto stato duraturo nel tempo. Questo apparecchio può essere utilizzato, funzionando in modo standard e in caso di emergenza, in caso di guasto elettrico.



LED-Statusleuchte an der Seite der Leuchte

LED indicatore posto sul lato dell'apparecchio

Mit grüner LED-Statusleuchte an der Seite der Leuchte.
Include un LED indicatore verde sul lato dell'apparecchio.



Überwachung mit DALI

Monitoraggio DALI

Bei den DALI-Versionen lässt sich der Betriebszustand in Echtzeit überwachen.

Grazie alle versioni DALI è possibile eseguire il monitoraggio, in tempo reale, del suo stato operativo.



LECO

IK	LOW	
10	FLICKER	ON-OFF

14

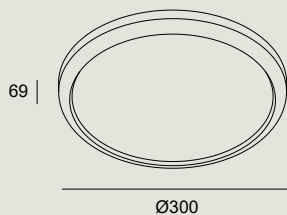

LED K:4000 CRI:80 BATTERY:NiCd						
W	Real Lm	H. emergency	Perma- nent	Auto test	Code	
8.7	911	3	Yes	No	15-A003 - 14 - OE	
220-240V		50-60Hz				

IK	LOW	
10	FLICKER	DALI

14

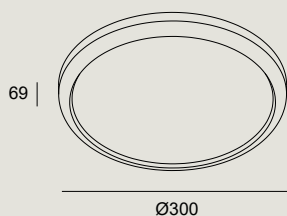

LED K:4000 CRI:80 BATTERY:LiFePO4						
W	Real Lm	H. emergency	Perma- nent	Auto test	Code	
8.7	911	3	Yes	Yes	15-A003 - 14 - DE	
220-240V		50-60Hz				

IK	LOW	
10	FLICKER	ON-OFF

14

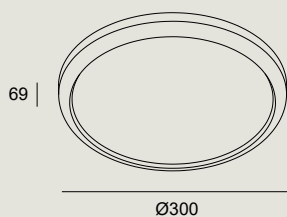

LED K:4000 CRI:80		
W	Real Lm	Code
8.7	911	15-A003 - 14 - OU
220-240V		50-60Hz

Play

BODY MAT	DIF MAT		50000h	2
AL	PMMA		L80 B20	MacAdam

Downlight-Kollektion mit hoher Modularität und Leistung. Sowohl in der Standard- als auch Notfallversion kann ein LED-Modul hinzugefügt und mit einer großen Vielfalt von Rahmen und Zubehörelementen für ein maßgeschneidertes Downlight, das die Anforderungen jedes Projekts erfüllt, kombiniert werden.

Collezione di downlights con una grande modularità e con grandi prestazioni. Entrambe le versioni, quella standard e quella di emergenza, permettono di aggiungere e combinare un modulo LED con una grande varietà di cornici ed accessori, ottenendo un downlight su misura, adatto alle esigenze di ogni progetto.



Exklusives Notfallmodul Modulo di emergenza esclusivo

Von LEDS C4 patentiertes System zur Anzeige des Leuchtenzustands, bei dem die Notfallanzeige in der Optik eingebaut ist, wodurch das Projekt einheitlicher gestaltet werden kann. Sistema di segnalazione dello stato dell'apparecchio brevettato da LEDS C4 con l'indicatore di emergenza incluso nella stessa ottica, consentendo una maggiore omogeneizzazione del progetto.



Überwachung mit DALI Monitoraggio DALI

Mit dem als Zubehör erhältlichen DALI-Selbsttest-Satz lässt sich die Funktionsfähigkeit der Leuchten in Echtzeit überwachen.

L'accessorio Kit autotest DALI permette di monitorare, in tempo reale, lo stato di funzionamento degli apparecchi.



Die Referenzen für die Kollektion Play Emergency sind ab Seite 191 zu finden.

Trova i codici della collezione Play Emergenza a partire dalla pagina 191.

Infinite Pro

BODY MAT	DIF MAT		50000h	3
AL	PC		L80 B20	MacAdam

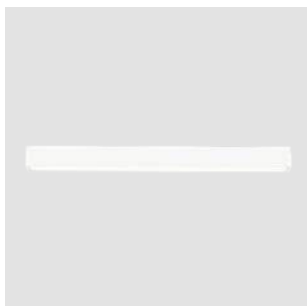

Infinite Pro stellt einen beispiellosen Durchbruch in der linearen Beleuchtung dar und besteht aus der Verbindung zweier Elemente: Gehäuse und Inneneinheit. Die außergewöhnlich-modular aufgebaute Kollektion bietet die Wahl zwischen einer der vier möglichen Installationsarten. Fünf Ausführungen und eine von acht möglichen Inneneinheiten, die wiederum über unterschiedliche Leistungen, Diffusoren, Längen und Versionen mit integrierter Konnektivität und Notbeleuchtungsvarianten verfügen vervollständigen das Programm. Bei der Notfallversion ist die Signal-LED in die Leuchte integriert. Dank der hohen Modularität dieser Kollektion ist es möglich, lineare Beleuchtung in jedem Raum anzubieten, ohne dass andere Leuchten, die das Beleuchtungskonzept beeinträchtigen, integriert werden müssen.

Infinite Pro, che rappresenta un progresso senza precedenti nell'illuminazione lineare, è costituita dalla combinazione di due elementi: la struttura ed il nucleo. La collezione, con una modularità eccezionale, permette di scegliere tra una delle 4 possibili installazioni, in 5 finiture e con uno degli 8 possibili nuclei che, a loro volta, hanno diverse potenze, diffusori, lunghezze e versioni di connettività integrata e di emergenza. Nella versione di emergenza è incluso il LED di segnalazione, integrato nell'apparecchio. La grande modularità di questa collezione permette di offrire un'illuminazione lineare in qualsiasi spazio senza dover incorporare altri apparecchi che modifichino il concetto illuminotecnico.

Eingebaute Signal-LED LED di segnalazione integrato

Bei Infinite ist die Signal-LED in die Leuchte integriert, wodurch die Installation viel einfacher ist und keine zusätzlichen Bauteile benötigt werden.

Infinite include il LED di segnalazione nell'apparecchio in modo che l'installazione sia molto più facile e non richieda elementi aggiuntivi.

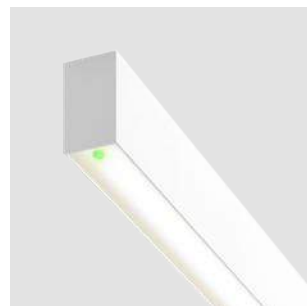

Überwachung mit DALI Monitoraggio DALI

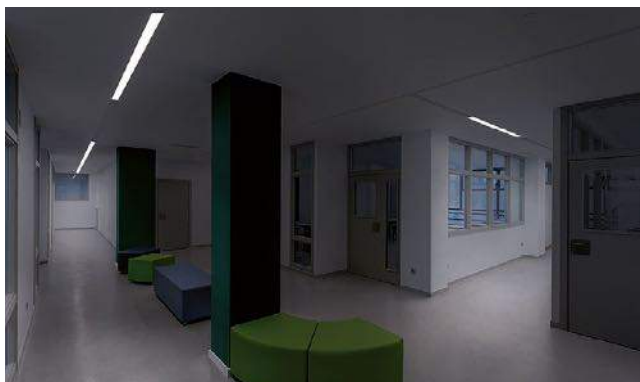

Bei den DALI-Versionen lässt sich der Betriebszustand in Echtzeit überwachen.

Grazie alle versioni DALI è possibile eseguire il monitoraggio, in tempo reale, del suo stato operativo.



Die Referenzen für die Kollektion Infinite Pro Emergency sind ab Seite 345 zu finden.

Trova i codici della collezione Infinite Pro Emergenza a partire dalla pagina 345.

Sia

BODY MAT	DIF MAT		50000h	2
AL	PC		L80 B20	MacAdam

Sia erzeugt ein an Geometrien, Volumen und Distanzen angepasstes Licht ohne Hindernisse. Durch die für Gleichmäßigkeit sorgende Polycarbonatlinse in Verbindung mit dem Hochvakuum-Chromreflektor, der einen einheitlichen Lichtpunkt erzeugt, bietet diese Leuchte ein gleichmäßiges Licht sowie maximalen visuellen Komfort mit hoher Leistung. Sie ist in Notfallversionen erhältlich, die einheitliche Anlagen ermöglichen, da keine verschiedenen Leuchten zur Integration der Anti-Panik-Beleuchtung verwendet werden müssen.

Sia proietta una luce che si adatta alle geometrie, ai volumi ed alle distanze, ossia una luce che non presenta alcun ostacolo. Grazie alla combinazione di una lente in policarbonato che apporta uniformità ed un riflettore cromato ad alto vuoto che fornisce un punto di luce uniforme, questo apparecchio offre il massimo comfort visivo, con elevate prestazioni. Disponibile nelle versioni di emergenza che permettono di ottenere installazioni omogenee dato che non è necessario utilizzare differenti apparecchi di illuminazione per incorporare l'illuminazione antipanico.

Externe Signal-LED LED di segnalazione esterno

Die Status-LED befindet sich außerhalb der Leuchte.
Il LED di segnalazione di stato è esterno all'apparecchio.



Überwachung mit DALI Monitoraggio DALI

Mit dem als Zubehör erhältlichen DALI-Selbsttest-Satz lässt sich die Funktionsfähigkeit der Leuchten in Echtzeit überwachen.

L'accessorio Kit autotest DALI permette di monitorare, in tempo reale, lo stato di funzionamento degli apparecchi.

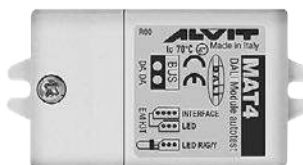

Die Referenzen für die Kollektion Sia Emergency sind ab Seite 159 zu finden.

Trova i codici della collezione Sia Emergenza a partire dalla pagina 159.

Bento

BODY MAT		50000h	3
PC,AL		L80 B20	MacAdam

Externe Signal-LED LED di segnalazione esterno

Die Kollektion aus linearen Downlights ist das Ergebnis langjähriger Arbeit der Produktentwickler von LEDS C4 mit dem Ziel, eine Leuchte zu entwickeln, die hohen visuellen Komfort und einen optimalen Wirkungsgrad bietet. Die Notfallversion sorgt für eine einheitlichere Gestaltung des Projekts und bietet Anti-Panikbeleuchtung im selben Leuchtenmodell.

Collezione di downlights lineari, frutto di un lungo studio da parte degli sviluppatori di prodotto di LEDS C4, con il fine di ottenere un apparecchio di illuminazione ad alto comfort visivo e con prestazioni ottimali. La sua versione di emergenza permette che il progetto sia più omogeneo e che con lo stesso modello di apparecchio si possa generare anche un'illuminazione antipanico.

Die Status-LED befindet sich außerhalb der Leuchte.
Il LED di segnalazione di stato è esterno all'apparecchio.



Überwachung mit DALI Monitoraggio DALI

Die Referenzen für die Kollektion Bento Emergency sind ab Seite 245 zu finden.
Trova i codici della collezione Bento Emergenza a partire dalla pagina 245.

Mit dem als Zubehör erhältlichen DALI-Selbsttest-Satz lässt sich die Funktionsfähigkeit der Leuchten in Echtzeit überwachen.

L'accessorio Kit autotest DALI permette di monitorare, in tempo reale, lo stato di funzionamento degli apparecchi.

Vevo

BODY MAT	DIF MAT		50000h	3
PC,AL	PC		L80 B20	MacAdam

Die Referenzen für die Kollektion Vevo Emergency sind ab Seite 181 zu finden.
Trova i codici della collezione Vevo Emergenza a partire dalla pagina 181.

Eine Downlight-Kollektion mit verschiedenen Einbaudurchmessern, die für Räume mit unterschiedlichen Verwendungszwecken angepasst werden können und so den Einbau in Decken erleichtern, in denen sich bereits ein Deckenausschnitt befindet.

Collezione di faretti per spazi destinati a vari usi e scopi, che si adatta a diversi diametri di incasso, facilitando così la loro installazione in soffitti dove è esistente un foro precedente.



Afrodita

BODY MAT	DIF MAT		50000h	3
AL	GLA		L80 B20	MacAdam

Die Referenzen für die Kollektion Afrodita Emergency sind ab Seite 773 zu finden.

Trova i codici della collezione Afrodita Emergency a partire dalla pagina 773.

Wandleuchte mit modernen und einfachen Linien zur Beleuchtung von Außenbereichen. Eine Verwendung zum Hervorheben von Wegen oder Eingängen von der Wand aus ist möglich.

Una applique con linee semplici e moderne progettate per illuminare spazi esterni. Può essere utilizzato per enfatizzare percorsi o ingressi, dalla parete.



Solid

BODY MAT	DIF MAT		50000h	5
PC	PC		L80 B20	MacAdam

Die Referenzen für die Kollektion Solid Emergency sind ab Seite 852 zu finden.

Trova i codici della collezione Solid Emergency a partire dalla pagina 852.

Lineare Feuchtraumwannenleuchte mit starker Leuchtkraft. Hoher Schutzgrad gegen Stöße und das Eindringen von Wasser oder Staub. Auch zur Verwendung in besonders schutzbedürftigen Bereichen wie Parkplätzen oder öffentlichen Bereichen in Wohngebieten im Freien.

Plafoniera lineare con un elevato risultato illuminotecnico. È dotato di un alto grado di protezione contro gli urti e l'ingresso di acqua o polvere. Può essere utilizzato in spazi che richiedono una protezione speciale, come parcheggi od aree comuni di zone residenziali esposte a condizioni avverse.



Notfall-Kits

Kit di conversione

Die Umrüstkits ermöglichen den zeitlich begrenzten Einsatz einer Leuchte als Zusatzbeleuchtung zur Notbeleuchtung. I kit di conversione consentono ad un apparecchio di funzionare per un tempo predeterminato, fungendo da illuminazione ausiliaria a quella di emergenza.



Autotest		Code
Si	DALI	EM06-0001

Auto Test-Kit + DALI kompatibel für 1 h und 3 h.
Kit autotest + DALI compatibile per 1 h e 3 h

Mit zweifarbiger LED.
Include un LED bicolore.



IP	Class	V _{in}	Frecuencia	V _{out} emergency mode	I _{out} emergency mode	h	Battery	Code
20	2	220-240V	50-60Hz	10-48V	350-100mA	1h	Ni-Cd	EM06-0002
20	2	220-240V	50-60Hz	10-48V	200-60mA	3h	Ni-Cd	EM06-0003

Mit grüner LED-Anzeige.
Include un indicatore LED verde.

Kompatibel mit / Compatibile con

Beleuchtungsmodule mit einer Eingangsspannung zwischen 10 und 48 V.

Moduli illuminotecnici con una tensione di ingresso compresa tra 10 e 48 V.

Lichtintensität im Notfall-Batteriebetrieb 1 h
Flusso luminoso in modalità di emergenza batteria 1 h

Power	10W	15W	20W	25W	30W	40W	50W
Prozentsatz Percentage	60%	40%	30%	25%	20%	15%	10%

Lichtintensität im Notfall-Batteriebetrieb 3 h
Flusso luminoso in modalità di emergenza batteria 3 h

Power	10W	15W	20W	25W	30W	40W	50W
Prozentsatz Percentage	35%	24%	18%	14%	12%	9%	7%

*Werte für 36 V. Wenden Sie sich für andere V_{in}-Eingangsspannungskonfigurationen bitte an unser Kundendienstteam.
* Valori indicati a 36V, consultare il nostro team commerciale per altre impostazioni di tensione con ingresso V_{in}.

Konnektive
Lösungen
Soluzioni
connette

Casambi



Beleuchtungssteuerung basierend auf einem Bluetooth Mesh-Protokoll mit direkter Steuerung über Smartphone oder Tablet, ohne dass zusätzliche Komponenten erforderlich wären. Aufgrund der einfachen Bedienung ist dieses System für jeden Anwender geeignet. Seine Anwendung ist ideal für flexible und dynamische Umgebungen, in denen eine umfassende Interaktion mit den Leuchten erforderlich ist.

Soluzione di controllo dell'illuminazione basata sul protocollo bluetooth Mesh con controllo diretto da smartphone o tablet, senza la necessità di aggiungere ulteriori elementi. La facilità d'uso del sistema lo rende valido per qualsiasi utente. La sua applicazione è ideale per ambienti flessibili e dinamici, dove è necessaria una grande interazione con gli apparecchi.

LEDS C4 bietet smarte Beleuchtungssysteme mit integrierter Casambi Technologie. Ebenso smarte und kompatible Beleuchtungssysteme mit den folgenden Regeltechniken: DALI, 0/1 - 10V Phasenabschnitt, DMX oder PWM (Niederspannung, 12 - 24 V).

LEDS C4 offre apparecchi Smart per l'illuminazione dotati di tecnologia Casambi incorporata. Offre inoltre Apparecchi Smart Compatible con alcune di queste tecnologie di regolazione: DALI, 0/1-10V, Tagliodi fase trailing edge, DMX o PWM (bassa tensione 12-24V).



Funktionsumfang Funzioni



- Individuelle Steuerung der Leuchten und Punkt-zu-Punkt Regulierung
Controllo individuale degli apparecchi e regolazione punto per punto
- Erstellung von Lichtgruppen
Creazione di gruppi di apparecchi
- Lichtregulierung nach Jahreszeiten
Regolazione in base al calendario
- Regulierung der Farbtemperatur
Controllo della temperatura di colore
- Circadianer Zyklus
Ciclo circadiano
- Tageslichtabhängige Regulierung
Regolazione in base al livello di luce naturale

Technologie Tecnologia

Bluetooth Low energy Bluetooth Low energy

Lösung auf Bluetooth-Basis. Dabei handelt es sich um die gleiche Technologie, die bereits in mobile Smartphones oder Tablets integriert ist. Dies ermöglicht eine direkte Kommunikation zwischen Leuchte/Steuerung und mobilem Gerät, ohne dass zusätzliche physikalische Elemente zur Steuerung verwendet werden müssen.

Soluzione basata sulla tecnologia Bluetooth, la stessa tecnologia già integrata nei dispositivi mobili smartphone o tablet. Questo consente una comunicazione diretta tra apparecchio/controller e dispositivo mobile, senza la necessità di aggiungere ulteriori elementi fisici per il controllo.



Wireless Mesh Network Wireless Mesh Network

Skalierbares System, das die Erstellung eines Informationsnetzwerks (Knoten) nach Maß ermöglicht, wenn Geräte hinzugefügt werden. Die Intelligenz des Systems wird an jedem Knoten repliziert, so dass beim Verschwinden eines Knotens, der Rest des Systems weiterhin funktionsfähig ist. Bedingt durch dieses Mesh-System und die Bluetooth-Technologie ist für die lokale Steuerung keine Internetverbindung erforderlich. Sistema scalabile che permette di creare una rete di informazioni (nodi) aggiungendo dispositivi. L'intelligenza del sistema si replica in ogni nodo, in modo che se un nodo scompare, il resto del sistema continua a funzionare. Grazie a questo sistema in rete e alla tecnologia Bluetooth, non è necessario un collegamento a Internet per un controllo locale.

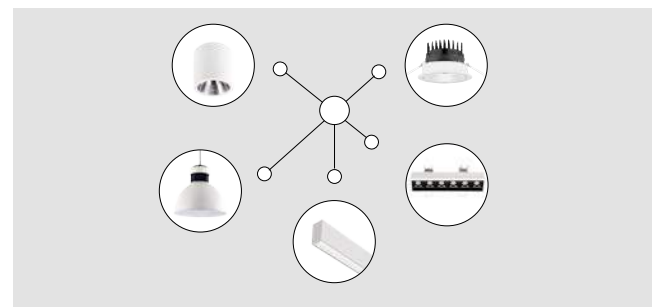







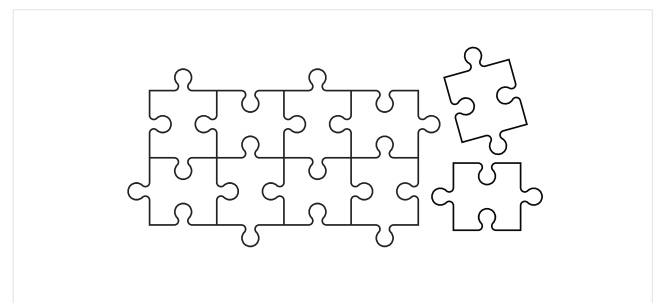





Ecosistema Casambi Ecosistema Casambi











Das Casambi-Ecosystem ermöglicht eine große Kompatibilität zwischen verschiedenen Produkten wie: Sensoren, Schalter,

L'ecosistema Casambi permette una grande interoperabilità tra diversi prodotti come sensori, interruttori, ecc.



Zubehör Casambi / Accessorio Casambi

		L x W x H mm	IP	V in F (Hz)	Leuchten Apparecchi DALI	W max	Protocol	Code
	Regler 0-10 V - DALI Regolatore 0-10V - DALI	56 x 36 x 22	IP20	220-240V 50-60Hz	1	-	0-10 / DALI	71-5961-00-00
	Phasendimmung-Regler Regolatore trailing edge	40 x 36 x 14	IP20	100-240V 50-60Hz	1	150W	Trailing edge	71-5959-00-00
	Regler vom Typ 4 ch PWM Regolatore 4 ch PWM	72,6 x 30 x 18	IP20	12-24V DC	1	72W 12VDC, 144W 24VDC	PWM 4 canales	71-8050-00-00
	PWM Regler 1 Kanal Regolatore PWM 1 canale	45 x 58 x 19	IP20	100-240V 50-60Hz	1	120W 12VDC, 240W 24VDC	PWM 1 canal	71-A857-00-00
	Fuente alimentación PWM de 1 canal 24V Fonte de alimentação PWM de 1 canal 24V	191 x 63 x 37,5	IP67		1	120W 24V	PWM 1 canal	71-A242-00-00
	IP65 Gehäuse, PWM Netzgerät und Lichtregulierung 4 Kanäle Scatola IP65 Alimentazione e regolatore PWM 4 canali	253 x 342 x 132	IP65	100-277V 50-60Hz		144W, 24VDC	PWM 4 canales	71-E300-00-00
	DALI Lichtregulierung Broadcast Regolatore DALI Broadcast	38 x 38 x 26	IP64	100-240 50-60Hz	50	100mA DALI	DALI Dt8 Broadcast	71-A301-00-00
	Casambi DALI 8 Gruppen-Konverter Converter Casambi DALI 8 gruppi	180 x 42 x 25	IP20	24-48V DC	64	250mA Bus DALI	DALI 8 grupos	71-A239-00-00
	DALI-Regler, kompatibel mit Track Low Voltage Dimmer DALI compatibile con Track Low Voltage	143 x 18 x 59	IP20	24-48VDC	64	250mA Bus DALI	DALI Broadcast	71-8115-00-00
	DALI Broadcast- Dimmer an weißer Schiene Dimmer DALI Broadcast su guida bianca	91 x 45 x 124	IP20	100-240 50-60Hz	64	250mA Bus DALI	DALI Broadcast	71-A243-14-14
	DALI Broadcast- Dimmer an schwarzer Schiene Dimmer DALI Broadcast su guida nera	91 x 45 x 124	IP20	100-240 50-60Hz	64	250mA Bus DALI	DALI Broadcast	71-A243-60-60
	Casambi-DALI- Konverter IP66 Conversor Casambi DALI IP66	108 x 62 x 108	IP66	100-240 50-60Hz	64	150mA Bus DALI	DALI Broadcast	71-A237-00-00
	Casambi-DMX- Konverter IP66 Conversor Casambi DMX IP66	108 x 62 x 10	IP66	100-240 50-60Hz	-	-	DMX Broadcast	71-A238-00-00

		L x W x H mm	IP	V in F (Hz)	Leuchten Apparecchi DALI	W max	Protocol	Code
	DALI-Casambi-Steuergerät Controller DALI Casambi	40 x 36 x 14	IP20	9,5-22,5VDC	-	DALI	-	71-8051-00-00
	Off-On Relais Relè On Off	50 x 120 x 32	IP40	100-240 50-60Hz	-	1500 W	On Off	71-A300-00-00
	Unterputz Sensor Umgebungs-helligkeit und Präsenz mit DALI Ausgang Sensore da incasso Luminosità e presenza con uscita DALI	Ø 76 x 69	IP40	230V 50Hz	10	1500W, 20mA bus DALI	DALI Broadcast	71-A696-00-00
	Anwesenheits- und Helligkeitssensor Sensore di presenza e luminosità	Ø 85 x 88	IP20	220-240V 50Hz	-	-	-	71-8049-00-00
	Anwesenheits- und Helligkeitssensor an schwarzer dreiphasiger Schiene Sensore di presenza e luminosità su guida nera trifase	70 x 59 x 39	IP20	220-240V 50Hz	-	-	-	71-A241-60-60
	Anwesenheits- und Helligkeitssensor an weißer dreiphasiger Schiene Sensore di presenza e luminosità su guida bianca trifase	70 x 59 x 39	IP20	220-240V 50Hz	-	-	-	71-A241-14-14
	Casambi-Tastenfeld schwarz Tastiera Casambi nera	90 x 90 x 12	IP20	Bateria CR2430	-	-	-	71-8053-00-00
	Casambi-Tastenfeld weiß Tastiera Casambi bianca	90 x 90 x 12	IP20	Bateria CR2430	-	-	-	71-A240-00-00
	Casambi-Timer für zeitliche Programmierung Timer Casambi per programmazioni orarie	45 x 58 x 25	IP20	45 x 12-48 x 25	-	-	-	71-8052-00-00
	Digital-Konverter 4 Kanäle Convertitore 4 Segnali digitali	Ø 53 x 21	IP20	230V 50Hz	-	max.10 mA	Spannungsfreie digitale Eingänge Ingressi digitali a potenziale zero	71-A302-00-00
	Glühbirne E27 TW 2200-6500K Casambi Lampadina E27 TW 2200-6500K Casambi	Ø 60 x 115	IP20	100-240V 50-60Hz	-	8W-	-	71-A697-00-00

Steuerungs- und Konnektivitätslösung für die Beleuchtung in Räumen, in denen ein effizienter Ressourceneinsatz erforderlich ist. Basiert auf dem D4i-Standard und sorgt dafür, dass jeder mit dieser Technologie ausgestattete Treiber mit dieser Plattform kompatibel ist. Neben der Steuerung ermöglicht dieses Produkt die Überwachung des Systems über die Plattform, um Daten zur Auslastung und Raumnutzung abrufen zu können. Soluzione di controllo e di connettività dell'illuminazione in uno spazio in cui è richiesto l'uso efficiente delle risorse. Basato sullo standard D4i, consente che qualsiasi driver dotato di tale tecnologia sia compatibile con questa piattaforma. Oltre ad offrire funzionalità di controllo, consente al sistema di essere monitorato attraverso la piattaforma e di ottenere dati relativi all'occupazione e allo spazio.

Funktionsumfang Funzioni



- Drahtlose Kommunikation von Leuchten mit Internetzugang. Fernsteuerung
Comunicazione wireless di apparecchi con accesso a Internet.
- Fernsteuerung
Telecomando
- Zustand der Installations
Stato dell'installazione
- Definition von Profilen und Gruppen
Definizione di profili e gruppi



- Ersparnis durch natürliches Licht, Auslastung und Aufgabenanpassung
Risparmio di luce naturale, di occupazione e di adeguamento del compito
- Energieberichte entsprechend den Anforderungen der jeweiligen Maßnahme
Rapporti energetici adeguati alle esigenze di ogni azione intrapresa
- Echtzeit-Überwachung der verbrauchten Leistung und der Ersparnis
Monitoraggio, in tempo reale, dell'energia consumata e risparmiata



- Informationen zur Umgebungs- und Leuchtentemperatur für eine bessere Integration mit den Klima- und Heizungsanlagen
Informazioni sulla temperatura ambiente e sull'apparecchio, per facilitare l'integrazione con i sistemi di climatizzazione e riscaldamento













- Alarmmanagement
Gestione degli allarmi
- Nach verschiedenen Parametern programmierbare E-Mail- Benachrichtigungen z. B. bei Ausfall von Leuchten oder Überhitzungen, Aktualisierungen, ...
Notifiche via e-mail programmabili in base a diversi parametri quali guasto di apparecchi di illuminazione o surriscaldamento, aggiornamenti disponibili, ...



- Heat-Map-Berichte für eine angemessene Bewirtschaftung und Bewertung der Räume
Rapporti delle mappe di calore per la corretta gestione degli spazi e della loro valutazione

Zubehör D4i / Accessorio D4i

		L x W x H mm	V in F (Hz)	Leuchten Apparecchi max.	Protocol	Code
	PoE-Netzteil Alimentazione PoE	235 x 103 x 27	48V	-	PoE	71-8064-00-00
	D4i Energie-Manager Controller-Manager Piattaforma D4i	198 x 145 x 42	120-240V 50-60Hz	1500 Sensors	-	71-8063-00-00
	Sensor-Gateway Sensore Gateway	35 x 101,9 x 76,5	PoE	125 Sensors	IEEE 802.15.4	71-8061-00-00
	Vernetzter Multisensor Multisensore Connettivo	27 x 18	D4i	4 Drivers	D4i	71-8056-00-00
	Multisensor PRO Multisensore PRO	27 x 18	D4i	4 Drivers	D4i	71-8057-00-00
	Connected-Track-Multisensor Multisensore Connected Track	120 x 40 x 35	220-240V 50-60Hz	4 Drivers	D4i	35-A075-60-00
	Connected-Track-Multisensor Multisensore Connected Track	120 x 40 x 35	220-240V 50-60Hz	4 Drivers	D4i	35-A075-14-00
	Vernetztes Tastenfeld Tastiera connettiva	66,4 x 32,7 x 11,5	Battery CR2032	-	IEEE 802.15.4	71-8062-00-00
	Update vernetzter Multisensor Pro Aggiornamento multisensore connettivo Pro	-	-	-	Software	71-8060-00-00
	Unterputz Deckenmontage für Sensor D4i Accessorio da incasso soffitto per Sensore D4i	20,7 x 13	-	-	-	71-8058-00-00
	Aufputz Deckenmontage für Sensor D4i Accessorio da superficie soffitto per Sensore D4i	25 x 35 x 67	-	-	-	71-8059-00-00

Light for life

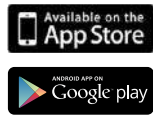

Lösung für die Beleuchtungssteuerung mittels drahtloser Bluetooth-/Wi-Fi-Technologie, je nach Produkttyp. Sie ermöglicht die direkte Steuerung mit dem Smartphone über die schnelle und benutzerfreundliche App Light for Life. Das System ist mit allen gängigen Sprachassistenten kompatibel. Soluzione di controllo dell'illuminazione basata sulla tecnologia wireless bluetooth/wifi, a seconda del tipo di prodotto. Consente il controllo diretto con lo smartphone, tramite l'app Light for Life, un'applicazione veloce e facile da usare. Il sistema è compatibile con i principali assistenti vocali.







Funktionsumfang Funzioni



- Individuelle Steuerung der Leuchten direkt von einem Smartphone aus
Controllo individuale degli apparecchi direttamente da uno smartphone
- Steuerung von Farbtemperatur und RGB der Leuchten
Controllo di temperatura di colore e RGB delle luminarie
- Erstellung von Szenen, um die ideale Atmosphäre für jeden Moment zu kreieren
Creazione di scene per regolare l'atmosfera ideale in ogni momento
- Einprogrammierung der Zeitpläne für automatische Aktivierungen
Impostazioni orarie per l'attivazione automatica

Zubehör Light for Life / Accessorio Light for Life

		L x W x H mm	IP	V in F (Hz)	Leuchten Apparecchi max.	W max.	Protocol	Code
	Regler 0/1-10V oder Dali Regolatore 0/1-10V o Dali	100 x 38 x 21	20	110-240V 50-60Hz	0-10V: max 10 DALI: max 20	0-10V: max 1000W (220V) max 500W (110V)	0/1-10V DALI	71-8218-00-00
	On/Off-Relais Relè On/Off	88 x 39 x 23	20	110-240V 50-60Hz	-	1100W for 110V	On-Off	71-A189-00-00

		LED	Tc	P (W)	Lm	V	Hz	Protocol	Optics	Code
	Leuchtmittel E27 RGBW Wifi Lampadina E27 RGBW Wifi	E27	RGBW	12	950*	220- 240V	50Hz	Light for Life	180°	71-8219-00-00
	Leuchtmittel GU10 TW Wifi Lampadina GU10 TW Wifi	GU10	TW	5	345*	220- 240V	50Hz	Light for Life	180°	71-8220-00-00
	Leuchtmittel E14 TW Wifi Lampadina E14 TW Wifi	E14	TW	5	470*	220- 240V	50Hz	Light for Life	200°	71-8221-00-00

DALI2

Beleuchtungssteuerung basierend auf dem Standard DALI2 (einschließlich Kompatibilität mit DT8-Treibern).

Soluzione di controllo dell'illuminazione, basata sullo standard DALI2 (include il supporto per i driver DT8).



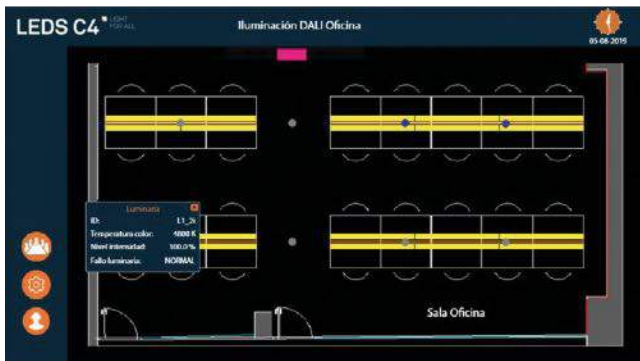

Funktionsumfang Funzioni

Möglichkeit hoher Energieeinsparungen durch Funktionen wie die Verwaltung einzelner Leuchten, Leuchtengruppen, Szenen, konstantes Licht, Biorhythmus, die Steuerung durch Anwesenheit und die Programmierung der Uhrzeit. Möglichkeit der Berechnung der Betriebsstunden und des Verbrauchs jeder Leuchte für die präventive Wartung. Die Fehlermeldungen können an eine E-Mail gesendet werden. Die individuelle, bedarfsorientierte Programmierung eröffnet unbegrenzte Möglichkeiten. Die Programmierung erfolgt mit einer Programmiersoftware vor Ort oder über einen Webserver. Im Rahmen dieser Programmierung können im Plan auch die Installation und die Leuchten reell und aktualisiert angezeigt werden.

Consente di ottenere in un'installazione, un grande risparmio energetico attraverso funzionalità come la gestione degli apparecchi da punto a punto, gruppi, scene, controllo costante della luce, ciclo circadiano, controllo dell'occupazione ed orari, tra altri. Il sistema permette di calcolare le ore di funzionamento e il consumo di ciascun apparecchio, oltre a poter effettuare una manutenzione preventiva reattiva. Gli allarmi di errore possono essere inviati a un indirizzo e-mail. Essendo un programma personalizzato per ogni esigenza, le possibilità sono illimitate. La programmazione viene eseguita tramite software di programmazione on-site o tramite il web server. All'interno di questa programmazione è anche possibile visualizzare l'installazione e le lampade, in forma reale ed aggiornata.



Zubehör DALI2 / Accessorio DALI2









		L x W x H mm	IP	V in F (Hz)	Leuchten Apparecchi max.	W max	Protocol	Code
	Master-Steuerung DALI2 Controller Master DALI2	159 x 100 x 75	40	85-240V 50-60Hz	64	DALI BUS OUTPUT 230mA max	DALI2	71-8065-00-00
	Multisensor für DALI2- System Multisensore per sistema DALI2	80 x 50	20	16V	-	-	DALI2	71-8066-00-00
	DALI2-Anschluss Accoppiatore DALI2	78 x 78	20	16V	-	-	DALI2	71-8068-00-00
	Tastenfeld DALI2 4 Funktionen Pannello frontale DALI2 4 funzioni	86 x 86 x 8,5	20	-	-	-	-	71-8070-00-00
	Tastenfeld DALI2 9 Funktionen Pannello frontale DALI2 9 funzioni	86 x 86 x 8,5	20	-	-	-	-	71-8071-00-00





Standalone-Lösung Soluzioni Standalone



Lösungen zur Einzelanwendung. Diese Lösungen ermöglichen die autonome Steuerung einer oder mehrerer Leuchten im gleichen Raum. Mit Standalone-Lösungen lassen sich einfache Funktionen ausführen und große Energieeinsparungen erzielen.

Soluzioni di controllo autonome. Possono essere utilizzate per controllare uno o più apparecchi presenti nello stesso spazio, in modo autonomo. Con le soluzioni Standalone possiamo impiegare semplici funzioni ed ottenere importanti risparmi energetici.





Zubehör Standalone / Accessorio autonome

		L x W x H mm	V in F (Hz)	mA	Leuchten Apparecchi max.	W max	Protocol	Code
	DALI Standalone multi-sensor Multisensore DALI autonomo	80 x 50	95-250 50-60Hz	-	16	DALI BUS OUTPUT 35mA max	DALI	71-8067-00-00
	Bus-Anschluss DALI Master Accoppiatore di bus DALI Master	78 x 78	95-250 50-60Hz	-	16	DALI BUS OUTPUT 35mA max	DALI	71-8069-00-00
	Tastenfeld DALI 4 Funktionen Pannello frontale DALI 4 funzioni	86 x 86 x 8,5	-	-	-	-	-	71-8070-00-00
	Tastenfeld DALI 9 Funktionen Pannello frontale DALI 9 funzioni	86 x 86 x 8,5	-	-	-	-	-	71-8071-00-00
		L x W x H mm	RGB White	V in F (Hz)	Luminarias máx.	W max	Protocol	Code
	DALI-Regler Regolatore DALI	80 x 80 x 53	White	100-240 50-60Hz	50	DALI BUS OUTPUT 100mA max	DALI	71-7671-00-00
	DMX Controller Controller DMX	86 x 86 x 42	RGB	100-240 50-60Hz	-	-	DMX	71-7666-00-00
	PWM controllers Contrôleurs PWM	86 x 86 x 32	RGB	12-24	-	240W @ 12V 480W @ 24V	PWM	71-7664-00-00
	DALI-Controller Controller DALI	86 x 86 x 42	White	100-240 50-60Hz	50	DALI BUS OUTPUT 100mA max	DALI	71-7665-00-00

	L x W x H mm	RGB White	V in	F (Hz)	W max	Protocol	Code
	140 x 48 x 17	White	Battery 3xAAA	869,5/916,5/434 MHz	-	RF	71-7670-00-00
	95 x 37 x 20	White	12-36	869,5/916,5/434 MHz	96W @ 12V 192W @ 24V	PWM	71-7668-00-00
	140 x 48 x 17	RGB	Battery 3xAAA	869,5/916,5/434 MHz	-	RF	71-7667-00-00
	178 x 46 x 22	RGB	12-48	869,5/916,5/434 MHz	240W @ 12V 480W @ 24V	PWM	71-7669-00-00

	W	V	F (Hz)	Code
	150	100-240V	50-60Hz	71-E069-00-00
	150	100-240V	50-60Hz	71-E070-00-00
	50	100-240V	50-60Hz	71-E011-00-00

Accesorios D4i One / Acessórios D4i One

	L x W x H mm	V in F (Hz)	Leuchten Apparecchi max.	Protocol	Code
	27 x 18	D4i	4 Drivers	D4i	71-A255-00-00
	66,4 x 32,7 x 11,5	Battery CR2032	-	IEEE 802.15.4	71-A262-00-00
	120 x 40 x 35	220-240V 50-60Hz	4 Drivers	D4i	35-A076-60-00
	48 x 45 x 40	220-240V 50-60Hz	4 Drivers	D4i	35-A076-14-00
	-	-	-	Software	71-A281-00-00

Electrical units & Accessories

Installationsempfehlung / Consigli per l'installazione

Produkte mit Remote-Treiber

Es wird empfohlen, den Treiber maximal 2 Meter vom Produkt entfernt zu installieren, wenn die in den geltenden Richtlinien festgelegten EMV-Werte für die entsprechende Anwendung nicht überprüft werden können. Die Polarität der Produktkabel muss überprüft werden, bevor der Anschluss an die Sekundärseite des Treibers erfolgt, da eine fehlerhafte Verbindung das LED-Modul und/oder den Treiber beschädigen kann.

Steuerung

Die Kabel für das Steuerungssignal müssen getrennt von den Stromkabeln installiert werden.

Es dürfen keine Schalter an der Sekundärseite des Treibers angebracht werden.

Steuerung nach Leitung (Phasenschnitt)

-Basissteuerung nach Leitung, keine zusätzlichen Kabel erforderlich.

-Produkte mit „L“-Dimmtreiber können mit Dimmern des Typs TRIAC/IGBT gedimmt werden; Steuerung durch Phasenschnitt.

-Produkte mit „C“-Dimmtreiber können mit IGBT-Dimmern gedimmt werden; Steuerung durch Phasenabschnitt.

-Produkte mit „LC“-Dimmtreiber können mit beiden zuvor angegebenen Dimmertypen verwendet werden.

-Es wird empfohlen, die Kompatibilität des Dimmtreibers zu überprüfen.

Push-Steuerung

Erfordert ein zusätzliches Kabel. Es müssen Druckschalter vom Typ NA (normalerweise offene) verwendet werden. Kurzes Drücken schaltet das Produkt ein oder aus. Durch Gedrückthalten des Schalters kann die Helligkeit eingestellt werden.

Steuerung 0/1–10 V

Analoge Steuerung, die zwei zusätzliche Kabel mit Polarität erfordert. Ein Dimmer erzeugt ein Signal bei konstanter Spannung zwischen 0 und 10 V. Bei einer Spannung von 1 V regelt der Treiber die Helligkeit des Produkts auf das Minimum herunter, bei einer Spannung von 10 V leuchtet das Produkt hingegen mit maximaler Helligkeit. Treiber, die ein Signal mit einem Bereich von 0 bis 10 V unterstützen, können das Produkt beim Empfang von 0 V durch den Dimmer vollständig abschalten.

DALI/DALI-2-Steuerung

Digitales Steuerprotokoll, das von den großen Treiberherstellern als Standard im Beleuchtungssektor entwickelt wurde. Ermöglicht die Speicherung von Szenen, das Senden von Nachrichten bei Ausfall oder Ende der Produktlebensdauer, eine punktweise Steuerung und Planung des Produkts sowie ein Notfallmanagement. Erfordert zwei zusätzliche Kabel ohne Polarität. Es wird ein Kabel mit einem Querschnitt von 1,5 mm² empfohlen. Die DALI-2-Zertifizierung verbessert die Kompatibilität mit DALI-Geräten.

DMX-Steuerung

Digitales Steuerprotokoll für spektakuläre Beleuchtungen. Erfordert zwei zusätzliche Kabel mit Polarität. Die Verwendung eines abgeschirmten, geflochtenen Kabels mit einer Impedanz von 120 Ω wird empfohlen.

Casambi-Steuerung

Bluetooth Mesh-Steuersystem

Der Abstand zwischen den Geräten sollte 15 m nicht überschreiten und es wird empfohlen, keine Metallabdeckungen zu verwenden, die die drahtlose Kommunikation beeinträchtigen.

Prodotti con driver remoto

Si consiglia di installare il driver a un massimo di 2 metri dal prodotto qualora non sia possibile verificare i livelli di compatibilità elettromagnetica (EMC) di ogni applicazione, come stabilito nelle norme di riferimento. È necessario verificare la polarità dei cavi del prodotto prima di collegarli al secondario del driver, poiché una connessione difettosa potrebbe danneggiare il modulo LED o il driver.

Regolazione

I cavi di segnale di regolazione devono essere installati separatamente dai cavi di alimentazione. Non è permesso installare interruttori nel secondario del driver.

Regolazione per linea (taglio di fase)

-Regolazione di base per linea: non richiede cavi aggiuntivi.

-Prodotti con driver di regolazione tipo „L“: supportano una regolazione con dimmer tipo TRIAC/IGBT; regolazione per inizio fase (leading edge/forward phase control).

-Prodotti con driver di regolazione tipo „C“: supportano una regolazione con dimmer tipo IGBT; regolazione di fine fase (trailing edge/reverse phase control).

-Prodotti con driver tipo „LC“ supportano i due tipi di dimmer sopra specificati.

-Si raccomanda di verificare la compatibilità dimmer-driver.

Regolazione Push

Richiede un cavo supplementare. Si devono usare pulsanti NA (normalmente aperti). Un pulsante rapido accende o spegne il prodotto. Se il pulsante viene mantenuto in funzione, il livello di luminosità può essere regolato.

Regolazione 0/1–10V

Regolazione analogica che richiede due cavi aggiuntivi con polarità. Un dimmer genera un segnale a tensione costante tra 0 e 10V. Se si applica una tensione di 1V, il driver regolerà la luminosità del prodotto al minimo; qualora venga applicata una tensione di 10V il prodotto brillerà al massimo. I driver che supportano un segnale di regolazione con intervallo tra 0-10V sono in grado di spegnere completamente il prodotto quando ricevono 0V dal dimmer.

Controllo DALI/DALI-2

Protocollo di controllo digitale sviluppato dai principali produttori di driver per creare uno standard di regolazione nel settore dell'illuminazione. Permette di memorizzare scene, inviare messaggi in caso di guasto o di fine vita del prodotto, controllo e pianificazione punto per punto del prodotto e gestione delle emergenze. Richiede due cavi supplementari senza polarità. Si consiglia di utilizzare un cavo sezione 1.5mm². La certificazione DALI-2 migliora l'interoperabilità tra dispositivi DALI.

Controllo DMX

Protocollo di controllo digitale utilizzato nel mondo dell'illuminazione per spettacoli. Richiede due cavi aggiuntivi con polarità. Si raccomanda l'uso di cavi intrecciati, schermati e dotati di impedenza.

Control Casambi

Sistema di controllo Bluetooth Mesh. Si consiglia di non superare i 15 m di distanza tra i dispositivi, né di utilizzare involucri metallici che limitino la loro comunicazione wireless.



BODENEINBAULEUCHTEN – DRAINAGE

Die Montageanweisungen und Anleitungen des Handbuchs für die Installation der Bodeneinbauleuchten sind unbedingt zu befolgen, um den bestmöglichen Betrieb der Beleuchtungskörper gewährleisten zu können.

1. Vermeiden Sie die Montage der Beleuchtungskörper in abschlüssigem Gelände.
2. Vermeiden Sie die Montage der Beleuchtungskörper in Bereichen der Wasseransammlung und in Feuchtzonen, wie Gärten und Rasenflächen.
3. Vermeiden Sie die Verwendung von chemischen Gartendüngemitteln, da diese einen schädlichen Einfluss auf einige der Komponenten ausüben können.
4. Bringen Sie den Beleuchtungskörper und den Bodenbelag auf eine Höhe.
5. Sorgen Sie beim Einbau der Beleuchtungskörper in Zement- oder Betonflächen für eine geeignete Ummantelung, um eine eventuelle Ausdehnung oder ein Zusammenpressen zu verhindern.
6. Bauen Sie ein wirksames Drainagesystem ein, um das Anstauen von Wasser zu vermeiden, wobei ein Kiesbett von mindestens 25 cm unter dem Einbaugeschäule vorhanden sein muss. Bei einer korrekten Drainage müssen bis zu 10 Liter Wasser in 15 Minuten absorbiert werden.
7. Nehmen Sie den Beleuchtungskörper 20 Minuten lang ohne Deckglas in Betrieb, um eine Kondensierung des Wassers im Inneren der Leuchte zu vermeiden.

ELEMENTI DA INCASSARE AL SUOLO - DRENAGGIO

È indispensabile seguire le istruzioni di montaggio e la guida di installazione degli elementi ad incasso, per garantire il migliore funzionamento possibile.

1. Evitare di collocare i faretto in zone depresse del terreno.
2. Evitare di collocare i faretto in zone in cui possa accumularsi acqua e in ubicazioni permanentemente umide, come giardini o prati.
3. Evitare l'uso dei prodotti chimici usati per la concimazione di giardini, visto che potrebbero deteriorare alcuni componenti del faretto.
4. Collocare il faretto al livello del suolo.
5. Prevedere una giunta di dilatazione nel caso di elementi ad incasso collocati in superfici come cemento e calcestruzzo, per evitare la possibile dilatazione o compressione.
6. Disporre un drenaggio efficace per evitare il ristagno dell'acqua, come minimo di 25 centimetri di ghiaia al di sotto della carcassa di installazione. Un drenaggio corretto deve assorbire fino a 10 litri di acqua in 15 minuti.
7. Far funzionare il faretto per 20 minuti, senza il vetro, per evitare che al suo interno si formi condensazione.

Drivers



L x W x H mm	IP	CLASS	Vin	Frequenz Frequenza	Vout	Ausgangsstrom Corrente d'uscita			W min	W max	Leistungsfaktor Fattore di potenza	Protocol	
						min	max	mA/mA					
103x67x21	20	□	110-240	50-60Hz	2-53	250	900	-	1,00	32,00	0,90	PUSH / 0-10V / 1-10V / CASAMBI	71-3475-00-00
124x79x22	20	□	110-240	50-60Hz	0-74	350	1050	-	0	50,00	0,95	-	71-3542-00-00
124x79x22	20	□	110-240	50-60Hz	2-74	350	1050	-	0,70	60,00	0,95	PUSH / 0-10V / 1-10V / DALI	71-4706-00-00
124x79x22	20	□	110-240	50-60Hz	2-74	350	1050	-	1,00	50,00	0,90	PUSH / 0-10V / 1-10V	71-4708-00-00
129x75x32	20	⊕	100-240	50-60Hz	29-58	-	-	700	20,30	40,00	0,90	-	71-4887-00-00
129x75x32	20	⊕	100-240	50-60Hz	22-44	-	-	900	19,80	40,00	0,90	-	71-4889-00-00
129x75x32	20	⊕	100-240	50-60Hz	25-50	-	-	1200	30,00	60,00	0,90	-	71-4891-00-00
129x75x32	20	⊕	100-240	50-60Hz	25-50	-	-	800	20,00	48,00	0,90	-	71-4896-00-00
166x47x35	20	□	220-240	50-60Hz	2-47	350	900	-	1,00	32,00	0,97	MAINS / PUSH	71-4898-00-00
153x54x36	20	□	220-240	50-60Hz	27-50	-	-	700	18,90	35,00	0,90	MAINS	71-4928-00-00
95x53x25	20	□	220-240	50-60Hz	18-38	-	-	350	6,30	13,00	0,95	MAINS	71-5272-00-00
110x52x22	20	□	110-240	50-60Hz	2-43	250	700	-	0,70	20,00	0,92	DALI	71-6192-00-00
85x40x22	20	□	220-240	50-60Hz	13-21	-	-	700	9,10	14,70	0,90	MAINS	71-6430-00-00
153x67x30	20	□	220-240	50-60Hz	38-57	-	-	700	28,00	39,90	0,90	MAINS	71-6431-00-00
123x45x19	20	□	100-240	50-60Hz	5-13	-	-	700	3,50	9,10	0,78	-	71-6651-00-00
123x45x19	20	□	100-240	50-60Hz	23-46	-	-	350	8,00	16,10	0,82	-	71-6652-00-00
105x68x32	20	□	100-240	50-60Hz	21-43	-	-	700	14,70	30,10	0,84	-	71-6653-00-00
105x68x32	20	□	100-240	50-60Hz	21-43	-	-	700	14,70	30,10	0,84	-	71-6654-00-00
115x29x45	20	□	100-240	50-60Hz	10-29	-	-	700	7,00	20,30	0,81	-	71-6658-00-00
115x45x29	20	□	100-240	50-60Hz	21-42	-	-	500	10,50	21,00	0,82	-	71-6659-00-00
105x68x32	20	□	100-240	50-60Hz	21-42	-	-	1050	22,05	44,10	0,87	-	71-6661-00-00
68x33x22	20	□	100-277	50-60Hz	8-13	-	-	350	2,80	4,00	0,40	-	71-7364-00-00
115x45x29	20	□	100-240	50-60Hz	21-42	-	-	500	10,50	21,00	0,82	-	71-7551-00-00
102x38x21	20	□	220-240	50-60Hz	6-14	-	-	700	4,20	10,00	0,96	MAINS	71-7663-00-00
103x34x19	20	□	100-240	50-60Hz	0-43	-	-	350	0,00	15,00	0,54	-	71-7701-00-00
110x52x22	20	□	100-240	50-60Hz	2-43	350	900	-	2,00	20,00	0,95	PUSH / 0-10V / 1-10V	71-7710-00-00
95x53x30	20	□	220-240	50-60Hz	18-36	-	-	500	9,00	18,00	0,95	MAINS	71-7711-00-00
68x33x22	20	□	100-277	50-60Hz	2,8-7	-	-	700	2,00	4,90	0,00	-	71-7712-00-00
50x40x22	20	□	90-264	50-60Hz	2-8,5	-	-	700	1,40	6,00	0,60	-	71-7713-00-00
95x53x30	20	□	220-240	50-60Hz	18-36	-	-	700	12,60	25,20	0,90	MAINS	71-7714-00-00
153x67x30	20	□	220-240	50-60Hz	28-40	-	-	900	28,00	40,00	0,90	MAINS	71-7715-00-00
153x67x30	20	□	220-240	50-60Hz	28-40	-	-	1000	28,00	40,00	0,00	MAINS	71-7716-00-00
129x75x32	20	⊕	100-240	50-60Hz	25-50	-	-	1200	25,00	70,00	0,90	1-10V	71-7717-00-00
129x75x32	20	⊕	100-277	50-60Hz	20-42	-	-	1200	24,00	50,00	0,90	DALI	71-7718-00-00
138x67x29,5	20	□	220-240V	50-60Hz	15-37	700	700	-	7,00	27,00	0,98	DALI / DALI D4i	71-7737-00-00
138x67x29,5	20	□	220-240V	20-60Hz	17-47	700	700	-	14,00	35,00	0,98	DALI / DALI D4i	71-7738-00-00
68x33x22	20	□	100-277	50-60Hz	2,8-7	-	-	500	1,40	3,50	0,50	-	71-8048-00-00
68x33x22	20	□	100-277	50-60Hz	2-7	-	-	350	0,70	2,45	0,40	-	71-8077-00-00
127x43x25	20	□	100-240V	50-60Hz	5-13	700	700	-	3,00	9,00	0,80	DALI	71-A190-00-00
127x43x25	20	□	100-240V	50-60Hz	23-46	350	350	-	80,00	16,00	0,80	PUSH / DALI	71-A191-00-00
152x46x36	20	□	100-240V	50-60Hz	10-43	350	700	-	7,00	30,00	0,80	PUSH / DALI	71-A192-00-00
146,5x44x30	20	□	220-240V	50-60Hz	10-38	350	1050	-	16,00	38,00	0,95	CASAMBI	71-A260-00-00
146,5x44x30	20	□	220-240V	50-60Hz	8-32	650	1400	-	5,00	45,00	0,95	CASAMBI	71-A261-00-00
121,5x53,5x26	68	□	99-264V	50-60Hz	2-49	350	350	-	1,00	17,00	0,96	-	71-E079-00-00
121,5x53,5x26	68	□	99-264V	50-60Hz	2-49	700	700	-	1,00	30,00	0,95	DALI	71-E080-00-00
121,5x53,5x26	68	□	99-264V	50-60Hz	2-24	700	700	-	1,00	17,00	0,95	PUSH / 0-10V	71-E081-00-00
135x80x31	68	□	99-264V	50-60Hz	10-50	350	350	-	3,50	70,00	0,95	PUSH / 0-10V / 1-10V	71-E083-00-00
135x80x31	68	□	99-264V	50-60Hz	10-50	500	500	-	3,50	70,00	0,95	0-10V / 1-10V	71-E085-00-00
135x80x31	68	□	99-264V	50-60Hz	10-50	700	700	-	3,50	70,00	0,95	0-10V / 1-10V	71-E086-00-00
103x67x21	20	□	110-240V	50-60Hz	3-48	250	700	-	2,00	32,00	0,95	DALI	71-E214-00-00
135x80x31	68	□	99-264V	50-60Hz	10-50	1400	1400	-	14,00	70,00	0,95	DALI	71-E216-00-00
130x38x28	20	□	110-240V	50-60Hz	2-14	1400	1400	-	2,80	18,00	0,60	MAINS	71-E217-00-00
115x34x19	20	□	90-264V	50-60Hz	1-41,5	60	360	-	0,00	15,00	0,64	MAINS	71-E218-00-00
110x52x22	20	□	110-240V	50-60Hz	10-53	100	380	-	1,00	20,00	0,95	DALI	71-E219-00-00
110x52x22	20	□	90-264V	50-60Hz	2-53	100	380	-	0,36	20,00	0,95	MAINS	71-E220-00-00
115x64x30	20	□	110-240V	50-60Hz	2-44	1050	2100	-	2,10	60,00	0,95	DALI	71-E221-00-00

IP67 Driver & Connector



W	mA	
10	700	71-E014-00-00
20	700	71-E015-00-00

Inklusive / Incluso



Stromversorgung / Fonte di alimentazione



L x W x H mm	IP	CLASS	V in	Frequenz Frequenza	V out	Ausgangsstrom Corrente d'uscita	W min	W max	Leistungsfaktor Fattore di potenza	
270x40x23	67	□	120-277	47-63Hz	12V	DC	10,00	100,00	>0,90	71-3479-00-00
300x44x23	20	□	120-277	47-63Hz	24V	DC	10,00	96,00	>0,90	71-5487-00-00
167x38x29	20	□	100-240	47-63Hz	12V	DC	-	20,00	>0,90	71-5489-00-00
220x40x21	20	□	100-277	50-60Hz	24V	DC	3,50	35,00	>0,95	71-6339-00-00
250x40x21	20	□	100-277	50-60Hz	24V	DC	4,80	60,00	>0,95	71-6340-00-00
202x71,2x45	67	⊕	100-240	50-60Hz	24V	DC	-	100,00	>0,97	71-6341-00-00
225x60x36	20	□	220-240	50-60Hz	24V	DC	-	70,00	>0,97	71-6342-00-00
240x60x49	20	□	220-240	50-60Hz	24V	DC	-	150,00	>0,98	71-6343-00-00
244x71,2x45	67	⊕	100-240	50-60Hz	24V	DC	-	150,00	>0,95	71-6344-00-00
244x71x37,5	67	⊕	100-305	50-60Hz	24V	DC	-	240,00	>0,97	71-6345-00-00
252x90x43,8	67	⊕	100-305	50-60Hz	24V	DC	-	320,00	>0,98	71-6346-00-00
180x52x30	20	□	220-240	50-60Hz	48V DC	0 min 1,50A max	-	75,00	0,95	71-A258-00-00
300x40x30	20	□	220-240	50-60Hz	48V DC	0 min 2,50A max	-	120,00	0,95	71-A259-00-00
150x53x35	67	□	90-305	47-63Hz	24V DC	1,67A	8,00	40,08	0,95	71-E094-00-00
150x53x35	67	□	90-305	47-63Hz	24V DC	2,50A	10,00	60,00	0,90	71-E096-00-00
191x63x37,5	67	□	90-305	50-60Hz	24V DC	5,00A	24,00	120,00	0,90	71-E097-00-00
150x53x35	67	□	90-305	47-63Hz	24V DC	2,50A	-	60,00	0,95	71-E098-00-00
191x63x37,5	67	□	90-305	50-60Hz	24V DC	5,00A	24,00	120,00	0,96	71-E099-00-00
152xØ46	65	□	100-240	50-60Hz	24V DC	0,40min 0,84A max	-	20,16	0,90	71-E101-05-05
152xØ46	65	□	100-240	50-60Hz	24V DC	0,40min 0,84A max	-	20,16	0,90	71-E101-05-05
148x40x32	67	□	90-305	50-60Hz	24V	DC	5,00	25,00	>0,92	71-E158-00-00
162,5x40x32	67	□	90-305	50-60Hz	24V	DC	10,00	60,00	>0,92	71-E159-00-00

Stromwandler / Trasformatore

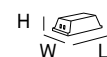

□ ⊕ 12V AC

L x W x H mm	IP	V in	Frequenz Frequenza	V out	Ausgangsstrom Corrente d'uscita	W min	W max	Leistungsfaktor Fattore di potenza	Protocol	
160xØ120	68/1mt	220-240	50Hz	12	AC	MAGNETIC	-	100		71-9197-05-05
128x37x28	20	220-240	50-60Hz	12	AC	ELECTRONIC	20	70	>0,9	MAINS ACT-TRA-002

Controller / Apparecchi di controllo

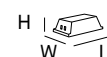

□ IP20 ⊕

L x W x H mm	IP	CLASS	V in	DC V out	W max x canal	W max total	Protocol		
153x65x20	20	□	12V DC 24V DC	12 24	30 60	60 120	1-10V	2	71-0727-00-00
172x42x19	20	□	12V DC 24V DC	12 24	- -	60 120	DALI	-	71-3473-00-00
153x65x20	20	□	12V DC 24V DC	12 24	24 48	96 192	DMX	4	71-3493-00-00
219x63x36	20	□	100-305 VAC	24	-	150	DALI	-	71-7708-00-00
191x63x37,5	67	□	90-305V 47-63Hz	24	120	120	PWM	-	71-A242-00-00

Verstärker RGB-White / Amplificatore RGB-White



□ IP20 ⊕

L x W x H mm	VDC in	W max x canal	W max total		
153x65x20	12 24	48 96	192 384	4	71-1553-00-00

Tabelle zur Auswahl der Netzgeräte und Controller

Tabella per la selezione delle fonti di alimentazione e dei controller

									Netzteil nicht dimmbar Alimentazione non regolabile																		
									Referenz Codice	71-5489	71-3479	71-E158	71-6339	71-6340	71-E159	71-6342	71-5487	71-6341	71-6343	71-6344	71-6345	71-6346	71-E094	71-E096	71-E097		
									Versorgungsspannung Tensione dell'alimentazione (Vin)	100-240	108-305	90-305	90-305	90-305	90-305	198-264	120-277	100-240	198-264	90-295	100-305	90-305	100-305VAC	100-305VAC	100-305VAC		
									Ausgangsspannung Tensione di uscita (Vout)	12VDC			24VDC											24VDC	24VDC	24VDC	
									P (W)	20	100	25	35	60	60	75	96	100	150	150	240	320	40	60	120		
									IP	20	67	67	20	20	67	20	20	67	20	67	67	67	67	67	67		
									SEITE / PAG.	359	359	359	359	359	359	359	359	359	359	359	359	359	359	359	359		
Referenz Codice	Name Nome	Kelvin	CRI	W	Spannung / Volt.	L(m)	W/m	Schnitt min. Taglio Min (mm)	Maximale LED-Streifenlänge, die mit einem Treiber gesteuert werden kann Massimo di metri di strip che possono essere alimentati per driver																		
91-7908	BASIC 4,8	2700	80	24	24	5	4,8	100				5	6	11	11	14	18	18	28	28	45	59	7	11	23		
91-7909		3000	80	24	24	5	4,8	100				5	6	11	11	14	18	18	28	28	45	59	7	11	23		
91-7910		4000	80	24	24	5	4,8	100				5	6	11	11	14	18	18	28	28	45	59	7	11	23		
91-7911		6000	80	24	24	5	4,8	100				5	6	11	11	14	18	18	28	28	45	59	7	11	23		
91-7912		2700	80	24	24	5	4,8	100				5	6	11	11	14	18	18	28	28	45	59	7	11	23		
91-7913		3000	80	24	24	5	4,8	100				5	6	11	11	14	18	18	28	28	45	59	7	11	23		
91-7914		4000	80	24	24	5	4,8	100				5	6	11	11	14	18	18	28	28	45	59	7	11	23		
91-7915		6000	80	24	24	5	4,8	100				5	6	11	11	14	18	18	28	28	45	59	7	11	23		
91-3282	BASIC 9,6	2500	80	48	24	5	9,6	50				2	3	5	5	6	9	9	14	14	23	30	4	5	11		
91-7916		2700	80	48	24	5	9,6	50				2	3	5	5	6	9	9	14	14	23	30	4	5	11		
91-7917		3000	80	48	24	5	9,6	50				2	3	5	5	6	9	9	14	14	23	30	4	5	11		
91-7918		4000	80	48	24	5	9,6	50				2	3	5	5	6	9	9	14	14	23	30	4	5	11		
91-7919		6000	80	48	24	5	9,6	50				2	3	5	5	6	9	9	14	14	23	30	4	5	11		
91-7920		RGB		48	24	5	9,6	100				2	3	5	5	6	9	9	14	14	23	30					
91-7921		2700	80	48	24	5	9,6	50				2	3	5	5	6	9	9	14	14	23	30	4	5	11		
91-7922		3000	80	48	24	5	9,6	50				2	3	5	5	6	9	9	14	14	23	30	4	5	11		
91-7923		4000	80	48	24	5	9,6	50				2	3	5	5	6	9	9	14	14	23	30	4	5	11		
91-7924		6000	80	48	24	5	9,6	50				2	3	5	5	6	9	9	14	14	23	30	4	5	11		
91-7925	RGB		48	24	5	9,6	100				2	3	5	5	6	9	9	14	14	23	30						
91-7926	BASIC 14,4	2700	80	72	24	5	14,4	50				1	2	4	4	5	5	5	9	9	14	20	2	4	7		
91-7927		3000	80	72	24	5	14,4	50				1	2	4	4	5	5	5	9	9	14	20	2	4	7		
91-2379		RGB		72	24	5	14,4	100				1	2	4	4	5	5	5	9	9	14	20					
91-7928	BASIC 19,2	2700	80	96	24	5	19,2	62,5				1	1	3	3	3	5	5	6	6	11	14	2	3	5		
91-7929		3000	80	96	24	5	19,2	62,5				1	1	3	3	3	5	5	6	6	11	14	2	3	5		
91-5567		3000	80	96	24	5	19,2	50				1	1	3	3	3	5	5	6	6	11	14	2	3	5		
91-5571	BASIC 28,8	2700	80	144	24	5	28,8	50					1	2	2	2	3	3	5	5	7	10	1	2	4		
91-5572		3000	80	144	24	5	28,8	50					1	2	2	2	3	3	5	5	7	10	1	2	4		
91-5573		4000	80	144	24	5	28,8	50					1	2	2	2	3	3	5	5	7	10	1	2	4		
91-7930	PERFORMANCE 9,6	2700	90	48	24	5	9,6	50				2	3	5	5	6	9	9	14	14	23	30	4	5	11		
91-7931		3000	90	48	24	5	9,6	50				2	3	5	5	6	9	9	14	14	23	30	4	5	11		
91-7932	PERFORMANCE 14,4	2700	90	72	24	5	14,4	50				1	2	4	4	5	5	5	9	9	14	20	2	4	7		
91-7933		3000	90	72	24	5	14,4	50				1	2	4	4	5	5	5	9	9	14	20	2	4	7		







Dimmbare Netzteile und Controller Sorgenti e controller regolabili								Empfänger mit Fernbedienung Ricevitore con telecomando				Steuerungen zur Wandmontage Controllers a parete		Casambi-PWM-Modul mit vier Kanälen Modulo Casambi PW 4 canali		Casambi-PWM-Modul mit einem Kanal Modulo Casambi PWM 1 canale	
	1-10V	DALI PUSH	DALI	DALI	DALI	Verstärker Amplificatore	DMX										
	71-0727	71-3473	71-E098	71-E099	71-7708	71-1553	71-3493	71-7669	71-7668	71-7667	71-7670	71-7664	71-8050	71-A242			
	12/24 Vdc	12/24 Vdc	100-305VAC	100-305VAC	100-305VAC	12/24 Vdc	12/24 Vdc	12/24 Vdc	12/24 Vdc			12/24VDC	12/24VDC	90-305VAC			
	12/24 VDC	12/24 VDC	24 VDC	24 VDC	24 VDC	12/24 VDC	12/24 VDC	12/24 VDC	12/24 VDC			12/24VDC	12/24VDC	24VDC			
	2x (78/156)	60/120	60	120	150	4x4A	4x2A	4x5A	96/192			4x5A	6A	120			
	20	20	67	67	67	20	20	20	20			20	20	67			
	359	359	359	359	359	359	359	83	83	83	83	81	59	60			
Maximale LED-Streifenlänge, die mit einem Treiber gesteuert werden kann Massimo di metri di strip che possono essere alimentati per driver								Maximale LED-Streifenlänge, die mit einem Treiber gesteuert werden kann Massimo di metri di strip che possono essere alimentati per driver				Maximale LED-Streifenlänge, die mit einem Treiber gesteuert werden kann Massimo di metri di strip che possono essere alimentati per driverchaque dispositif		Maximale LED-Streifenlänge, die mit einem Treiber gesteuert werden kann Massimo di metri di strip che possono essere alimentati per driverchaque dispositif		Maximale LED-Streifenlänge, die mit einem Treiber gesteuert werden kann Massimo di metri di strip che possono essere alimentati per driverchaque dispositif	
	59	23	11	23	28			36					28	23			
	59	23	11	23	28			36					28	23			
	59	23	11	23	28			36					28	23			
	59	23	11	23	28			36					28	23			
	59	23	11	23	28			36					28	23			
	59	23	11	23	28			36					28	23			
	59	23	11	23	28			36					28	23			
	29	11	5	11	14			18					14	11			
	29	11	5	11	14			18					14	12			
	29	11	5	11	14			18					14	12			
	29	11	5	11	14			18					14	12			
	29	11	5	11	14			18					14	12			
						27	14	33				33	14	12			
	29	11	5	11	14			18					14	12			
	29	11	5	11	14			18					14	12			
	29	11	5	11	14			18					14	12			
	29	11	5	11	14			18					14	12			
						27	14	33				33	14	12			
	19	7	4	7	9			12					9	8			
	19	7	4	7	9			12					9	8			
						18	9	22				22	9	6			
	14	5	3	5	6			9					7	6			
	14	5	3	5	6			9					7	6			
	14	5	3	5	6			9					7	6			
	9	4	2	4	5			6					4	4			
	9	4	2	4	5			6					4	4			
	9	4	2	4	5	9	5	6					4	4			
	29	11	5	11	14			18					14	12			
	29	11	5	11	14			18					14	12			
	19	7	4	7	9			12					9	8			
	19	7	4	7	9			12					9	8			

Tabelle zur Auswahl der Netzgeräte und Controller

Tabella per la selezione delle fonti di alimentazione e dei controller

										Netzteil nicht dimmbar Alimentazione non regolabile																	
										Referenz Codice	71-5489	71-3479	71-E158	71-6339	71-6340	71-E159	71-6342	71-5487	71-6341	71-6343	71-6344	71-6345	71-6346	0-10V	0-10V	0-10V	
										Versorgungsspannung Tensione dell'alimentazione (Vin)	100-240	108-305	90-305	90-305	90-305	90-305	198-264	120-277	100-240	198-264	90-295	100-305	90-305	100-305VAC	100-305VAC	100-305VAC	
										Ausgangsspannung Tensione di uscita (Vout)	12V		24V										24VDC	24VDC	24VDC		
										P (W.)	20	100	25	35	60	60	75	96	100	150	150	240	320	40	60	120	
										IP	20	67	67	20	20	67	20	20	67	20	67	67	67	67	67	67	67
										SEITE / PAG.	359	359	359	359	359	359	359	359	359	359	359	359	359	359	359	359	359
Referenz Codice	Name Nome	Kelvin	CRI	W	Spannung / Volt.	L(m)	W/m	Schnitt min. (mm) Taglio Min (mm)	Maximale LED-Streifenlänge, die mit einem Treiber gesteuert werden kann Massimo di metri di strip che possono essere alimentati per driver																		
91-7934	PERFORMANCE 19,2	2700	90	96	24	5	19,2	62,5			1	1	3	3	3	5	5	6	6	11	14	2	3	5			
91-7935		3000	90	96	24	5	19,2	62,5			1	1	3	3	3	5	5	6	6	11	14	2	3	5			
91-7936		4000	90	96	24	5	19,2	62,5			1	1	3	3	3	5	5	6	6	11	14	2	3	5			
91-7937		RGB		72	24	5	14,4	71			1	2	4	4	5	5	5	9	9	14	20						
91-7938		RGBW	90(W)	96	24	5	19,2	125			1	1	3	3	3	5	5	6	6	11	14						
91-7939		2500-6000	90	96	24	5	19,2	125			1	1	3	3	3	5	5	6	6	11	14						
91-7940	PERFORMANCE 28,8	2700	90	144	24	5	28,8	42				1	2	2	2	3	3	5	5	7	10	1	2	4			
91-7941		3000	90	144	24	5	28,8	42				1	2	2	2	3	3	5	5	7	10	1	2	4			
91-7942	ADVANCED CRI98	2700	98	75	24	5	14,9	62,5			1	2	4	4	5	5	5	9	9	14	19	2	4	7			
91-7943		3000	98	75	24	5	14,9	62,5			1	2	4	4	5	5	5	9	9	14	19	2	4	7			
91-7944	ADVANCED 160	2700	80	48	24	5	9,6	50			2	3	5	5	6	9	9	14	14	23	30	4	5	11			
91-7945		3000	80	48	24	5	9,6	50			2	3	5	5	6	9	9	14	14	23	30	4	5	11			
91-7946	ADVANCED THIN	2700	90	48	24	5	9,6	50			2	3	5	5	6	9	9	14	14	23	30	4	5	11			
91-7947		3000	90	48	24	5	9,6	50			2	3	5	5	6	9	9	14	14	23	30	4	5	11			
91-7948	ADVANCED HIGH DENSITY	2700	90	72	24	5	14,4	25			1	2	4	4	5	5	5	9	9	14	20	2	4	7			
91-7949		3000	90	72	24	5	14,4	25			1	2	4	4	5	5	5	9	9	14	20	2	4	7			
91-7950	ADVANCED DOUBLE LED	2700	90	96	24	5	19,2	50			1	1	3	3	3	5	5	6	6	11	14	2	3	5			
91-7951		3000	90	96	24	5	19,2	50			1	1	3	3	3	5	5	6	6	11	14	2	3	5			
91-A000/02	ASAI 3D	3000/4000	80	14	24	1	14,4	Max, 1 cut			1	2	4	4	5	5	5	9	9	14	20	2	4	7			
91-A001/03		3000/4000	80	115,2	24	8	14,4	Max, 1 cut			1	2	4	4	5	5	5	9	9	14	20	2	4	7			
91-A004		RGB	80	14,4	24	1	14,4	Max, 1 cut			1	2	4	4	5	5	5	9	9	14	20						
91-A005		RGB	80	115,2	24	8	14,4	Max, 1 cut			1	2	4	4	5	5	5	9	9	14	20						
91-6607	ASAI SIDE BEND	3000	80	14,4	24	1	14,4	Max, 1 cut			1	2	4	4	5	5	5	9	9	14	20	2	4	7			
91-7964		4800	80	14,4	24	1	14,4	Max, 1 cut			1	2	4	4	5	5	5	9	9	14	20	2	4	7			
91-7968		RGB		14,4	24	1	14,4	Max, 1 cut			1	2	4	4	5	5	5	9	9	14	20						
91-6608		3000	80	115,2	24	8	14,4	Max, 1 cut			1	2	4	4	5	5	5	9	9	14	20	2	4	7			
91-7965		4800	80	115,2	24	8	14,4	Max, 1 cut			1	2	4	4	5	5	5	9	9	14	20	2	4	7			
91-7969		RGB		115,2	24	8	14,4	Max, 1 cut			1	2	4	4	5	5	5	9	9	14	20						
91-6609	ASAI TOP BEND	3000	80	14,4	24	1	14,4	Max, 1 cut			1	2	4	4	5	5	5	9	9	14	20	2	4	7			
91-7966		4800	80	14,4	24	1	14,4	Max, 1 cut			1	2	4	4	5	5	5	9	9	14	20	2	4	7			
91-7970		RGB		14,4	24	1	14,4	Max, 1 cut			1	2	4	4	5	5	5	9	9	14	20						
91-6610		3000	80	115,2	24	8	14,4	Max, 1 cut			1	2	4	4	5	5	5	9	9	14	20	2	4	7			
91-7967		4800	80	115,2	24	8	14,4	Max, 1 cut			1	2	4	4	5	5	5	9	9	14	20	2	4	7			
91-7971	RGB		115,2	24	8	14,4	Max, 1 cut			1	2	4	4	5	5	5	9	9	14	20							















Dimmbare Netzteile und Controller Sorgenti e controller regolabili								Empfänger mit Fernbedienung Ricevitore con telecomando				Steuerungen zur Wandmontage Controllers a parete		Casambi-PWM-Modul mit vier Kanälen Modulo Casambi PW 4 canali		Casambi-PWM-Modul mit einem Kanal Modulo Casambi PWM 1 canale	
	1-10V	DALI PUSH	DALI	DALI	DALI	Verstärker Amplificatore	DMX										
	71-0727	71-3473	71-E098	71-E099	71-7708	71-1553	71-3493	71-7669	71-7668	71-7667	71-7670	71-7664	71-8050	71-A242			
	12/24 Vdc	12/24 Vdc	100-305VAC	100-305VAC	100-305 Vdc	12/24 Vdc	12/24 Vdc	12/24 Vdc	12/24 Vdc			12/24Vdc	12/24Vdc	90-305VAC			
	12/24V		24VDC	24VDC	24V	12/24V	12/24V	12/24V	12/24V			12/24V	12/24V	24VDC			
	2x (78/156)	60/120	60	120	150	4x4A	4x2A	4x5A	96/192			4x5A	6A	120			
	20	20	67	67	67	20	20	20	20			20	20	67			
	359	359	359	359	359	359	359	83	83	83	83	81	59	60			
Maximale LED-Streifenlänge, die mit einem Treiber gesteuert werden kann Massimo di metri di strip che possono essere alimentati per driver								Maximale LED-Streifenlänge, die mit einem Treiber gesteuert werden kann Massimo di metri di strip che possono essere alimentati per driver				Maximale LED-Streifenlänge, die mit einem Treiber gesteuert werden kann Massimo di metri di strip che possono essere alimentati per driverchaque dispositif		Maximale LED-Streifenlänge, die mit einem Treiber gesteuert werden kann Massimo di metri di strip che possono essere alimentati per driverchaque dispositif		Maximale LED-Streifenlänge, die mit einem Treiber gesteuert werden kann Massimo di metri di strip che possono essere alimentati per driverchaque dispositif	
	14	5	3	5	6				9				7	6			
	14	5	3	5	6				9				7	6			
	14	5	3	5	6				9				7	6			
						19	10	23					9				
						19	10	23					7				
						10	5						7				
	9	4	2	4	5				6				4	4			
	9	4	2	4	5				6				4	4			
	18	7	4	7	9				11				9	7			
	18	7	4	7	9				11				9	7			
	29	11	5	11	14				18				14	12			
	29	11	5	11	14				18				14	12			
	29	11	5	11	14				18				14	12			
	29	11	5	11	14				18				14	12			
	19	7	4	7	9				12				9	8			
	19	7	4	7	9				12				9	8			
	14	5	3	5	6				9				7	6			
	14	5	3	5	6				9				7	6			
	19	7	4	7	9				12				9	8			
	19	7	4	7	9				12				9	8			
						20	10	22					9				
						20	10	22					9				
	19	7	4	7	9				12				9	8			
	19	7	4	7	9				12				9	8			
						18	9	22					9	8			
	19	7	4	7	9				12				9	8			
	19	7	4	7	9				12				9	8			
						18	9	22					9	8			
	19	7	4	7	9				12				9	8			
	19	7	4	7	9				12				9	8			
						18	9	22					9	8			
	19	7	4	7	9				12				9	8			
	19	7	4	7	9				12				9	8			
						18	9	22					9	8			















Tabelle zur Auswahl der Netzgeräte und Controller

Tabella per la selezione delle fonti di alimentazione e dei controller

















		Netzteil nicht dimmbar Alimentazione non regolabile																						
																0-10V	0-10V	0-10V						
																71-E094	71-E096	71-E097						
																100-305VAC	100-305VAC	100-305VAC						
																24VDC	24VDC	24VDC						
																40	60	120						
																67	67	67						
		SEITE / PAG.														359	359	359						
Referenz Codice	Name Nome	Kelvin	W	Spannung Volt.	M. (mm)	Produkteinheiten, die jedes Gerat versorgen kann Unita di prodotto che possono essere alimentate da ogni dispositivo																		
05-E001	Tron	3000/4000	24	24	510					1	1	2	2	3	4	4	6	6	10	12	1	2	5	
05-E000		RGB	29,2	24	510						1	2	2	2	3	3	5	5	8	10				
05-E003		3000/4000	48	24	1005							1	1	1	2	2	3	3	5	6		1	2	
05-E002		RGB	55,9	24	1005							1	1	1	1	1	2	2	4	5				
55-E034	Taglio surface	3000/4000	9,6	24	1000			2	3	5	5	6	9	9	14	14	24	31	4	5	11			
55-E071		RGB	9,6	24	1000			2	3	5	5	6	9	9	14	14	24	31						
55-E004	Taglio recessed	3000/4000	14,7	24	1004			1	2	4	4	5	6	6	10	10	15	20	2	4	7			
55-E005		RGB	15,4	24	1004			1	2	3	3	4	5	5	8	8	14	19						
55-E076		3000/4000	7,8	24	1004			3	4	6	6	8	11	11	18	18	29	5	6	14				
55-E162	Taglio optics recessed	3000/4000	4	24	110			5	7	14	14	17	23	24	9	14	27							
55-E163		3000/4000	19	24	504			1	1	3	3	3	5	5	6	6	11	15	2	3	5			
05-E152	Thor	3000	4,1	24	small			5	7	13	13	17	22	23										
05-E153		3000	4,8	24	medium			5	6	11	11	14	19	19	29	29								
05-E154		3000	9,4	24	big			2	3	5	5	6	9	9	14	14	24	4	5	11				
05-E007/8		3000	4,1	24	small			5	7	13	13	17	22	23										
05-E009/10		3000	4,8	24	medium			5	6	11	11	14	19	19	29	29								
05-E011/13		3000	9,4	24	big			2	3	5	5	6	9	9	14	14	24	4	5	11				
55-E148	Ios	3000	4,1	24				5	7	13	13	17	22	23										
55-E149		3000	4,2	24				5	7	13	13	16	21	22										
55-E150		3000	6,3	24				3	5	8	8	10	14	14	22	22								
55-E151	Rim	3000/4000/Blue	1,5	24	D46			14	21									23	30					
55-E006		3000/4000	0,5	24	D20			45										30						
55-9823	Gea RGB DMX	RGB	6	24				4	5	9	9	11	14	14	23	23	30							
55-9825		RGB	26,1	24					1	2	2	2	3	3	5	5	9	11						
05-9889	AQUA Spotlight AISI 316	3000/4000	5	12		3	18																	
05-9728	AQUA Spotlight PC	4000	21	12			4																	
55-9792	AQUA Recessed AISI 316	4000	5	12		3	18																	
55-9768	GEA Led Signaling	4000 (+3000K filters)	0,5	12		36																		
55-9769		1	12		18																			
05-E093	MEX	2700+4000	6,7	24				3	5	7	7	10	13	13	21	21	30	5	7	15				
05-E094		RGBW	9,8	24				2	3	5	5	6	8	9	14	14	23	30						
05-E095		2700+4000	13,4	24				1	2	4	4	5	6	6	10	10	16	22	2	4	7			
05-E096		RGBW	24	24				1	1	2	2	3	4	4	6	6	10	12						
55-E001	PIXEL	3000/4000	3,4	24	1w			6	9	15	15	20	25	26	30				10	15	30			
55-E002		3000/4000	3,4	24	2w			6	9	15	15	20	25	26	30				10	15	30			
55-E003		3000/4000	3,4	24	4w			6	9	15	15	20	25	26	30				10	15	30			
55-E117	VERCLE	3000	20,8	24				1	1	2	2	3	4	4	6	6	10	14	1	2	5			
55-E118		3000	35,3	24						1	1	2	2	2	4	4	6	9	1	1	3			
55-E119		3000	8,3	24				3	4	6	6	8	10	11	16	17	27	30	4	6	13			
55-E120		3000	34,3	24				1	1	1	2	2	2	4	4	6	9	1	1	3				

Dimmbare Netzteile und Controller Sorgenti e controller regolabili								Empfänger mit Fernbedienung Ricevitore con telecomando				Steuerungen zur Wandmontage Controllers a parete	Casambi-PWM-Modul mit vier Kanälen Modulo Casambi PW 4 canali	Casambi-PWM-Modul mit einem Kanal Modulo Casambi PWM 1 canale
	1-10V	DALI PUSH	DALI	DALI	DALI	Verstärker Amplificatore	DMX							
	71-0727	71-3473	71-E098	71-E099	71-7708	71-1553	71-3493	71-7669	71-7668	71-7667	71-7670	71-7664	71-8050	71-A242
	12/24 Vdc	12/24 Vdc	100-305VAC	100-305VAC	100-305VAC	12/24 Vdc	12/24 Vdc	12/24 Vdc	12/24 Vdc			12/24Vdc	12/24Vdc	90-305VAC
	12/24V	12/24V	24VDC	24VDC	24V	12/24V	12/24V	12/24V	12/24V			12/24V	12/24V	24VDC
	2x (78/156)	60/120	60	120	150	4x4A	4x2A	4x5A	96/192			4x5A	6A	120
	20	20	67	67	67	20	20	20	20			20	20	67
	359	359	359	359	359	359	359	83	83	83	83	81	59	60
Produkteinheiten, die jedes Gerät versorgen kann Unita di prodotto che possono essere alimentate da ogni dispositivo								Produkteinheiten, die jedes Gerät versorgen kann Unita di prodotto che possono essere alimentate da ogni dispositivo				Produkteinheiten, die jedes Gerät versorgen kann Unita di prodotto che possono essere alimentate da ogni dispositivo	Produkteinheiten, die jedes Gerät versorgen kann Unita di prodotto che possono essere alimentate da ogni dispositivo	Produkteinheiten, die jedes Gerät versorgen kann Unita di prodotto che possono essere alimentate da ogni dispositivo
	5	5	2	5	5				7				5	4
						8	4	11				11	4	
	3	2	1	2	3	5	2		3				2	2
								5				6	2	
	14	11	5	11	14				18				14	11
						27	14	30				35	14	
	9	7	4	7	9				11				9	7
						16	8	21				22	8	
	18	14	6	14	17				22				18	14
	35	27	14	27	33				30				30	28
	7	5	3	5	6				9				7	6
	14	11	5	11	14				18				15	12
	14	11	5	11	14				18				15	12
	30	30	30						30				30	30
	30	30	30						30				30	30
	20	15	7	15	20				25				21	17
						20	18	20				20	14	
	10	7	4	7	10				12				10	8
						15	8	19				19	5	
	30	30	15	30					30				30	30
	30	30	15	30					30				30	30
	30	30	15	30					30				30	30
	6	5	2	5	6				8				6	5
	4	3	1	3	4				4				3	3
	16	13	6	13	16				20				17	13
	4	3	1	3	4				5				4	3















Zubehör / Accessori

	Anschluss für Verbindung mit Hängeleuchten an Schienensystem Connettore per il collegamento delle sospensioni su binario	71-2232 - 14 - 14 ○ 60 - 60 ●
	Aufhängeset Kit sospensione	71-3223 - 14 - 00 ○ 60 - 00 ●
	Kabel für die Synchronisierung von Slave-Reglern Cavo per sincronizzazione, fornito separatamente	71-3476 - 00 - 00 ○ 71-4707
	Schienensteckverbinder Connettore per binario	71-3531 - 60 - 00 ●
	24°-Reflektor Riflettore 24°	71-3887 - 00 - 00 ○
	60°-Reflektor Riflettore 60°	71-3888 - 00 - 00 ○
	Visueller Komfort Comfort visivo	71-4754 - 60 - 00 ● 14 - 00 ○
	Wabenraster (1 VPE=5 Stk.) Pannello a nido d'ape (5 unità)	71-5166 71-E131 - 60 - 00 ● 71-E263
	Elliptischer Diffusor (1 VPE=5 Stk.) Diffusore ellittico (5 unità)	71-5167 - 00 - 00 ○
	Aufhängeset 1500 mm Kit sospensione 1500mm	71-5174 - 14 - 00 ○ 60 - DU ○ 60 - 60 ● DU ●
	Installationsset Strahler Aufputz Kit installazione proiettore di superficie	71-5175 - 14 - 00 ○ 60 - DU ○ 60 - 60 ● DU ●
	Zubehör Wabenplatte Accessorio pannello d'ape	71-5201 - 60 - 00 ● 71-A177
	Unterputzset 1000 mm Kit da incasso 1000mm	71-5511 - 00 - 00 ○
	Unterputzkappe Tappo incassato	71-5608 - 14 - 00 ○
	Unterputzkappe Tappo incassato	71-5609 - 14 - 00 ○















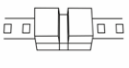

Zubehör / Accessori

	Beton-Unterputzset 36 Kit incasso in cemento 36	71-5617 - 60 - 00 ●
	Beton-Unterputzset 40-42 Kit incasso in cemento 40-42	71-5618 - 60 - 00 ●
	Vorderring Weiß Anello frontale bianco	71-5630 - 14 - 00 ○
	Zubehör elliptischer Diffusor Accessorio diffusore ellittico	71-5646 - 60 - 00 ● 71-8226 - 00
	Zubehör quadratischer Diffusor Accessorio diffusore quadrato	71-5647 - 60 - 00 ● 71-8224 - 00
	Quadratischer Diffusor (1 VPE=5 Stk.) Diffusore quadrato (5 unità)	71-5658 - 00 - 00 ○
	Kappe 19 mm mit Rahmen Tappo 19mm con cornice	71-5765 - 14 - 00 ○
	Kappe 19 mm ohne Rahmen Tappo 19mm senza cornice	71-5766 - 14 - 00 ○
	Kappe 35 mm mit Rahmen Tappo 35mm con cornice	71-5767 - 14 - 00 ○
	Kappe 35 mm ohne Rahmen Tappo 35mm senza cornice	71-5768 - 14 - 00 ○
	Kappe 50 mm ohne Rahmen Tappo 50mm senza cornice	71-5770 - 14 - 00 ○
	Unterputzset 1000 mm ohne Rahmen Kit da incasso 1000mm senza cornice	71-5786 - 00 - 00 ○
	Unterputzset 1000 mm ohne Rahmen Kit da incasso 1000mm senza cornice	71-5787 - 00 - 00 ○
	Unterputzset 1000 mm ohne Rahmen Kit da incasso 1000mm senza cornice	71-5788 - 00 - 00 ○
	Unterputzset 1000 mm ohne Rahmen Kit da incasso 1000mm senza cornice	71-5789 - 00 - 00 ○
	Weichzeichnerlinse (1 VPE=5 Stk.) Sagomatore di fascio (5 unità)	71-6099 71-6275 71-6281 - 00 - 00 ○ 71-6287 71-7893

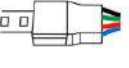

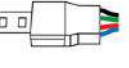

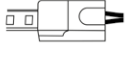









Zubehör / Accessori

	5 x Wabenraster 5 x Pannello a nido d'ape	71-6273 71-6279 71-6285 - 60 - 00 ● 71-7892 71-A854 71-A855
	5 x Elliptischer Diffusor 5 x Diffusore ellittico	71-6274 71-6289 - 00 - 00 ○ 71-6286 71-7891
	Visueller Komfort Comfort visivo	71-6276 71-6282 - 60 - 00 ● 14 - 00 ○ 71-6288
	Blende Visiera	71-6277 71-6283 - 60 - 00 ● 71-6289
	Blendschutzflügel Alette antiriflesso	71-6290 - 60 - 00 ● 14 - 00 ○
	Vorderring Anello frontale	71-6436 71-6437 - 23 - 00 ○ 14 - 00 ○ 71-6438
	Installationsset Strahler Dreiphasenschiene Kit installazione proiettore per binario trifase	14 - 14 ○ 71-6481 - EU ○ 60 - 60 ● EU ●
	Klammern x 20 Clips x 20	71-6607 - 00 - 00 ○
	2 m starr Profil Profilo 2m rigido	71-6608 - 00 - 00 ○
	Zubehör für Installation an der Wand Accessorio per installazione parete	60 ● 71-7518 - 14 - 00 ○ N3 ●
	Installationsset ohne Rahmen Kit installazione senza cornice	71-7522 - 14 - 00 ○
	Installationsset ohne Rahmen Kit installazione senza cornice	71-7523 - 14 - 00 ○
	Visueller Komfort Schwarz Comfort visivo Nero	71-7524 - 60 - 00 ●
	Stahlkabel + Abhängklammer Weiß Cavo d'acciaio + clip sospensione bianco	71-7656 - 14 - 00 ○ 60 - 00 ●





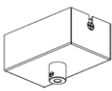







Zubehör / Accessori

	2 m flexibles Profil Profilo 2m flessibile	71-7698 - 00 - 00	<input type="radio"/>
	Sensor DALI D4i Connected Sensore DALI D4i Connected	71-7735 - 60 - SE	<input checked="" type="radio"/>
		N3	<input type="radio"/>
	Sensor Up&Down DALI D4i Connected Sensore Up&Down DALI D4i Connected	71-7736 - 14 - SE	<input type="radio"/>
		60	<input checked="" type="radio"/>
	Installation mit verborgenem/halbverborgenem Profil Installazione in profilo nascosto/seminascosto	71-7841 - 00 - 00	<input type="radio"/>
	Schirm x 5 Screen x 5	71-7894 - 60 - 00	<input checked="" type="radio"/>
		71-7895	<input type="radio"/>
	Starter x 5u Starter x 5u	71-8092 - 00 - 00	<input type="radio"/>
	Junction x 5u Junction x 5u	71-8093 - 00 - 00	<input type="radio"/>
	Starter x 5u Starter x 5u	71-8094 - 00 - 00	<input type="radio"/>
	Junction x 5u Junction x 5u	71-8095 - 00 - 00	<input type="radio"/>
	Starter RGB x 5u Starter RGB x 5u	71-8096 - 00 - 00	<input type="radio"/>
	Junction RGB x 5u Junction RGB x 5u	71-8097 - 00 - 00	<input type="radio"/>
	Starter RGB x 5u Starter RGB x 5u	71-8098 - 00 - 00	<input type="radio"/>
	Junction RGB x 5u Junction RGB x 5u	71-8099 - 00 - 00	<input type="radio"/>
	Starter x 5u Starter x 5u	71-8100 - 00 - 00	<input type="radio"/>
	Junction x 5u Junction x 5u	71-8101 - 00 - 00	<input type="radio"/>
	90°-Verbindungsstück Unterputz Rahmen Unione 90° incasso cornice	71-8112 - 14 - 00	<input type="radio"/>
		DA	<input type="radio"/>















Zubehör / Accessori

	90°-Verbindungsstück Unione 90°	14 71-8113 - N3 - 60	00 DA	<input type="radio"/> <input type="radio"/> <input type="radio"/>
	90°-Verbindungsstück Up&Down Unione 90° Up&Down	14 71-8114 - N3 - 60	00 DA	<input type="radio"/> <input type="radio"/> <input type="radio"/>
	Warmer Filter Filtro caldo	71-8227 - 00 - 00		<input type="radio"/>
	Neutraler Filter Filtro neutro	71-8228 - 00 - 00		<input type="radio"/>
	DALI Verbindungsset Kit unione DALI	71-8246 - 00 - DA		<input type="radio"/>
	IP68-Stecker mit 6 Eingängen Connettore IP68 a 6 ingressi	71-9199 - 05 - 05		<input type="radio"/>
	IP67-Stecker mit 3 Eingängen Connettore IP67 a 3 ingressi	71-9262 - 05 - 05		<input type="radio"/>
	Befestigungssystem auf Pergolen für bis zu 3 Strahler Ancoraggio per pergolati fino a 3 proiettori	71-9746 - 05 - 05		<input type="radio"/>
	Bodenbefestigungsbolzen Bulloni di fissaggio al suolo	71-9955 71-E092 - 48 - 48 71-E164		<input type="radio"/>
	Bodenbefestigungsbolzen Bulloni di fissaggio al suolo	71-9957 71-E002 71-E008 - 48 - 48 71-E009 71-E031 71-E213		<input type="radio"/>
	Pflock 235 mm Paletto 235mm	71-9997 - 05 - 05		<input type="radio"/>
	Pflock 302mm Paletto 302mm	71-9998 - 05 - 05		<input type="radio"/>
	Befestigungszubehör zur Montage am Mast oder Baum Fissaggio per colonne o alberi	71-9999 - Z5 - Z5		<input type="radio"/>
	Betriebsgerät für Infinite Pro Emergency Alimentatore per Infinite Pro Emergency	60 71-A223 - 14 - 00 N3	<input type="radio"/> <input type="radio"/>	<input type="radio"/>
	Betriebsgerät DALI für Infinite Pro Emergency Alimentatore DALI per Infinite Pro Emergency	14 71-A228 - 60 - 00 N3	<input type="radio"/> <input type="radio"/>	<input type="radio"/>





































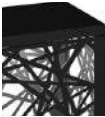

Zubehör / Accessori

	Sensor DALI D4i One Sensore DALI D4i One	14 71-A263 - 60 - SE N3	<input type="radio"/> <input checked="" type="radio"/> <input type="radio"/>
	Sensor Up&Down DALI D4i One Sensore Up&Down DALI D4i One	14 71-A264 - 60 - SE N3	<input type="radio"/> <input checked="" type="radio"/> <input type="radio"/>
	Abschlussabdeckung für Low-Voltage-Schiene Tappo di chiusura per binario Low Voltage	71-A334 - 00 - 00	<input type="radio"/>
	1-m-Kabel mit wasserdichten Schnellsteckverbindern Cavo da 1m con connettori rapidi a tenuta stagna	71-E000 71-E001 - 00 - 00 71-E034	<input type="radio"/>
	5-m-Kabel mit wasserdichten Schnellsteckverbindern Cavo da 5m con connettori rapidi a tenuta stagna	71-E004 71-E110 - 00 - 00 71-E111 71-E118	<input type="radio"/>
	5-m-Kabel mit wasserdichten Schnellsteckverbindern RGB Cavo da 5m con connettori rapidi a tenuta stagna RGB	71-E005 - 00 - 00	<input type="radio"/>
	Bodenbefestigungsbolzen Bulloni di fissaggio al suolo	71-E006 71-E012 71-E013 - 48 - 48 71-E018 71-E028 71-E029	<input type="radio"/>
	Sockel für Kabel von Ø 6 mm bis Ø 13,5 mm Base per cavi da Ø6mm a Ø13,5mm	71-E016 - Z5 - Z5	<input checked="" type="radio"/>
	Bodenbefestigungsbolzen Bulloni di fissaggio al suolo	71-E030 - 48 - 48 71-E363	<input type="radio"/>
	Unterputzdose Scatola da incasso	71-E035 71-E036 71-E104 71-E105 - 00 - 00 71-E354 71-E355 71-E356	<input type="radio"/>
	Aufbausatz mit ON-OFF-Treiber Kit da superficie con driver ON-OFF	71-E039 - 05 - 05 71-E364	<input checked="" type="radio"/>
	Aufbausatz mit DALI-Treiber Kit da superficie con driver DALI	71-E041 - 05 - 05	<input checked="" type="radio"/>
	Verlängerungskabel mit 300 + 500 mm Länge für Wand, Boden und Rasen Picchetto a parete misura 300+500mm	34 - 34 71-E052 - J6 - J6 Z5 - Z5	<input type="radio"/> <input checked="" type="radio"/> <input checked="" type="radio"/>











Zubehör / Accessori

	Unterputzdose Scatola da incasso	71-E065 - 60 - 00 ●
	1-m-Kabel mit wasserdichten Schnellsteckverbindern RGB Cavo da 1m con connettori rapidi a tenuta stagna RGB	71-E071 - 00 - 00 ○
	Lupe für engen Strahl Lente per fascio di luce stretto	71-E078 - Z5 - 00 ●
	Unterputzdose Scatola da incasso	71-E090 - Z5 - 00 ●
	Unterputzdose Scatola da incasso	71-E093 - 05 - 05 ● 71-E095
	IP66 IK9-konformes Gehäuse zur Geräteinstallation Scatola IP66 IK9 per installazione di apparecchiature	71-E100 - 00 - 00 ○
	IP68- Antikondensationsstecker mit 2 Eingängen Connettore IP68 con valvola anticondensa a 2 ingressi	71-E112 - 00 - 00 ○
	Kratzfester Lack in Z5-Grau Vernice antigraffio in grigio Z5	71-E117 - Z5 - 00 ●
	IP68- Antikondensationsstecker mit 4 Eingängen Connettore IP68 con valvola anticondensa a 4 ingressi	71-E122 - 00 - 00 ○
	5 Lichtfilter für gestreute Lichtkegel 5 filtri per l'emissione di luce diffusa	71-E133 - 00 - 00 ○
	5 Lichtfilter für quadratische Lichtkegel 5 filtri per l'emissione di luce quadrata	71-E135 71-E260 - 00 - 00 ○ 71-E262
	Unterputzdose Scatola da incasso	71-E139 - 00 - 00 ○
	5 Lichtfilter für elliptische Lichtkegel 5 filtri per emettere luce ellittica	71-E141 - 00 - 00 ○ 71-E261
	Erdbefestigungsspieß Picchetto di fissaggio a terra	71-E143 - 05 - 05 ●
	Blende Visiera	71-E145 - 25 - 25 ● 71-E145 - 14 - 14 ○ 71-E145 - 34 - 34 ● 71-E259 - 60 - 60 ● 71-E259 - DL - DL ● 71-E259 - E3 - E3 ● 71-E259 - J6 - J6 ●

Zubehör / Accessori

	Befestigungsarme, Länge 307 mm Bracci fissi, di 307mm di lunghezza	71-E155 - CA - CA	
	Bodenbefestigungsschrauben Bulloni di fissaggio a pavimento	71-E157 - 00 - 00	
	Asymmetrischer Lichtstrahlfilter Filtro per fascio di luce asimmetrico	71-E200 - 00 - 00	
	Erdeinbausatz mit ON-OFF-Treiber Kit per interrare con driver ON-OFF	71-E225 - 05 - 05 71-E226	
	Soul-Zubehör Accessorio Soul	71-E227 - 00 - 00	
	Blende Visiera	71-E234 - 60 - 00	 Z5  14  34  DL  E3  J6
	Verkettungszubehör Leuchtenkopf extra Accessorio extra di collegamento in serie	71-E235 - 60 - 00	 Z5  14  34  DL  E3  J6
	Unterputzdose Scatola da incasso	71-E264 - 00 - 00	
	Satz 4 x Zierabdeckungen Set 4 x coperchi decorativi	71-E278 71-E279 71-E280 71-E281 - 60 - 00 71-E282 71-E294	 Z5  14  34  DL  E3  J6
	Kugeldiffusor aus Opalglas Diffusore sferico di vetro opal	71-E284 - 60 - F9	
	Rollen Ruote	71-E292 - 60 - 00	
	Zugentlastungssatz wiederaufladbare Leuchte Kit anti-tiro per lampada ricaricabile	71-E293 - 00 - 00	

Zubehör / Accessori

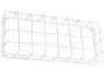





















	Befestigungssystem für Rasen 15 x 15 mm Sistema di fissaggio per prato 15x15mm	71-E357 - 60 - 00 ○ 71-E358
	Verlängerungsarm 70mm Tiefe. Braccio dilatatore da 70 mm di profondità.	Z5 ● 14 ○ 34 ● 71-E359 - 60 - 00 ● DL ● E3 ● J6 ●
	Verlängerungsarm 140mm Tiefe. Braccio dilatatore da 140 mm di profondità.	Z5 ● 14 ○ 34 ● 71-E360 - 60 - 00 ● DL ● E3 ● J6 ●
	IP67-Stecker mit 5 Eingängen Connettore IP68 5 ingressi	71-E361 - 00 - 00 ○
	Ausbausatz für das LED-Modul bei Defekt. Kit di estrazione del modulo LED in caso di guasto.	71-E362 - Z5 - 00 ● 71-E366
	Einzelladegerät Caricatore singolo	71-E367 - 60 - 00 ●
	Schienenset mit Rahmen Kit tracks con cornice	ACT-9165 - 48 - 00 ○
	Bulb AR Led Bulb AR Led	015 ACT-FLL - 017 032 033
	Bulb QPAR16 Led Bulb QPAR16 Led	024 025 ACT-FLL - 026 027 028 029
	Einbauzubehör DECO Accessorio da incasso DECO	EM01-0001
	Wandeinbauzubehör Deco Accessorio da incasso a parete Deco	EM01-0002
	Zubehör Deco Anti-Vandalismus Accessori Deco anti vandalismo	EM01-0003























Zubehör / Accessori

	Piktogramm Pfeil nach rechts Pittogramma freccia a destra	EM01-0005
	Piktogramm Pfeil nach links Pittogramma freccia a sinistra	EM01-0006
	Piktogramm Pfeil nach oben Pittogramma freccia in alto	EM01-0007
	Piktogramm Pfeil nach unten Pittogramma freccia in basso	EM01-0008
	Zubehör Signalisierung Deco Accessori Segnaletica Deco	EM02-0004
	Durchmesseradapter Weiß Redo Adattatore di diametro Bianco Redo	EM04-0001
	Durchmesseradapter Schwarz Redo Adattatore di diametro Nero Redo	EM04-0003























Extra Reader's Guide

Symbole / Simbologia

	Neuheit	Novità
	Strukturmaterial	Materiale della struttura
	Diffusormaterial	Materiale del diffusore
	Klasse I	Classe I
	Klasse II	Classe II
	Klasse III	Classe III
	Die Sicherheitsschicht ist eine Folie, die auf die Rückseite des Spiegels aufgetragen wird, um Verletzungen durch Glas im Falle eines Bruchs zu verhindern.	Il supporto di sicurezza è una pellicola applicata sul retro degli specchi per evitare lesioni da vetro in caso di rottura.
	Sensor	Sensore
	Flügelmaterial	Materiale delle pale
	Betriebsstunden	Ore di vita
	MacAdam	MacAdam
	UGR	UGR
	Low Flicker	Low Flicker
	Dieses Codierungssystem dient zur Angabe des Schutzgrades eines Gehäuses zum Schutz gegen das Eindringen fester Gegenstände, Staub oder Flüssigkeiten.	Sistema di codificazione per indicare il grado di protezione fornito da un involucro contro la penetrazione di oggetti solidi, di polvere o di liquidi
	Dieses Codierungssystem dient zur Angabe des Schutzgrades eines Gehäuses zum Schutz gegen schädliche mechanische Stöße. Schlagenergie (Joule)	Sistema di codificazione per indicare il grado di protezione fornito da un rivestimento contro gli impatti meccanici dannosi. Energia di impatto (Joule)
	Leuchte nicht geeignet zur Abdeckung mit Wärmeisoliermaterial	Apparecchi non adatti ad essere coperti con materiale isolante termico
	Montage auf normal entflammaren Oberflächen nicht zulässig	Apparecchi non adatti ad essere montati su superfici infiammabili
	ACHTUNG - Diese Leuchte ist bis zum angegebenen Gewicht belastbar. Geeignet für Bereiche in denen Fahrzeuge mit niedriger Geschwindigkeit fahren. NICHT GEEIGNET für stark frequentierte Bereiche.	ATTENZIONE-Questo apparecchio è in grado di sopportare un carico statico limitato. È ADATTO per le aree stradali con traffico a bassa velocità. NON È ADATTO per aree stradali con traffico a velocità media
	Max. Länge in Metern bei Reihenanschluss	N. massimo di metri di connessione in serie
	x Meter langes Kabel	x metri di cavo
	Zwei Kabelausgänge	Cavo a doppia uscita
	5-fach Vergrößerungsspiegel	Lente d'ingrandimento x5

	3-fach Vergrößerungsspiegel	Lente d'ingrandimento x3
	Antifog. Eingebautes System zur Verhinderung des Beschlagens des Spiegels durch Wasserdampf.	Antifog. Sistema incluso per evitare che lo specchio si appanni con il vapore acqueo.
	Gerät nicht mitgeliefert	Dispositivo non incluso
	Gerät mitgeliefert	Dispositivo incluso
	Die Federn ermöglichen eine Installation an Decken von X mm bis X mm	I fissaggi consentono l'installazione dell'articolo su soffitti da X mm a X mm
	Mit der Umkehrfunktion drehen sich die Flügel in die entgegengesetzte Richtung. In den kalten Monaten wird so die warme Luft von der Decke zum Boden bewegt und somit der Raum in Kombination mit dem Heizsystem energiesparend beheizt.	La funzione inversa fa girare le pale in senso contrario. Nei mesi freddi, consente di spostare l'aria calda dal soffitto a terra e di riscaldare l'ambiente risparmiando energia quando lo si usa come sistema di riscaldamento.
	Lüftungsgeschwindigkeit, Motordrehzahl.	Velocità di ventilazione, velocità di rotazione del motore.
	Entspricht der für die Erlangung des BREEAM-Zertifikats für nachhaltiges Bauen erforderlichen Beleuchtungseffizienz, berechnet durch Division der tatsächlichen Lumen durch die Gesamtleistung der Leuchte.	Rispetta l'efficienza luminica richiesta per ottenere la certificazione di costruzione sostenibile BREEAM, calcolata dividendo i lumen reali per la potenza totale dell'apparecchio.
	WELL. Trägt zur Erfüllung von Merkmal L06 des WELL-Buidling Standard® bei.	WELL. Contribuisce a soddisfare il requisito L06 del WELL Building Standard®.
	USB-Anschluss	Connessione USB
	Einbaudurchmesser	Diametro di incasso
	Einbauabmessungen	Foro di incasso
	Verstellbar	Orientabile
	Verstellbar	Orientabile
	Verstellbar	Orientabile
	Verstellbar	Orientabile
	Verstellbar	Orientabile
	Verstellbar	Orientabile
	Verstellbar	Orientabile
	Verstellbar	Orientabile
	Dimmsystem	Sistema di regolazione
	Dimmsystem	Sistema di regolazione
	Dimmsystem	Sistema di regolazione



























Symbole / Simbologia

	Dimmsystem	Sistema di regolazione
	Dimmsystem	Sistema di regolazione
	Dimmsystem	Sistema di regolazione
	Dimmsystem	Sistema di regolazione
	Dimmsystem	Sistema di regolazione
	Dimmsystem	Sistema di regolazione
	Dimmsystem	Sistema di regolazione
	Dimmsystem	Sistema di regolazione
	Dimmsystem	Sistema di regolazione
	Zur Installation in Meeresnähe geeignete Leuchte.	Apparecchi adatti per essere installati in ambienti marini
	Drainage. Siehe Installationsempfehlungen auf Seite XXX	Drenaggio. Vedere Raccomandazioni per l'installazione pag. XXX
	Mit einem von LEDS C4 entwickelten Bodenbefestigungssystem, das die Robustheit und Langlebigkeit der Leuchten gewährleistet und dafür sorgt, dass es auch bei unebenem Boden keine Neigungsunterschiede zwischen den Leuchten gibt.	Include il sistema di fissaggio a terra sviluppato da LEDS C4, che assicura la solidità e la durata di vita degli apparecchi e fa in modo che non presentino differenze di inclinazione anche in caso di terreno irregolare.
	Variation der Farbtemperatur von warm bis kalt	Variazione della temperatura di colore, da calda a fredda
	Schalter	Commutatore di accensione
	Doppelschalter	Doppio interruttore di accensione
	Fernbedienung	Telecomando
	Leuchten mit integrierter Konnektivität.	Luci con connettività integrata.
	Leuchten, die mit Hilfe von Zubehör konnektiv gemacht werden können.	Luci che possono essere collegate tramite un accessorio dedicato.
	Die Leuchte ist überrollbar gemäß EN 60598-2-13 (Torsionsfestigkeits- und Scherbelastungstests).	Apparecchio adatto al passaggio dei veicoli ai sensi della normativa EN 60598-2-13 (prove di resistenza alla torsione e al taglio sotto carico).
	Airflow (CFM). Maßeinheit für den Luftstrom vom Ventilator (Kubikfuß pro Minute).	Airflow (CFM). Unità di misurazione del flusso d'aria del ventilatore (metri cubi al minuto)
	DC Motor. Gleichstrommotor mit besserer Effizienz und besserem Verbrauch.	DC Motors. Motore a corrente continua. Migliore efficienza e consumo.
	Mit Lichtquelle	Include sorgente di luce.
	Dimmsystem	Sistema di regolazione



























Materials / Materiali

ABS	ABS	ABS
ACR	Acryl	Acrilico
AISI304	Edelstahl AISI 304	Acciaio inossidabile AISI 304
AISI316	Edelstahl AISI 316	Acciaio inossidabile AISI 316
AL	Aluminium	Alluminio
ALAB	Alabaster	Alabastro
CON	Zement	Cemento
FELT	Filz	Feltri
G	Graphen	Grafene
GL TMP	Gehärtetes Glas	Vetro temprato
GLA	Glas	Vetro
MA	Metacrylat	Metacrilato
MIR	Spiegel	Specchio
NPRN	Neopren	Neoprene
PA	Nylon	Nylon
PC	Polykarbonat	Policarbonato
PC+ABS	Polykarbonat + ABS	Policarbonato + ABS
PE	Polyethylen	Polietilene
PL ABS	Kunststoff	Plastica
PLSTER	Gips	Gesso
PLY	PLY	PLY
PMMA	PMMA	PMMA
POLI	Technopolymer	Tecnopolimero
PP	Polypropylen	Polipropilene
PUR	Polyurethan	Poliuretano
PVC	PVC	PVC
R	Harz	Resina
RATAN	Rattan	Rattan
SIL	Silikon	Silicone
ST	Stahl	Acciaio
TEX	Textil	Tessile
VYL	Vinyl	Vinil
WOOD	Holz	Legno

















Ausführungen / Finiture

	ES	Natur-Rattan	Rattan naturale
	ET	Goldfarben lackiert	Oro verniciato
	F1	Sandgestrahltes Glas	Vetro sabbiato
	WG	Weiß/Gold	Bianco/Oro
	WH	Schwarz/Weiß	Nero/Bianco
	WI	Gold/Weiß	Oro/Bianco
	WJ	Gold/Gold	Oro/Oro
	WK	Gold/Schwarz	Oro/Nero
	WL	Schwarz/Weiß	Nero/Bianco
	WM	Schwarz/Gold	Nero/Oro
	WN	Schwarz/Schwarz	Nero/Nero
	WP	Trimless/Weiß	Trimless/Bianco
	WQ	Trimless/Schwarz	Trimless/Nero
	WR	Weiß/Weiß	Bianco/bianco
	WS	Trimless/Gold	Trimless/Oro
	WT	Trimless/Weiß	Trimless/Bianco
	K3	Spiegelglas	Vetro a specchio
	M1	Opalweiß	Bianco opalino
	00	Weiß	Bianco
	14	Weiß	Bianco
	21	Chrom	Cromo
	34	Grau	Grigio
	Z5	Anthrazit	Grigio urbano
	60	Schwarz	Nero
	81	Nickel seidenmatt	Nichel satinato
	M3	Eloxiert	Anodizzato

Ausführungen / Finiture

	03	Silber	Argento
	20	Beige	Beige
	01	Gold	Oro
	CV	Mehrfarbig	Multicolore
	37	Durchsichtig	Trasparente
	11	Blau	Blu
	19	Bronze	Bronzo
	DC	Zement	Cemento
	24	Gelb	Giallo
	S2	Aluminium seidenmatt	Alluminio satinato
	13	Rosa	Rosa
	E0	Eichenholz	Rovere
	55	Alabaster	Alabastro
	DN	Mattgold	Oro opaco
	05	Metallic schwarz	Nero metallico
	DO	Poliertes Messing	Ottone lucido
	EP	Intensiv golden	Oro intenso
	23	Gold	Oro
	DL	Gold	Oro
	AF	Aluminium seidenmatt	Alluminio satinato
	EN	Nussholz	Noce
	N3	Grau	Grigio
	54	Eloxiertes Aluminium	Alluminio anodizzato
	J6	Braun	Marrone
	EM	Steingrau	Grigio pietra
	F5	Gold	Oro

Ausführungen / Finiture

	CS	Zementgrau	Grigio cemento
	93	Helles Holz	Legno chiaro
	CI	Braun	Marrone
	E4	Edelrost	Patinato
	16	Alt Weiß	Bianco antico
	BY	Sandfarbe	Sabbia
	CA	AISI316-Edelstahl	Acciaio inossidabile AISI 316
	48	Verzinkter Stahl	Acciaio zincato
	CF	Weiß glänzend	Bianco lucido
	DB	Metallic-Grau	Grigio metallizzato
	J7	Kupferrot-Braun	Marrone ramato
	S4	Goldener Bernstein	Ambra dorata
	45	Mattschwarz Eloxiert	Nero opaco anodizzato
	50	Edelrost	Patinato
	GA	Filz hellgrau	Feltro grigio chiaro
	GB	Filz dunkelgrau	Feltro grigio scuro
	E3	Birkengrün	Verde abete

Images references



Fuego Camina Conmigo
Architecture: Isern Serra
Year: 2021
Location: Barcelona, Spain
Photography: Enric Badrinas



Fuego Camina Conmigo
Architecture: Isern Serra
Year: 2021
Location: Barcelona, Spain
Photography: Enric Badrinas / Alga Studio



Six N. Five
Architecture: Isern Serra
Year: 2021
Location: Barcelona, Spain
Photography: Enric Badrinas



Six N. Five
Architecture: Isern Serra
Year: 2021
Location: Barcelona, Spain
Photography: Enric Badrinas / Alga Studio



Festival Grec
Lighting Design: LEDES C4
Year: 2021
Location: Barcelona, Spain
Photography: Jordi Anguera



Loom, Torre Glòries
Architecture: Studio Banana
Lighting Design: LEDES C4
Year: 2019
Location: Barcelona, Spain
Photography: Jordi Anguera



Escola Industrial
Lighting Design: LEDES C4
Year: 2020
Location: Barcelona, Spain



Sede Verdissimo
Architecture: Perretta Arquitectura
Lighting Design: Stucco Llums
Year: 2017
Location: Paterna, Valencia, Spain



Station 2000 Residence
Year: 2020
Location: Malmo, Sweden



Manusa Offices
Lighting Design: LEDES C4
Year: 2020
Location: Polinyà, Barcelona, Spain
Photography: Enric Badrinas



D House
Architecture: DFG Architetti
Year: 2020
Location: Vittoria, Sicilia, Italia
Photography: Marcello Bocchieri



Campus Bahía de Algeciras, Cádiz University
Architecture: 000A Arquitectos
Year: 2017
Location: Cádiz, Spain



Two at Symphony
Lighting Design: Light.Func
Year: 2018
Location: Dubai, UAE



Radisson Blu Hotel
Interior Design: Demuth + Béné-Combes
Year: 2017
Location: Lyon, France
Photography: Vicent Ramet



Les Cols Restaurant
Year: 2020
Location: Olot, Gerona, Spain
Photography: Fotodisseny



Son Rich Residences
Architecture: OBREIN Arquitectura y Gestión
Year: 2018
Location: Begur, Gerona, Spain



Mediterranean Luxury Villas
Year: 2017
Location: Finestrat, Valencia, Spain



Private house
Interior Design: Giró Interiors
Year: 2021
Location: Gerona, Spain



Alle Rechte vorbehalten. Ohne vorherige Zustimmung des Herausgebers oder der Rechteinhaber darf kein Teil dieses Buchs auf Papier oder digital vervielfältigt werden. Tutti i diritti riservati. Nessuna parte di questo documento può essere riprodotta in nessun formato cartaceo o elettronico, senza il previo consenso dell'editore o dei proprietari del copyright.

Verzeichnis (Artikelnummer sortiert) / Indice di referenze

Referenz Codice	Seite Pag.	Referenz Codice	Seite Pag.	Referenz Codice	Seite Pag.	Referenz Codice	Seite Pag.
00-4941-XX-XX	301	05-9885-XX-XX	633	05-E062-XX-XX	478, 568, 808,836	10-E017-XX-XX	868
00-4944-XX-XX	301	05-9886-XX-XX	827	05-E063-XX-XX	836	10-E055-XX-XX	705
00-4947-XX-XX	301	05-9889-XX-XX	592	05-E064-XX-XX	837	10-E077-XX-XX	795
00-4950-XX-XX	301	05-9894-XX-XX	820	05-E068-XX-XX	767	15-5922-XX-XX	274
00-4953-XX-XX	301	05-9911-XX-XX	781	05-E071-XX-XX	867	15-5923-XX-XX	274
00-4962-XX-XX	301	05-9912-XX-XX	780	05-E076-XX-XX	867	15-5924-XX-XX	274
00-5922-XX-XX	302	05-9919-XX-XX	782	05-E077-XX-XX	867	15-5925-XX-XX	274
00-5923-XX-XX	302	05-9926-XX-XX	790	05-E078-XX-XX	785	15-5926-XX-XX	277
00-5924-XX-XX	302	05-9952-XX-XX	770	05-E079-XX-XX	784	15-5927-XX-XX	277
00-5925-XX-XX	302	05-9953-XX-XX	771	05-E080-XX-XX	785	15-5928-XX-XX	277
00-5926-XX-XX	303	05-9954-XX-XX	770	05-E081-XX-XX	784	15-5929-XX-XX	277
00-5927-XX-XX	303	05-9955-XX-XX	771	05-E082-XX-XX	879	15-5946-XX-XX	243
00-5928-XX-XX	303	05-9956-XX-XX	770	05-E083-XX-XX	558	15-6282-XX-XX	98
00-5929-XX-XX	303	05-9957-XX-XX	771	05-E084-XX-XX	780	15-6283-XX-XX	98
00-7341-XX-XX	138	05-9959-XX-XX	556	05-E086-XX-XX	780	15-6284-XX-XX	98
00-7342-XX-XX	138	05-9960-XX-XX	557	05-E087-XX-XX	799	15-6485-XX-XX	97
00-7592-XX-XX	140	05-9971-XX-XX	821	05-E088-XX-XX	879	15-6486-XX-XX	97
00-7593-XX-XX	140	05-9988-XX-XX	585	05-E089-XX-XX	879	15-6487-XX-XX	97
00-7906-XX-XX	139	05-9989-XX-XX	555	05-E090-XX-XX	801	15-7098-XX-XX	264
00-7907-XX-XX	139	05-9993-XX-XX	830	05-E091-XX-XX	801	15-7099-XX-XX	264
00-9155-XX-XX	884	05-E000-XX-XX	524	05-E093-XX-XX	535	15-7100-XX-XX	264
00-9156-XX-XX	884	05-E001-XX-XX	524	05-E094-XX-XX	535	15-7101-XX-XX	264
05-1804-XX-XX	341	05-E002-XX-XX	525	05-E095-XX-XX	535	15-7161-XX-XX	264
05-2904-XX-XX	341	05-E003-XX-XX	525	05-E096-XX-XX	535	15-7169-XX-XX	264
05-6399-XX-XX	313	05-E007-XX-XX	576	05-E100-XX-XX	520	15-7184-XX-XX	264
05-6405-XX-XX	313	05-E008-XX-XX	576	05-E102-XX-XX	827	15-7185-XX-XX	264
05-6408-XX-XX	313	05-E009-XX-XX	576	05-E106-XX-XX	813	15-7186-XX-XX	264
05-6411-XX-XX	313	05-E010-XX-XX	576	05-E107-XX-XX	813	15-7187-XX-XX	264
05-8764-XX-XX	782	05-E011-XX-XX	577	05-E109-XX-XX	817	15-7188-XX-XX	264
05-8765-XX-XX	782	05-E012-XX-XX	805	05-E146-XX-XX	619	15-7189-XX-XX	264
05-8766-XX-XX	782	05-E013-XX-XX	577	05-E147-XX-XX	619	15-7190-XX-XX	264
05-8767-XX-XX	782	05-E014-XX-XX	617	05-E152-XX-XX	576	15-7191-XX-XX	264
05-9177-XX-XX	787	05-E015-XX-XX	616	05-E153-XX-XX	576	15-7192-XX-XX	264
05-9245-XX-XX	592	05-E016-XX-XX	615	05-E154-XX-XX	577	15-7193-XX-XX	264
05-9310-XX-XX	586	05-E017-XX-XX	615	10-9386-XX-XX	726	15-7194-XX-XX	264
05-9416-XX-XX	559	05-E020-XX-XX	780	10-9387-XX-XX	726	15-7195-XX-XX	264
05-9444-XX-XX	821	05-E021-XX-XX	781	10-9733-XX-XX	737	15-7196-XX-XX	265
05-9640-XX-XX	587	05-E024-XX-XX	633	10-9791-XX-XX	716	15-7197-XX-XX	265
05-9649-XX-XX	787	05-E025-XX-XX	634	10-9847-XX-XX	701	15-7198-XX-XX	265
05-9679-XX-XX	790	05-E026-XX-XX	787	10-9903-XX-XX	795	15-7199-XX-XX	265
05-9683-XX-XX	789	05-E027-XX-XX	787	10-9938-XX-XX	725	15-7200-XX-XX	265
05-9684-XX-XX	789	05-E028-XX-XX	817	10-9994-XX-XX	701	15-7201-XX-XX	265
05-9685-XX-XX	791	05-E031-XX-XX	635	10-E001-XX-XX	866	15-7202-XX-XX	265
05-9722-XX-XX	559	05-E046-XX-XX	589	10-E002-XX-XX	866	15-7203-XX-XX	265
05-9749-XX-XX	520	05-E047-XX-XX	780	10-E003-XX-XX	866	15-7204-XX-XX	265
05-9750-XX-XX	520	05-E048-XX-XX	781	10-E004-XX-XX	870	15-7305-XX-XX	99
05-9757-XX-XX	635	05-E049-XX-XX	633	10-E005-XX-XX	870	15-7306-XX-XX	99
05-9758-XX-XX	634	05-E050-XX-XX	634	10-E006-XX-XX	870	15-7307-XX-XX	99
05-9773-XX-XX	783	05-E051-XX-XX	633	10-E007-XX-XX	868	15-7308-XX-XX	99
05-9779-XX-XX	804	05-E052-XX-XX	780	10-E008-XX-XX	868	15-7309-XX-XX	99
05-9789-XX-XX	588	05-E054-XX-XX	782	10-E009-XX-XX	868	15-7310-XX-XX	99
05-9802-XX-XX	804	05-E055-XX-XX	817	10-E010-XX-XX	870	15-7806-XX-XX	275
05-9814-XX-XX	805	05-E056-XX-XX	783	10-E011-XX-XX	870	15-7807-XX-XX	275
05-9832-XX-XX	634	05-E057-XX-XX	589	10-E012-XX-XX	870	15-7808-XX-XX	275
05-9873-XX-XX	820	05-E058-XX-XX	767	10-E013-XX-XX	740	15-7809-XX-XX	275
05-9878-XX-XX	781	05-E059-XX-XX	767	10-E014-XX-XX	868	15-7810-XX-XX	275
05-9879-XX-XX	780	05-E060-XX-XX	581	10-E015-XX-XX	868	15-7811-XX-XX	275
05-9881-XX-XX	585	05-E061-XX-XX	581	10-E016-XX-XX	715	15-7842-XX-XX	274
05-9884-XX-XX	830					15-7843-XX-XX	274

Verzeichnis (Artikelnummer sortiert) / Indice di referenze

Referenz Codice	Seite Pag.	Referenz Codice	Seite Pag.	Referenz Codice	Seite Pag.	Referenz Codice	Seite Pag.
15-7885-XX-XX	267	25-E006-XX-XX	872	35-A019-XX-XX	87	55-9667-XX-XX	658
15-7886-XX-XX	267	25-E007-XX-XX	872	35-A020-XX-XX	87	55-9682-XX-XX	735
15-7888-XX-XX	267	25-E008-XX-XX	872	35-A021-XX-XX	85	55-9721-XX-XX	734
15-7889-XX-XX	267	25-E009-XX-XX	872	35-A022-XX-XX	85	55-9723-XX-XX	659
15-9480-XX-XX	854	25-E010-XX-XX	872	35-A023-XX-XX	85	55-9733-XX-XX	737
15-9619-XX-XX	855	25-E011-XX-XX	872	35-A051-XX-XX	87	55-9741-XX-XX	687
15-9708-XX-XX	609	25-E012-XX-XX	874	35-A052-XX-XX	87	55-9768-XX-XX	660
15-9790-XX-XX	848	25-E013-XX-XX	874	35-A053-XX-XX	87	55-9769-XX-XX	660
15-9806-XX-XX	855	25-E014-XX-XX	874	35-A054-XX-XX	109	55-9791-XX-XX	716
15-9835-XX-XX	828	25-E015-XX-XX	876	35-A055-XX-XX	109	55-9792-XX-XX	593
15-9904-XX-XX	849	35-6276-XX-XX	84	35-A056-XX-XX	109	55-9822-XX-XX	657
15-9948-XX-XX	608	35-6277-XX-XX	84	35-A057-XX-XX	109	55-9823-XX-XX	657
15-A003-XX-XX	315, 915	35-6278-XX-XX	84	35-A058-XX-XX	109	55-9824-XX-XX	658
15-A018-XX-XX	99	35-6282-XX-XX	86	35-A059-XX-XX	109	55-9825-XX-XX	658
15-A019-XX-XX	99	35-6283-XX-XX	86	35-A060-XX-XX	85	55-9873-XX-XX	732
15-A020-XX-XX	99	35-6284-XX-XX	86	35-A061-XX-XX	85	55-9880-XX-XX	887
15-A024-XX-XX	99	35-6288-XX-XX	88	35-A062-XX-XX	85	55-9883-XX-XX	687
15-A025-XX-XX	99	35-6289-XX-XX	88	35-A063-XX-XX	91	55-9890-XX-XX	717
15-A026-XX-XX	99	35-6290-XX-XX	88	35-A064-XX-XX	91	55-9906-XX-XX	654
15-A041-XX-XX	267	35-7279-XX-XX	91	35-A066-XX-XX	85	55-9907-XX-XX	654
15-A042-XX-XX	267	35-7280-XX-XX	91	35-A067-XX-XX	85	55-9908-XX-XX	656
15-A043-XX-XX	267	35-7281-XX-XX	91	35-A068-XX-XX	85	55-9909-XX-XX	655
15-A044-XX-XX	267	35-7282-XX-XX	91, 133	35-A072-XX-XX	91, 133	55-9910-XX-XX	656
15-E000-XX-XX	852	35-7283-XX-XX	91, 133	35-A073-XX-XX	91, 133	55-9921-XX-XX	735
15-E001-XX-XX	852	35-7284-XX-XX	91, 133	35-A075-XX-XX	85, 87, 89	55-9938-XX-XX	725
15-E002-XX-XX	852	35-7285-XX-XX	90, 132	35-A076-XX-XX	119	55-9939-XX-XX	725
15-E003-XX-XX	852	35-7286-XX-XX	90, 132	35-A077-XX-XX	89	55-9944-XX-XX	734
15-E004-XX-XX	852	35-7287-XX-XX	85	35-A078-XX-XX	89	55-9945-XX-XX	689
15-E005-XX-XX	852	35-7288-XX-XX	85	35-A079-XX-XX	89	55-9946-XX-XX	689
15-E006-XX-XX	853	35-7289-XX-XX	85	55-1573-XX-XX	342	55-9947-XX-XX	689
15-E007-XX-XX	853	35-7290-XX-XX	85	55-1574-XX-XX	342	55-9958-XX-XX	521
15-E020-XX-XX	848	35-7291-XX-XX	85	55-8024-XX-XX	334	55-9968-XX-XX	653
15-E023-XX-XX	504	35-7292-XX-XX	85	55-8025-XX-XX	334	55-9969-XX-XX	653
15-E024-XX-XX	504	35-7305-XX-XX	87	55-8026-XX-XX	334	55-9970-XX-XX	653
15-E025-XX-XX	510	35-7306-XX-XX	87	55-8027-XX-XX	335	55-9971-XX-XX	707
15-E026-XX-XX	510	35-7307-XX-XX	87	55-8028-XX-XX	335	55-9972-XX-XX	655
15-E027-XX-XX	505	35-7308-XX-XX	87	55-8029-XX-XX	335	55-9973-XX-XX	652
15-E028-XX-XX	505	35-7309-XX-XX	87	55-9155-XX-XX	885	55-9974-XX-XX	652
15-E029-XX-XX	511	35-7310-XX-XX	87	55-9156-XX-XX	885	55-9975-XX-XX	652
15-E030-XX-XX	511	35-7323-XX-XX	89	55-9239-XX-XX	733	55-9976-XX-XX	652
15-E031-XX-XX	506	35-7324-XX-XX	89	55-9245-XX-XX	593	55-9977-XX-XX	652
15-E032-XX-XX	506	35-7325-XX-XX	89	55-9280-XX-XX	661	55-9978-XX-XX	652
15-E033-XX-XX	512	35-7326-XX-XX	89	55-9281-XX-XX	661	55-9979-XX-XX	653
15-E034-XX-XX	512	35-7327-XX-XX	89	55-9318-XX-XX	730	55-9980-XX-XX	653
15-E035-XX-XX	606	35-7328-XX-XX	89	55-9319-XX-XX	730	55-9981-XX-XX	653
15-E036-XX-XX	606	35-8035-XX-XX	134	55-9320-XX-XX	731	55-E001-XX-XX	621, 673
15-E041-XX-XX	829	35-8036-XX-XX	134	55-9380-XX-XX	661	55-E002-XX-XX	621, 673
15-E049-XX-XX	828	35-8037-XX-XX	134	55-9428-XX-XX	675	55-E003-XX-XX	621, 673
15-E050-XX-XX	829	35-8038-XX-XX	134	55-9440-XX-XX	733	55-E004-XX-XX	508
15-E104-XX-XX	607	35-A003-XX-XX	85	55-9481-XX-XX	886	55-E005-XX-XX	508
15-E105-XX-XX	607	35-A004-XX-XX	85	55-9488-XX-XX	727	55-E006-XX-XX	624, 679
15-E110-XX-XX	819	35-A005-XX-XX	85	55-9504-XX-XX	716	55-E010-XX-XX	665
15-E111-XX-XX	819	35-A009-XX-XX	87	55-9549-XX-XX	727	55-E011-XX-XX	665
25-9503-XX-XX	887	35-A010-XX-XX	87	55-9620-XX-XX	660	55-E012-XX-XX	722
25-9733-XX-XX	737	35-A011-XX-XX	87	55-9622-XX-XX	594	55-E013-XX-XX	653
25-E000-XX-XX	874	35-A015-XX-XX	89	55-9655-XX-XX	729	55-E014-XX-XX	653
25-E001-XX-XX	874	35-A016-XX-XX	89	55-9656-XX-XX	729	55-E015-XX-XX	653
25-E002-XX-XX	874	35-A017-XX-XX	89	55-9663-XX-XX	657	55-E016-XX-XX	715
25-E003-XX-XX	876	35-A018-XX-XX	87	55-9665-XX-XX	658	55-E017-XX-XX	728

Verzeichnis (Artikelnummer sortiert) / Indice di referenze

Referenz Codice	Seite Pag.	Referenz Codice	Seite Pag.	Referenz Codice	Seite Pag.	Referenz Codice	Seite Pag.
55-E018-XX-XX	728	55-E151-XX-XX	625, 679	71-5608-XX-XX	948	71-5787-XX-XX	949
55-E019-XX-XX	722	55-E162-XX-XX	513	71-5609-XX-XX	948	71-5788-XX-XX	949
55-E020-XX-XX	665	55-E163-XX-XX	513	71-5617-XX-XX	949	71-5789-XX-XX	949
55-E022-XX-XX	482, 708	60-3239-XX-XX	752	71-5618-XX-XX	949	71-5953-XX-XX	84, 86, 88
55-E023-XX-XX	482, 708	60-9809-XX-XX	753	71-5630-XX-XX	949	71-5959-XX-XX	926
55-E024-XX-XX	484, 743	60-9913-XX-XX	754	71-5646-XX-XX	949	71-5961-XX-XX	926
55-E025-XX-XX	698	60-9996-XX-XX	754	71-5647-XX-XX	949	71-6099-XX-XX	949
55-E026-XX-XX	698	60-E000-XX-XX	751	71-5658-XX-XX	949	71-6273-XX-XX	950
55-E027-XX-XX	698	60-E057-XX-XX	745	71-5738-XX-XX	403	71-6274-XX-XX	950
55-E028-XX-XX	698	60-E082-XX-XX	755	71-5739-XX-XX	403	71-6275-XX-XX	949
55-E029-XX-XX	698	60-E102-XX-XX	750	71-5740-XX-XX	403	71-6276-XX-XX	950
55-E030-XX-XX	698	71-2232-XX-XX	948	71-5741-XX-XX	402	71-6277-XX-XX	950
55-E031-XX-XX	699	71-3223-XX-XX	948	71-5742-XX-XX	402	71-6279-XX-XX	950
55-E032-XX-XX	699	71-3531-XX-XX	948	71-5743-XX-XX	402	71-6280-XX-XX	950
55-E033-XX-XX	699	71-3885-XX-XX	329	71-5744-XX-XX	405	71-6281-XX-XX	949
55-E034-XX-XX	515	71-3886-XX-XX	329	71-5745-XX-XX	405	71-6282-XX-XX	950
55-E035-XX-XX	699	71-3887-XX-XX	329	71-5746-XX-XX	405	71-6283-XX-XX	950
55-E036-XX-XX	699	71-3888-XX-XX	329	71-5747-XX-XX	404	71-6285-XX-XX	950
55-E037-XX-XX	699	71-4032-XX-XX	329	71-5748-XX-XX	404	71-6286-XX-XX	950
55-E038-XX-XX	661	71-4033-XX-XX	329	71-5749-XX-XX	404	71-6287-XX-XX	88, 89
55-E039-XX-XX	507	71-4393-XX-XX	948	71-5753-XX-XX	406	71-6288-XX-XX	950
55-E040-XX-XX	507	71-4396-XX-XX	239, 241, 242	71-5754-XX-XX	406	71-6289-XX-XX	950
55-E041-XX-XX	513	71-4398-XX-XX	948	71-5755-XX-XX	406	71-6290-XX-XX	950
55-E042-XX-XX	507	71-4695-XX-XX	948	71-5756-XX-XX	409	71-6436-XX-XX	950
55-E043-XX-XX	507	71-4754-XX-XX	948	71-5757-XX-XX	401, 408, 410	71-6437-XX-XX	950
55-E050-XX-XX	513	71-5086-XX-XX	329	71-5758-XX-XX	401, 408, 410	71-6438-XX-XX	950
55-E051-XX-XX	514	71-5087-XX-XX	329	71-5759-XX-XX	409	71-6481-XX-XX	950
55-E052-XX-XX	514	71-5156-XX-XX	329	71-5760-XX-XX	409	71-6607-XX-XX	950
55-E054-XX-XX	715	71-5157-XX-XX	329	71-5761-XX-XX	409	71-6608-XX-XX	950
55-E055-XX-XX	705	71-5166-XX-XX	948	71-5762-XX-XX	411	71-7520-XX-XX	113, 115, 117, 146, 154, 359, 365, 362, 367, 369
55-E056-XX-XX	705	71-5167-XX-XX	948	71-5763-XX-XX	411		
55-E057-XX-XX	871	71-5171-XX-XX	229, 323	71-5764-XX-XX	411	71-7521-XX-XX	119, 154, 359, 362, 365, 367, 369
55-E058-XX-XX	871	71-5174-XX-XX	948	71-5765-XX-XX	949		
55-E059-XX-XX	871	71-5175-XX-XX	948	71-5766-XX-XX	949		
55-E060-XX-XX	873	71-5201-XX-XX	948	71-5767-XX-XX	949		
55-E061-XX-XX	873	71-5210-XX-XX	948	71-5768-XX-XX	949	71-7522-XX-XX	950
55-E062-XX-XX	873	71-5211-XX-XX	948	71-5770-XX-XX	949	71-7523-XX-XX	950
55-E063-XX-XX	869	71-5213-XX-XX	948	71-5771-XX-XX	402, 403, 409	71-7524-XX-XX	950
55-E064-XX-XX	869	71-5214-XX-XX	114	71-5772-XX-XX	402, 403, 409	71-7534-XX-XX	950
55-E065-XX-XX	869	71-5215-XX-XX	114	71-5773-XX-XX	402, 403, 409	71-7535-XX-XX	118
55-E066-XX-XX	875	71-5216-XX-XX	116			71-7536-XX-XX	118
55-E067-XX-XX	875	71-5217-XX-XX	116	71-5774-XX-XX	402, 403, 409	71-7537-XX-XX	118
55-E068-XX-XX	875	71-5218-XX-XX	114, 116			71-7538-XX-XX	118
55-E069-XX-XX	877	71-5219-XX-XX	114	71-5775-XX-XX	404, 405	71-7539-XX-XX	118
55-E071-XX-XX	515	71-5220-XX-XX	114	71-5776-XX-XX	404, 405	71-7540-XX-XX	118
55-E074-XX-XX	521	71-5221-XX-XX	116	71-5777-XX-XX	404, 405	71-7541-XX-XX	118
55-E076-XX-XX	509	71-5222-XX-XX	116	71-5778-XX-XX	404, 405	71-7542-XX-XX	118
55-E087-XX-XX	883	71-5223-XX-XX	114, 116	71-5779-XX-XX	406, 407	71-7543-XX-XX	118
55-E088-XX-XX	883	71-5224-XX-XX	112, 114	71-5780-XX-XX	406, 407	71-7544-XX-XX	118
55-E092-XX-XX	723	71-5225-XX-XX	115, 117	71-5781-XX-XX	406, 407	71-7545-XX-XX	118
55-E101-XX-XX	521	71-5227-XX-XX	114	71-5782-XX-XX	401, 408, 410	71-7546-XX-XX	119
55-E102-XX-XX	675	71-5228-XX-XX	115			71-7547-XX-XX	119
55-E117-XX-XX	490	71-5229-XX-XX	112, 117	71-5783-XX-XX	401, 408, 410	71-7624-XX-XX	146
55-E118-XX-XX	490	71-5230-XX-XX	117			71-7625-XX-XX	146
55-E119-XX-XX	491	71-5231-XX-XX	115	71-5784-XX-XX	401	71-7626-XX-XX	146
55-E120-XX-XX	491	71-5232-XX-XX	117	71-5785-XX-XX	401	71-7627-XX-XX	147
55-E148-XX-XX	669	71-5486-XX-XX	406, 407	71-5786-XX-XX	949	71-7629-XX-XX	146
55-E149-XX-XX	669	71-5511-XX-XX	948				
55-E150-XX-XX	669						

Verzeichnis (Artikelnummer sortiert) / Indice di referenze

Referenz Codice	Seite Pag.	Referenz Codice	Seite Pag.	Referenz Codice	Seite Pag.	Referenz Codice	Seite Pag.
71-7630-XX-XX	150	71-8125-XX-XX	388	71-E004-XX-XX	953	71-E263-XX-XX	948
71-7631-XX-XX	150	71-8126-XX-XX	388	71-E005-XX-XX	953	71-E264-XX-XX	955
71-7632-XX-XX	150	71-8127-XX-XX	388	71-E006-XX-XX	953	71-E278-XX-XX	955
71-7633-XX-XX	150, 155	71-8128-XX-XX	388	71-E008-XX-XX	952	71-E279-XX-XX	955
71-7634-XX-XX	150	71-8129-XX-XX	388	71-E009-XX-XX	952	71-E280-XX-XX	955
71-7637-XX-XX	146, 150, 154	71-8130-XX-XX	388	71-E011-XX-XX	935	71-E281-XX-XX	955
71-7639-XX-XX	147	71-8131-XX-XX	388	71-E012-XX-XX	953	71-E282-XX-XX	955
71-7640-XX-XX	407	71-8132-XX-XX	388	71-E013-XX-XX	953	71-E284-XX-XX	955
71-7646-XX-XX	147, 151, 155	71-8197-XX-XX	119	71-E016-XX-XX	953	71-E292-XX-XX	955
71-7647-XX-XX	147, 151, 155	71-8224-XX-XX	949	71-E018-XX-XX	953	71-E294-XX-XX	955
71-7648-XX-XX	147, 151, 155	71-8226-XX-XX	949	71-E028-XX-XX	953	71-E354-XX-XX	953
71-7656-XX-XX	950	71-8227-XX-XX	952	71-E029-XX-XX	953	71-E355-XX-XX	953
71-7676-XX-XX	146	71-8228-XX-XX	952	71-E030-XX-XX	953	71-E356-XX-XX	953
71-7698-XX-XX	951	71-8246-XX-XX	952	71-E031-XX-XX	952	71-E357-XX-XX	956
71-7705-XX-XX	146, 150	71-8332-XX-XX	866, 868, 870, 872, 874, 876	71-E034-XX-XX	953	71-E358-XX-XX	956
71-7706-XX-XX	150	71-9199-XX-XX	952	71-E035-XX-XX	953	71-E359-XX-XX	956
71-7735-XX-XX	951	71-9262-XX-XX	952	71-E036-XX-XX	953	71-E360-XX-XX	956
71-7736-XX-XX	951	71-9746-XX-XX	952	71-E039-XX-XX	953	71-E361-XX-XX	956
71-7737-XX-XX	940	71-9955-XX-XX	952	71-E041-XX-XX	953	71-E362-XX-XX	956
71-7747-XX-XX	951	71-9957-XX-XX	953	71-E052-XX-XX	953	71-E363-XX-XX	953
71-7757-XX-XX	951	71-9997-XX-XX	952	71-E058-XX-XX	557, 558	71-E364-XX-XX	953
71-7841-XX-XX	951	71-9998-XX-XX	952	71-E065-XX-XX	954	71-E366-XX-XX	956
71-7891-XX-XX	950	71-9999-XX-XX	952	71-E069-XX-XX	935	71-E367-XX-XX	956
71-7892-XX-XX	950	71-A177-XX-XX	948	71-E070-XX-XX	935	81-3239-XX-XX	752
71-7893-XX-XX	949	71-A223-XX-XX	952	71-E071-XX-XX	954	81-9914-XX-XX	753
71-7894-XX-XX	951	71-A228-XX-XX	952	71-E078-XX-XX	954	81-9915-XX-XX	753
71-7895-XX-XX	951	71-A237-XX-XX	926	71-E090-XX-XX	954	81-E000-XX-XX	754
71-8030-XX-XX	146, 150, 154	71-A228-XX-XX	952	71-E092-XX-XX	952	81-E102-XX-XX	750
71-8031-XX-XX	146, 150, 154	71-A237-XX-XX	926	71-E093-XX-XX	954	81-E103-XX-XX	750
71-8032-XX-XX	146, 150, 154	71-A238-XX-XX	926	71-E095-XX-XX	954	90-1720-XX-XX	242
71-8043-XX-XX	154	71-A242-XX-XX	926	71-E104-XX-XX	953	90-1722-XX-XX	242
71-8044-XX-XX	154	71-A243-XX-XX	926	71-E105-XX-XX	953	90-2899-XX-XX	188
71-8045-XX-XX	154	71-A244-XX-XX	147	71-E110-XX-XX	953	90-2902-XX-XX	241
71-8046-XX-XX	154	71-A245-XX-XX	147	71-E111-XX-XX	953	90-2903-XX-XX	241
71-8047-XX-XX	155	71-A246-XX-XX	147	71-E112-XX-XX	954	90-3208-XX-XX	325
71-8050-XX-XX	926	71-A247-XX-XX	147	71-E117-XX-XX	954	90-3209-XX-XX	325
71-8056-XX-XX	929	71-A248-XX-XX	151	71-E118-XX-XX	953	90-3210-XX-XX	325
71-8082-XX-XX	407	71-A249-XX-XX	151	71-E122-XX-XX	954	90-3211-XX-XX	325
71-8083-XX-XX	407	71-A250-XX-XX	151	71-E123-XX-XX	948	90-3529-XX-XX	325
71-8084-XX-XX	407	71-A251-XX-XX	151	71-E133-XX-XX	954	90-3530-XX-XX	325
71-8092-XX-XX	951	71-A252-XX-XX	155	71-E135-XX-XX	954	90-3925-XX-XX	188
71-8093-XX-XX	951	71-A253-XX-XX	155	71-E139-XX-XX	954	90-3926-XX-XX	188
71-8094-XX-XX	951	71-A258-XX-XX	941	71-E141-XX-XX	954	90-3927-XX-XX	189
71-8095-XX-XX	951	71-A259-XX-XX	941	71-E143-XX-XX	954	90-3928-XX-XX	189
71-8096-XX-XX	951	71-A260-XX-XX	940	71-E145-XX-XX	954	90-3929-XX-XX	189
71-8097-XX-XX	951	71-A261-XX-XX	940	71-E155-XX-XX	955	90-3930-XX-XX	189
71-8098-XX-XX	951	71-A263-XX-XX	953	71-E157-XX-XX	955	90-4781-XX-XX	235
71-8099-XX-XX	951	71-A264-XX-XX	953	71-E164-XX-XX	952	90-4782-XX-XX	235
71-8100-XX-XX	951	71-A296-XX-XX	388	71-E200-XX-XX	955	90-4783-XX-XX	235
71-8101-XX-XX	951	71-A334-XX-XX	953	71-E213-XX-XX	952	90-4788-XX-XX	235
71-8112-XX-XX	951	71-A775-XX-XX	334, 335	71-E225-XX-XX	955	90-4789-XX-XX	235
71-8113-XX-XX	952	71-A776-XX-XX	950	71-E226-XX-XX	955	90-4790-XX-XX	235
71-8114-XX-XX	952	71-A854-XX-XX	950	71-E227-XX-XX	955	90-4791-XX-XX	235
71-8115-XX-XX	926	71-A855-XX-XX	950	71-E234-XX-XX	955	90-4792-XX-XX	235
71-8124-XX-XX	154	71-A938-XX-XX	359, 362, 363, 367, 369	71-E235-XX-XX	955	90-4793-XX-XX	235
		71-E000-XX-XX	953	71-E259-XX-XX	954	90-4880-XX-XX	188
		71-E001-XX-XX	953	71-E260-XX-XX	954	90-4881-XX-XX	188
		71-E002-XX-XX	952	71-E261-XX-XX	954	90-4883-XX-XX	188
				71-E262-XX-XX	954	90-4885-XX-XX	189

Verzeichnis (Artikelnummer sortiert) / Indice di referenze

Referenz Codice	Seite Pag.	Referenz Codice	Seite Pag.	Referenz Codice	Seite Pag.	Referenz Codice	Seite Pag.
90-4886-XX-XX	189	90-6384-XX-XX	258	90-7215-XX-XX	266	90-A026-XX-XX	233
90-5922-XX-XX	272	90-6385-XX-XX	258	90-7216-XX-XX	266	90-A027-XX-XX	233
90-5923-XX-XX	272	90-6386-XX-XX	258	90-7217-XX-XX	266	90-A028-XX-XX	233
90-5924-XX-XX	272	90-6387-XX-XX	258	90-7218-XX-XX	266	90-A029-XX-XX	233
90-5925-XX-XX	272	90-6388-XX-XX	259	90-7219-XX-XX	266	90-A030-XX-XX	233
90-5926-XX-XX	273	90-6389-XX-XX	259	90-7220-XX-XX	266	90-A031-XX-XX	233
90-5927-XX-XX	273	90-6390-XX-XX	259	90-7221-XX-XX	266	90-A032-XX-XX	184
90-5928-XX-XX	273	90-6391-XX-XX	259	90-7222-XX-XX	266	90-A033-XX-XX	184
90-5929-XX-XX	273	90-6392-XX-XX	259	90-7223-XX-XX	266	90-A034-XX-XX	184
90-6161-XX-XX	254	90-6393-XX-XX	259	90-7224-XX-XX	266	90-A035-XX-XX	184
90-6162-XX-XX	254	90-6673-XX-XX	254	90-7225-XX-XX	266	90-A036-XX-XX	184
90-6163-XX-XX	254	90-6674-XX-XX	254	90-7226-XX-XX	266	90-A037-XX-XX	184
90-6164-XX-XX	254	90-6675-XX-XX	254	90-7227-XX-XX	266	90-A038-XX-XX	94
90-6165-XX-XX	254	90-6676-XX-XX	254	90-7228-XX-XX	266	90-A039-XX-XX	94
90-6166-XX-XX	254	90-6677-XX-XX	254	90-7229-XX-XX	266	90-A040-XX-XX	96
90-6167-XX-XX	256	90-6678-XX-XX	254	90-7230-XX-XX	266	90-A041-XX-XX	96
90-6168-XX-XX	256	90-6679-XX-XX	255	90-7231-XX-XX	266	90-A042-XX-XX	284
90-6169-XX-XX	256	90-6680-XX-XX	255	90-7273-XX-XX	93	90-A043-XX-XX	285
90-6170-XX-XX	256	90-6681-XX-XX	255	90-7274-XX-XX	93	90-A060-XX-XX	93
90-6171-XX-XX	256	90-6682-XX-XX	256	90-7275-XX-XX	93	90-A061-XX-XX	93
90-6172-XX-XX	256	90-6683-XX-XX	256	90-7276-XX-XX	93	90-A062-XX-XX	93
90-6173-XX-XX	257	90-6684-XX-XX	256	90-7277-XX-XX	93	91-2379-XX-XX	434
90-6174-XX-XX	257	90-6685-XX-XX	256	90-7278-XX-XX	93	91-5571-XX-XX	436
90-6175-XX-XX	257	90-6686-XX-XX	256	90-7359-XX-XX	137	91-5572-XX-XX	436
90-6349-XX-XX	257	90-6687-XX-XX	256	90-7360-XX-XX	137	91-5573-XX-XX	436
90-6350-XX-XX	257	90-6688-XX-XX	257	90-7361-XX-XX	137	91-6607-XX-XX	418
90-6351-XX-XX	257	90-6689-XX-XX	257	90-7362-XX-XX	137	91-6608-XX-XX	419
90-6352-XX-XX	259	90-6690-XX-XX	257	90-7682-XX-XX	239	91-6609-XX-XX	420
90-6353-XX-XX	259	90-6691-XX-XX	258	90-7804-XX-XX	255	91-6610-XX-XX	421
90-6354-XX-XX	259	90-6692-XX-XX	258	90-7805-XX-XX	255	91-7926-XX-XX	434
90-6355-XX-XX	259	90-6693-XX-XX	258	90-7835-XX-XX	284	91-7927-XX-XX	434
90-6356-XX-XX	259	90-6694-XX-XX	258	90-7836-XX-XX	284	91-7930-XX-XX	437
90-6357-XX-XX	259	90-6695-XX-XX	258	90-7839-XX-XX	284	91-7931-XX-XX	437
90-6358-XX-XX	260	90-6696-XX-XX	258	90-7840-XX-XX	284	91-7932-XX-XX	438
90-6359-XX-XX	260	90-6697-XX-XX	259	90-8001-XX-XX	285	91-7933-XX-XX	438
90-6360-XX-XX	260	90-6698-XX-XX	259	90-8002-XX-XX	285	91-7934-XX-XX	434
90-6361-XX-XX	260	90-6699-XX-XX	259	90-8003-XX-XX	285	91-7935-XX-XX	434
90-6362-XX-XX	260	90-7002-XX-XX	260	90-8007-XX-XX	95	91-7936-XX-XX	434
90-6363-XX-XX	260	90-7005-XX-XX	260	90-8008-XX-XX	95	91-7937-XX-XX	434
90-6364-XX-XX	254	90-7006-XX-XX	260	90-8009-XX-XX	95	91-7938-XX-XX	434
90-6365-XX-XX	254	90-7098-XX-XX	263	90-8010-XX-XX	95	91-7939-XX-XX	434
90-6366-XX-XX	254	90-7099-XX-XX	263	90-8011-XX-XX	95	91-7940-XX-XX	440
90-6367-XX-XX	254	90-7100-XX-XX	263	90-8012-XX-XX	95	91-7941-XX-XX	440
90-6368-XX-XX	254	90-7101-XX-XX	263	90-8013-XX-XX	92	91-7942-XX-XX	441
90-6369-XX-XX	254	90-7161-XX-XX	263	90-8014-XX-XX	92	91-7943-XX-XX	441
90-6370-XX-XX	255	90-7169-XX-XX	263	90-8078-XX-XX	233	91-7944-XX-XX	442
90-6371-XX-XX	255	90-7184-XX-XX	263	90-8079-XX-XX	233	91-7945-XX-XX	442
90-6372-XX-XX	255	90-7185-XX-XX	263	90-8080-XX-XX	233	91-7946-XX-XX	443
90-6373-XX-XX	255	90-7186-XX-XX	263	90-8105-XX-XX	284	91-7947-XX-XX	443
90-6374-XX-XX	255	90-7187-XX-XX	263	90-8205-XX-XX	179	91-7948-XX-XX	444
90-6375-XX-XX	255	90-7188-XX-XX	263	90-8206-XX-XX	179	91-7949-XX-XX	444
90-6376-XX-XX	256	90-7189-XX-XX	263	90-A003-XX-XX	93	91-7950-XX-XX	445
90-6377-XX-XX	256	90-7190-XX-XX	263	90-A004-XX-XX	93	91-7951-XX-XX	445
90-6378-XX-XX	256	90-7191-XX-XX	263	90-A005-XX-XX	93	91-7964-XX-XX	418
90-6379-XX-XX	256	90-7192-XX-XX	263	90-A009-XX-XX	95	91-7965-XX-XX	419
90-6380-XX-XX	256	90-7193-XX-XX	263	90-A010-XX-XX	95	91-7966-XX-XX	420
90-6381-XX-XX	256	90-7194-XX-XX	263	90-A011-XX-XX	95	91-7967-XX-XX	421
90-6382-XX-XX	258	90-7195-XX-XX	263	90-A019-XX-XX	96	91-7968-XX-XX	418
90-6383-XX-XX	258	90-7214-XX-XX	266	90-A021-XX-XX	94	91-7969-XX-XX	419

Verzeichnis (Artikelnummer sortiert) / Indice di referenze

Referenz Codice	Seite Pag.	Referenz Codice	Seite Pag.	Referenz Codice	Seite Pag.	Referenz Codice	Seite Pag.
91-7970-XX-XX	420	AH11-XXXXXXXXXX	168	AS11-XXXXXXXXXX	480, 570, 810, 838	AW27-XXXXXXXXXX	63, 381
91-7971-XX-XX	421	AH12-XXXXXXXXXX	168	AS12-XXXXXXXXXX	480, 570, 810, 838	AW28-XXXXXXXXXX	64, 382
91-A000-XX-XX	422	AH13-XXXXXXXXXX	168	AS13-XXXXXXXXXX	481, 571, 811, 839	AW29-XXXXXXXXXX	64, 382
91-A001-XX-XX	423	AH14-XXXXXXXXXX	168	AS14-XXXXXXXXXX	483, 709	AW31-XXXXXXXXXX	64, 382
91-A002-XX-XX	422	AH15-XXXXXXXXXX	169	AS15-XXXXXXXXXX	483, 709	AW32-XXXXXXXXXX	64, 382
91-A003-XX-XX	423	AH16-XXXXXXXXXX	169	AS16-XXXXXXXXXX	484, 743	AW33-XXXXXXXXXX	68, 386
91-A004-XX-XX	422	AH17-XXXXXXXXXX	169	AT11-XXXXXXXXXX	463, 643	AW34-XXXXXXXXXX	68, 386
91-A005-XX-XX	423	AH18-XXXXXXXXXX	169	AT12-XXXXXXXXXX	463, 643	AW35-XXXXXXXXXX	66, 384
ACT-9105-XX-XX	84, 86, 88	AH19-XXXXXXXXXX	170	AT13-XXXXXXXXXX	463, 643	AW36-XXXXXXXXXX	66, 384
AG11-XXXXXXXXXX	205, 207	AH21-XXXXXXXXXX	170	AT14-XXXXXXXXXX	461, 601	AW37-XXXXXXXXXX	69, 387
AG12-XXXXXXXXXX	205, 207	AH22-XXXXXXXXXX	174	AT15-XXXXXXXXXX	461, 601	AW38-XXXXXXXXXX	69, 387
AG13-XXXXXXXXXX	210	AH23-XXXXXXXXXX	174	AT16-XXXXXXXXXX	461, 601	AW39-XXXXXXXXXX	67, 385
AG14-XXXXXXXXXX	210	AH24-XXXXXXXXXX	174	AT17-XXXXXXXXXX	459, 565	AW41-XXXXXXXXXX	67, 385
AG15-XXXXXXXXXX	208	AH25-XXXXXXXXXX	174	AT18-XXXXXXXXXX	459, 565	AW42-XXXXXXXXXX	60, 378
AG16-XXXXXXXXXX	212	AH26-XXXXXXXXXX	175	AT19-XXXXXXXXXX	465, 761	AW43-XXXXXXXXXX	60, 378
AG17-XXXXXXXXXX	208	AH27-XXXXXXXXXX	175	AT21-XXXXXXXXXX	467, 763	AW44-XXXXXXXXXX	60, 378
AG19-XXXXXXXXXX	205, 207	AH28-XXXXXXXXXX	175	AT22-XXXXXXXXXX	469, 847	AW45-XXXXXXXXXX	60, 378
AG21-XXXXXXXXXX	205, 207	AH29-XXXXXXXXXX	175	AU11-XXXXXXXXXX	290	AW46-XXXXXXXXXX	60, 378
AG22-XXXXXXXXXX	212	AH31-XXXXXXXXXX	172	AU12-XXXXXXXXXX	290	AW47-XXXXXXXXXX	60, 378
AG23-XXXXXXXXXX	224	AH32-XXXXXXXXXX	172	AU13-XXXXXXXXXX	291	AW48-XXXXXXXXXX	62, 360
AG24-XXXXXXXXXX	225	AH33-XXXXXXXXXX	172	AU14-XXXXXXXXXX	291	AW49-XXXXXXXXXX	62, 360
AG25-XXXXXXXXXX	226	AH34-XXXXXXXXXX	172	AU15-XXXXXXXXXX	290	AW51-XXXXXXXXXX	62, 360
AG26-XXXXXXXXXX	225	AH35-XXXXXXXXXX	173	AU16-XXXXXXXXXX	291	AW52-XXXXXXXXXX	62, 360
AG27-XXXXXXXXXX	224	AH36-XXXXXXXXXX	173	AU17-XXXXXXXXXX	292	AW53-XXXXXXXXXX	62, 360
AG28-XXXXXXXXXX	225	AH37-XXXXXXXXXX	173	AU18-XXXXXXXXXX	292	AW54-XXXXXXXXXX	62, 360
AG29-XXXXXXXXXX	226	AH38-XXXXXXXXXX	173	AU19-XXXXXXXXXX	293	AW55-XXXXXXXXXX	61, 379
AG31-XXXXXXXXXX	225	AI11-XXXXXXXXXX	462, 642	AU21-XXXXXXXXXX	293	AW56-XXXXXXXXXX	61, 379
AG32-XXXXXXXXXX	229, 323	AI12-XXXXXXXXXX	462, 642	AU22-XXXXXXXXXX	292	AW57-XXXXXXXXXX	61, 379
AG33-XXXXXXXXXX	206	AI13-XXXXXXXXXX	462, 642	AU23-XXXXXXXXXX	293	AW58-XXXXXXXXXX	61, 379
AG34-XXXXXXXXXX	206	AI14-XXXXXXXXXX	460, 600	AV11-XXXXXXXXXX	47, 103, 311	AW59-XXXXXXXXXX	61, 379
AG36-XXXXXXXXXX	209	AI15-XXXXXXXXXX	460, 600	AV12-XXXXXXXXXX	47, 103, 311	AW61-XXXXXXXXXX	61, 379
AG37-XXXXXXXXXX	211	AI16-XXXXXXXXXX	460, 600	AV13-XXXXXXXXXX	47, 51, 103, 310, 311	ACT-9165-XX-XX	956
AG38-XXXXXXXXXX	206	AI17-XXXXXXXXXX	564, 458	AV14-XXXXXXXXXX	50, 299	DN-1600-XX-XX	236
AG39-XXXXXXXXXX	206	AI18-XXXXXXXXXX	564, 458	AV15-XXXXXXXXXX	50, 299	DN-1601-XX-XX	237
AG41-XXXXXXXXXX	209	AI19-XXXXXXXXXX	464, 760	AV16-XXXXXXXXXX	50, 299	DN-1602-XX-XX	237
AG42-XXXXXXXXXX	228	AI21-XXXXXXXXXX	466, 762	AV17-XXXXXXXXXX	51, 310	EM01-0001	956
AG43-XXXXXXXXXX	213	AI22-XXXXXXXXXX	468, 846	AV19-XXXXXXXXXX	19, 105, 135	EM01-0002	956
AG44-XXXXXXXXXX	213	AI23-XXXXXXXXXX	464, 760	AV21-XXXXXXXXXX	48, 104	EM01-0003	956
AG45-XXXXXXXXXX	215	AI24-XXXXXXXXXX	466, 762	AW11-XXXXXXXXXX	59, 377	EM01-0005	957
AG46-XXXXXXXXXX	215	AI25-XXXXXXXXXX	468, 846	AW12-XXXXXXXXXX	59, 377	EM01-0006	957
AG47-XXXXXXXXXX	215	AK11-XXXXXXXXXX	358	AW13-XXXXXXXXXX	59, 377	EM01-0007	957
AG48-XXXXXXXXXX	215	AK12-XXXXXXXXXX	358	AW14-XXXXXXXXXX	59, 377	EM01-0008	957
AG49-XXXXXXXXXX	217, 218	AK13-XXXXXXXXXX	358	AW15-XXXXXXXXXX	59, 377	EM01-XXXXXXX	905, 906
AG51-XXXXXXXXXX	217	AK14-XXXXXXXXXX	360	AW16-XXXXXXXXXX	59, 377	EM02-0004	957
AG52-XXXXXXXXXX	217	AK15-XXXXXXXXXX	361	AW17-XXXXXXXXXX	65, 383	EM02-XXXXXXXX	907, 908
AG53-XXXXXXXXXX	217	AK16-XXXXXXXXXX	361	AW18-XXXXXXXXXX	65, 383	EM03-XXXXXXXX	909
AG54-XXXXXXXXXX	218	AK18-XXXXXXXXXX	366	AW19-XXXXXXXXXX	65, 383	EM04-0001	957
AG55-XXXXXXXXXX	218	AK19-XXXXXXXXXX	366	AW21-XXXXXXXXXX	65, 383	EM04-0003	957
AG56-XXXXXXXXXX	220	AK21-XXXXXXXXXX	366	AW22-XXXXXXXXXX	63, 381	EM04-XXXXXXXX	900
AG57-XXXXXXXXXX	220	AK23-XXXXXXXXXX	363	AW23-XXXXXXXXXX	63, 381	EM05-XXXXXXXX	901
AG58-XXXXXXXXXX	222	AK24-XXXXXXXXXX	364	AW24-XXXXXXXXXX	63, 381	EM06-0001	921
AG59-XXXXXXXXXX	223	AK25-XXXXXXXXXX	368	AW25-XXXXXXXXXX	63, 381	EM06-0002	921
AG61-XXXXXXXXXX	214	AL11-XXXXXXXXXX	685, 851	AW26-XXXXXXXXXX	63, 381	EM06-0003	921
AG62-XXXXXXXXXX	214	AL12-XXXXXXXXXX	685, 851			EM06-XXXXXXXX	909
AG63-XXXXXXXXXX	216	AN11-XXXXXXXXXX	542			EM08-XXXXXXXX	913
AG64-XXXXXXXXXX	216	AN12-XXXXXXXXXX	543			EM10-XXXXXXXX	911
AG65-XXXXXXXXXX	219	AN13-XXXXXXXXXX	544			EP-0356-XX-XX	340
AG66-XXXXXXXXXX	221	AN14-XXXXXXXXXX	544				
AG67-XXXXXXXXXX	221						

Wichtige Informationen

Informazione importante

Aufgrund der ständigen technischen Weiterentwicklung von LEDs können die technischen Eigenschaften der Produkte variieren. Wir empfehlen, das technische Datenblatt auf der Website (www.leds-c4.com) abzurufen, um immer die aktuelle Version zu erhalten.

A causa della costante evoluzione tecnologica del LED, i dati tecnici relativi ai prodotti possono variare nel tempo. Si consiglia di consultare la scheda tecnica nella pagina web (www.leds-c4.com) per ottenere la versione aggiornata.

LEDS C4 S.A.
Afores s/n 25750 Torà
Lleida – Spain
+34 973 468 100
leds-c4@leds-c4.com

Customer Service

SPAIN

+ 34 973 468 101
spain@leds-c4.com

UNITED KINGDOM

Free-phone: 0808 234 2641
uk@leds-c4.com

FRANCE

+ 34 973 468 130
france@leds-c4.com

GERMANY

+49 209 882 99 021
deutschland@leds-c4.com

ITALY

Toll-free: 800 784 275
italia@leds-c4.com

PORTUGAL

+34 973 468 102
portugal@leds-c4.com

EUROPE

+ 34 973 468 102
europe@leds-c4.com

ASIA PACIFIC

+ 34 973 468 116
asiapacific@leds-c4.com

AFRICA

+ 34 973 468 116
africa@leds-c4.com

LATIN AMERICA

+ 34 973 468 115
latinamerica@leds-c4.com

CANADA

Toll-free: + 1-866-5636666
CustomerServiceUS@leds-c4.com

UNITED STATES

Toll-free: + 1-888-3710243
CustomerServiceUS@leds-c4.com

Madrid

LEDS-C4 Centro Innovación Madrid
Pol. Industrial Ventorro del Cano
Calle Cercedilla 11 Nave1,
28925 Alcorcón, Madrid

Middle East

Fortune Executive Tower
Cluster T - Office 204
Jumeirah Lake Towers
PO 336910 Dubai - UAE
+ 971 4458 4272
middleeast@leds-c4.com

Asia Pacific

8 Robinson Road
#03-00 ASO Building
048544 SINGAPORE
+65 8133 5024

South Africa

Office 111, Regus Business Centre
(AMR Building)
3 Concorde Road East
2007 Bedfordview SOUTH AFRICA
+27100075231
SouthAfrica@leds-c4.com

Germany

Wissenschaftspark Gelsenkirchen
Leds C4 Deutschland GmbH
Munscheidstraße 14
45886 Gelsenkirchen GERMANY
+49 209 882 99 021
deutschland@leds-c4.com

Poland

Leds Polska Sp. z o.o.
Ul. Kasztanowa 44
05-816 Michalowice-Wies POLAND
+ 48 71 733 64 01
biuro@leds-c4.pl

Colombia

Carrera 13, A #89-53
Oficina 101 – Edificio Farallones
110221 Bogotá COLOMBIA
+ 571 6386012





Press

comunicacion@leds-c4.com

Suppliers

+ 34 973 468 113

LEDS-C4.COM

 Instagram: [instagram.com/leds_c4/](https://www.instagram.com/leds_c4/)
 Facebook: [facebook.com/ledsc4.sa](https://www.facebook.com/ledsc4.sa)
 LinkedIn: [linkedin.com/company/leds-c4](https://www.linkedin.com/company/leds-c4)
 Twitter: twitter.com/ledsc4
 Pinterest: [pinterest.com/ledsc4/](https://www.pinterest.com/ledsc4/)

AFORES S/N 25750 TORÀ
LLEIDA, SPAIN

(+34) 973 468 100
LEDS-C4.COM